



specification: imp001

version 20140812

1. Product description

1.1 General description

The imp001 is a complete wireless network node in a card form factor. It works in conjunction with the imp service to allow easy connection of any device to the internet.

One of the big advantages of having WiFi inside a user-removable card is all the wireless regulatory approvals happen at the card level. This relieves the need for wireless regulator certification at the product level.

1.2 Features

- 802.11 b/g/n WiFi
 - 20MHz 11n channels, 1 x 1
 - +16.75dBm max output power (802.11b)
 - -97dBm typical sensitivity (1Mbps)
 - Integrated antenna with 2.5dBi max gain
- 32-bit Cortex M3 processor
 - Robust embedded operating system with fail-safe firmware updates
 - Virtual machine for vendor firmware
- Embedded bi-color red/green LED for status indication
- Embedded phototransistor for our patent-pending BlinkUp optical configuration technology
- 6 user selectable I/Os
 - GPIO, PWM, Analog input & output
 - SPI (2 channels), UART (3 channels), I2C (2 channels)
- Low power 6µA sleep mode
- FCC, CE, IC C-Tick certified

Ordering information

Part number	Description
imp001-us-b	imp card with built-in antenna, US/CAN version, bulk pack
imp001-eu-b	imp card with built-in antenna, EU/AUS/NZ version, bulk pack

2. Imp terminology

Term	Description
Electric Imp	http://electricimp.com/aboutus/
API	The Application Programming Interface through which imp scripts may access hardware and cloud functions
BlinkUp	Our patent-pending optical programming process for commissioning an imp using a smart device (phone or tablet)
Commissioning	Initializing an imp by associating it with a user account and WiFi credentials, usually via BlinkUp
Blessing	The process by which an imp card or module becomes associated with host hardware
Server	The electric imp cloud service with which imps communicate
Firmware	User-defined code that runs within a virtual machine. Device Firmware runs on the Electric Imp Hardware. Agent Firmware runs in the Electric Imp Cloud.
Agent	A virtual machine within the Electric Imp Cloud. Each Electric Imp device is paired with exactly one Agent.
IDE	Integrated Development Environment. Used to develop and maintain your Electric Imp Firmware. Push new code to devices from any place at any time.
Ops Console	Gain more insight into your factory production lines and scale to millions of devices

3. Pin assignments

Rear view (gold fingers facing up)

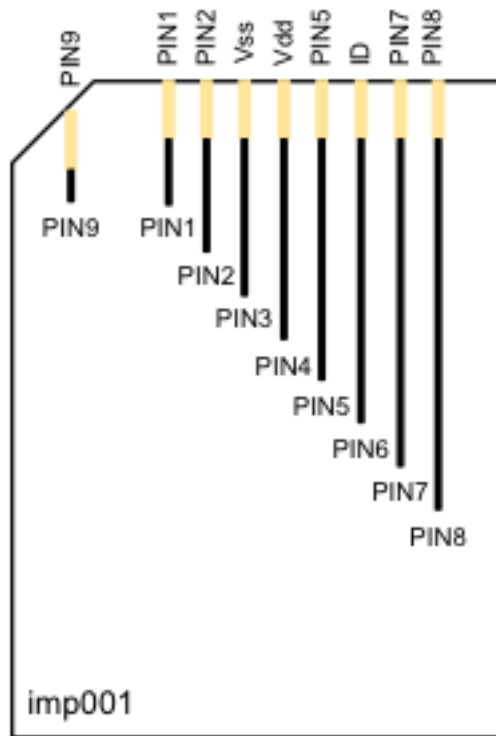

4. Pin description

Pin number	Pin name	Description
3	Vss	Ground
4	VDD	Power input
1, 2, 5, 7, 8 & 9	PIN1,2,5,7,8 & 9	I/O, please refer to Pin mux table
6	ID	Connects to the Atmel ATSHA ID chip

5. Pin mux

In addition to acting as a GPIO, each pin on the imp001 can be configured to one of several specialized functions. While pins may only have one function at a time, they may be reconfigured during run-time to change function as needed. For example, a pin may first be configured as a DAC and then reconfigured as an ADC. Additionally, not all the pins in a hardware function need to be assigned to that function. For example, pins 8 and 9 could be used as UART and pins 1 and 2 could be used as I2C.

All I/O pins are initially tri-stated.

The imp001 can be woken from low power sleep mode with a rising edge on PIN1. If this signal is pulsed, the minimum pulse width is 20ms.

Pin	GPIO	UART	I2C	SPI	DAC	ADC	PWM	Pulse Count	Wake
PIN1	Yes	U1-CTS, U3-TX	I1-SCL	SPI1-SCLK	Yes	Yes	Yes	Yes	Yes
PIN2	Yes	U1-RTS, U3-RX	I1-SDA	SPI2-MISO		Yes	Yes		
PIN5	Yes	U2-TX		SPI2-SCLK	Yes	Yes	Yes		
PIN7	Yes	U2-RX		SPI2-MOSI		Yes	Yes		
PIN8	Yes	U1-TX	I2-SCL	SPI1-MOSI		Yes	Yes		
PIN9	Yes	U1-RX	I2-SDA	SPI1-MSO		Yes	Yes		

6. Electrical characteristics

Parameter	Condition	Min	Typ	Max	Unit.
Operating temperature		-20		55	°C
V _{DD}	Operating voltage	1.8 ^[1]	3.3	3.6	V
I _{DD}	Normal operation, WiFi on		80	400 ^[2]	mA
	Normal operation, WiFi power-save mode enabled		5	400 ^[2]	mA
	WiFi is off, processor sleep, RTC on, nvram preserved		6		µA
V _{IH}	I/O input high level voltage	0.7V _{DD}		3.6	V
V _{IL}	I/O input low level voltage	V _{SS} -0.3		0.3V _{DD}	V
I _{OUT}	Maximum current drive on I/O pins	-4		4	mA
I/O input leakage current	$V_{SS} \leq V_{IN} \leq V_{DD}$			4	µA
Load capacitance	Pins 1 to 9		20		pF

[1] WiFi requires 2.5v minimum for operation, but user code can run at 1.8v. The POWER_EN pin is driven to enable an external boost converter that will provide 2.5v+ during WiFi usage.

[2] 400mA current is during worst-case TX events. These are a maximum of ~4.8ms long (802.11b 1Mbps).

7. Typical Application Circuit

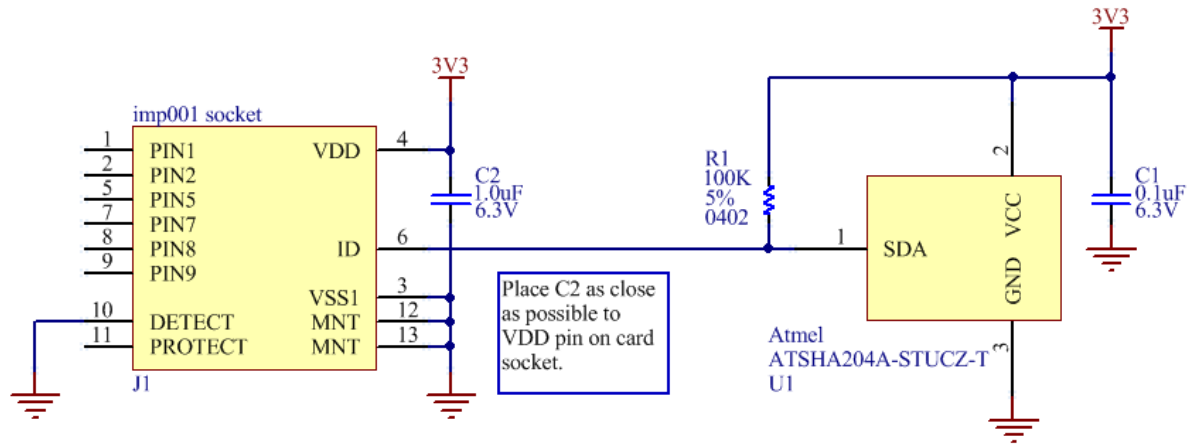

Notes:

1. U1 is an ATSHA204A unique ID IC. When the imp001 is installed, this unique ID is used to identify the host hardware within the Electric Imp service
2. Connecting the DETECT pin is not required, but typically improves layout and is therefore recommended.

8. Package outline

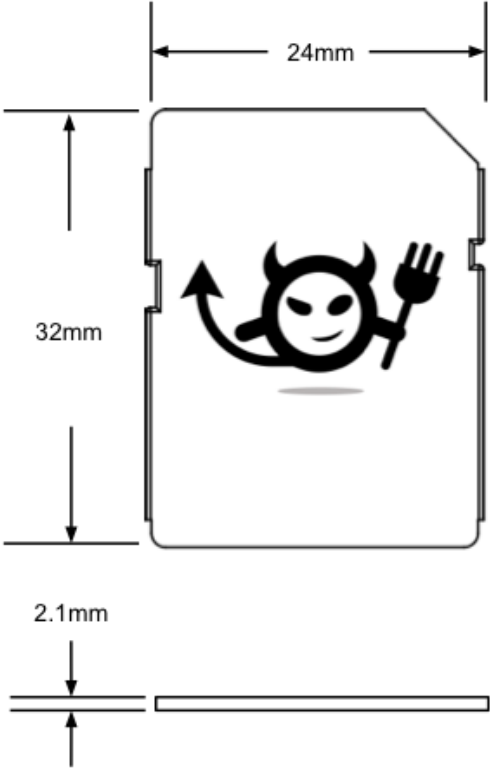

9. Recommended socket

Manufacturer = 4UCON

Part number = 19646

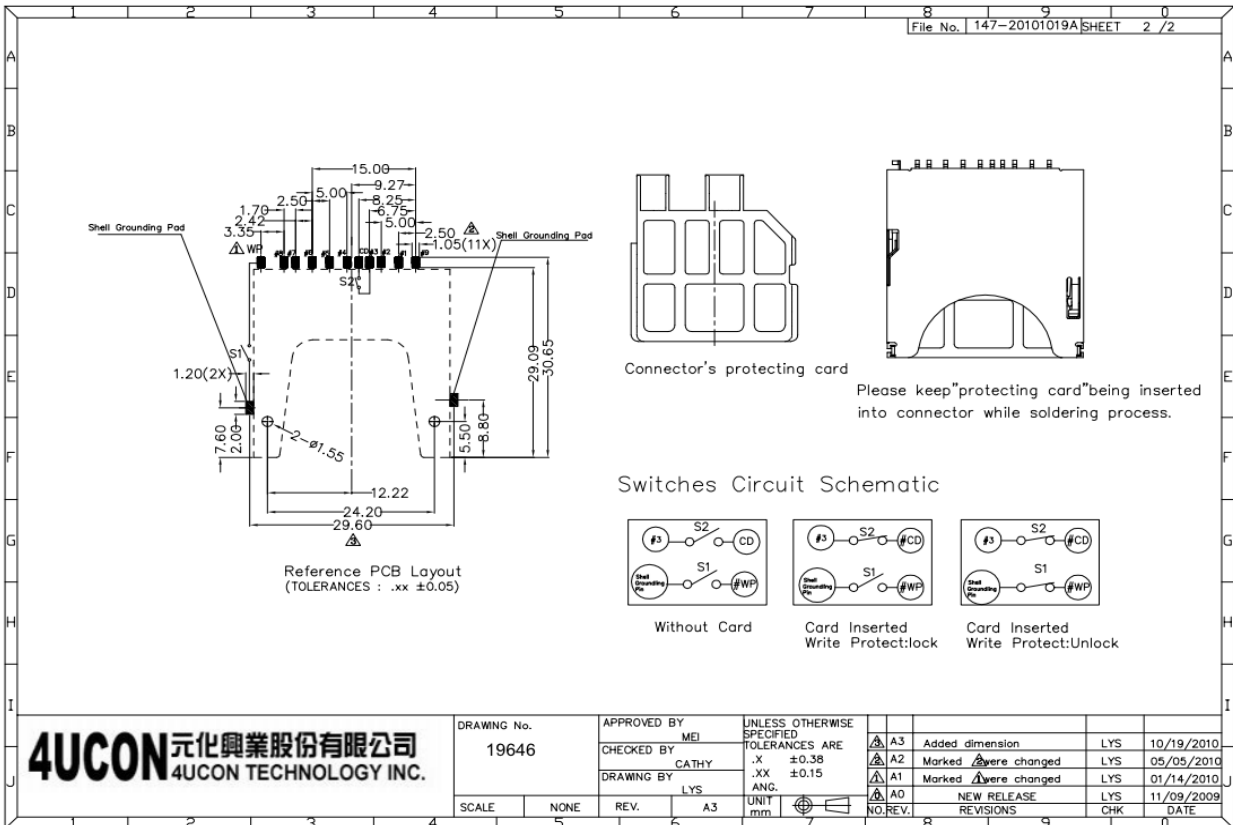

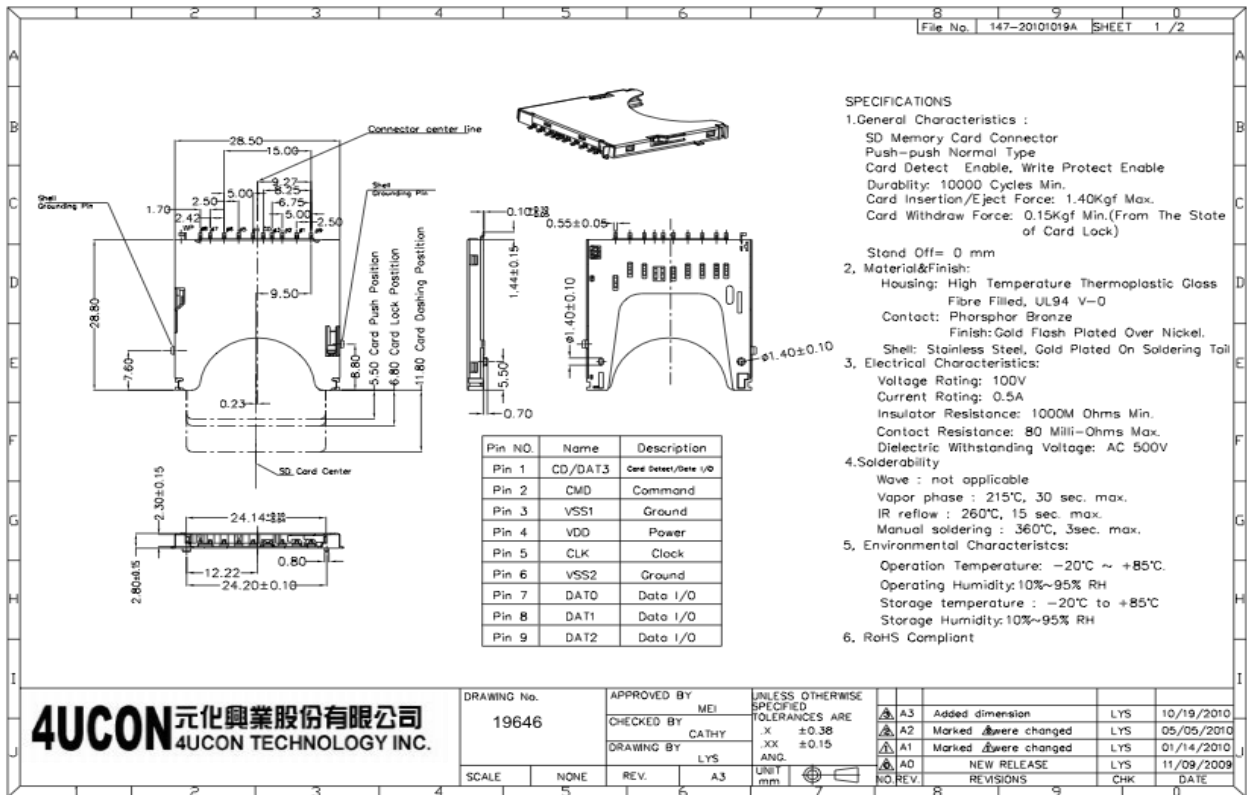

10. Layout recommendations

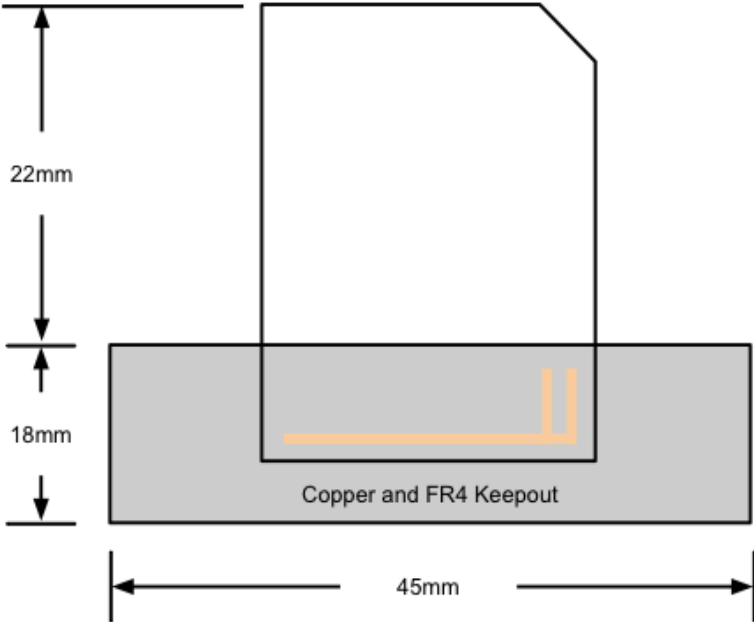

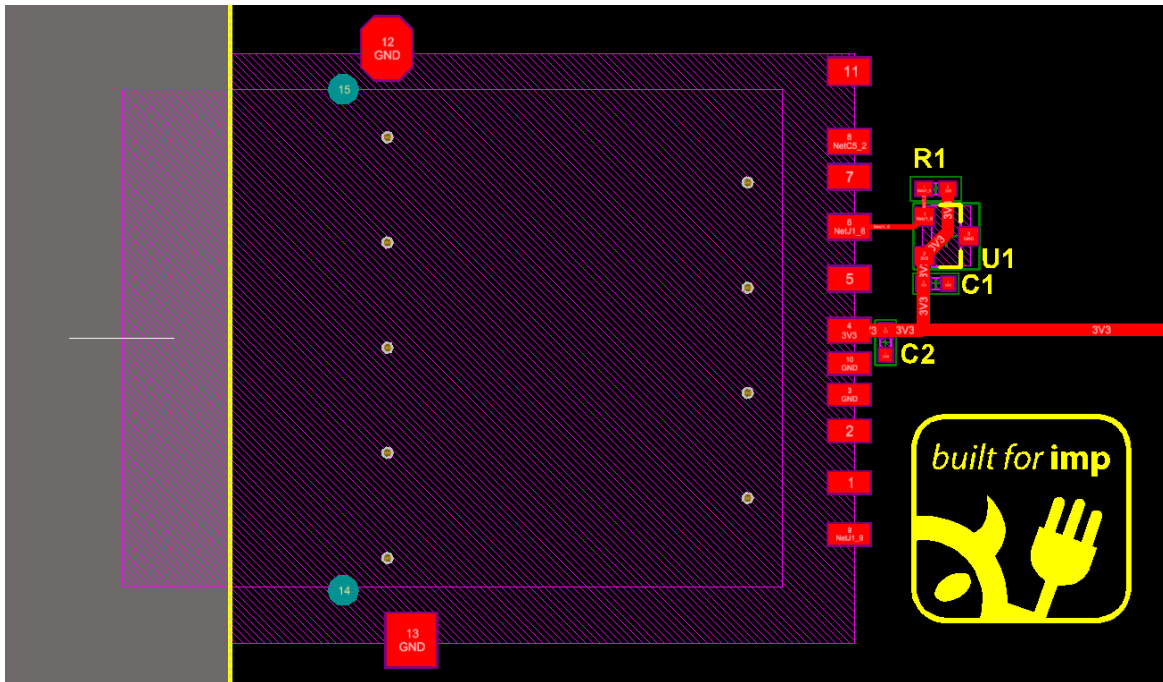

1: imp001 recommended layout with ground pours hidden

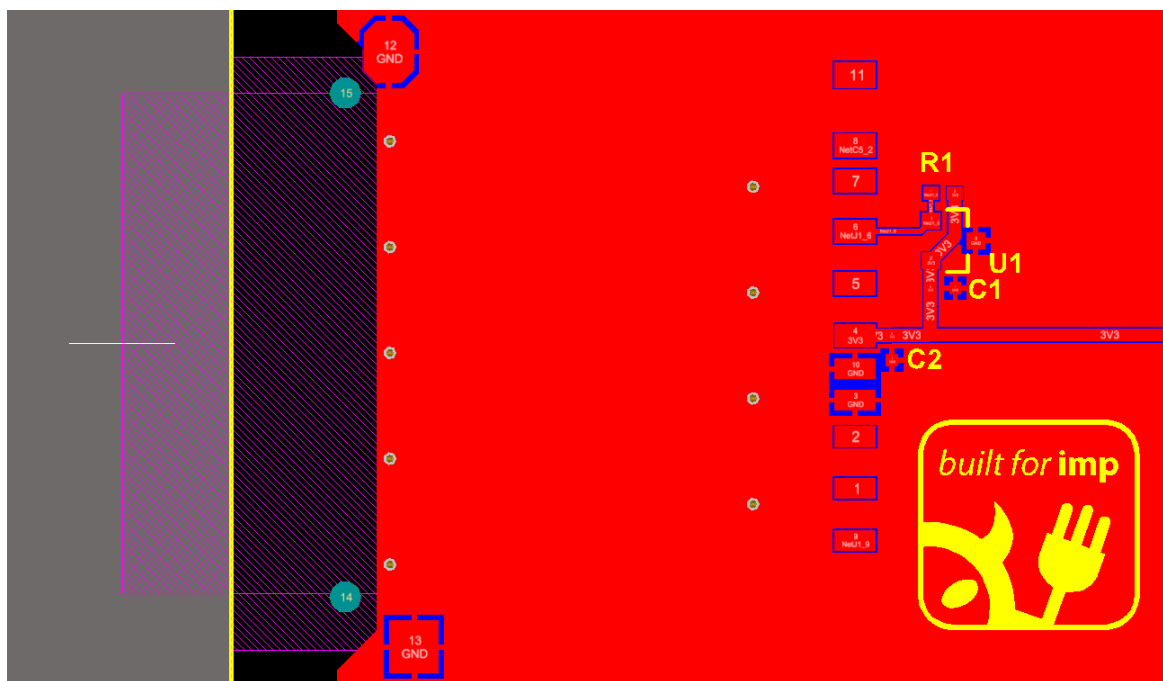

2: imp001 recommended layout with ground pours shown

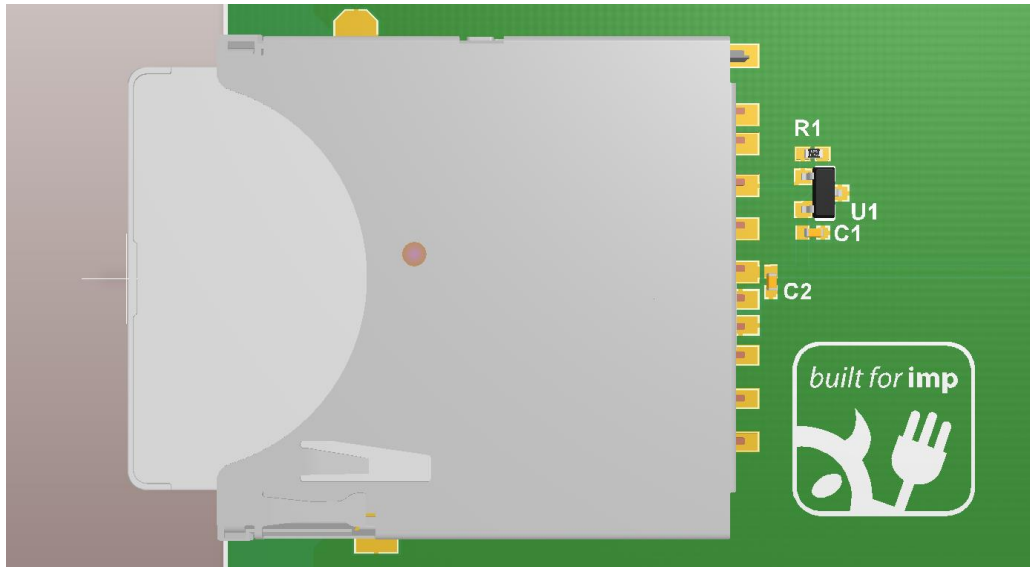

3: imp001 recommended layout in 3D, board top

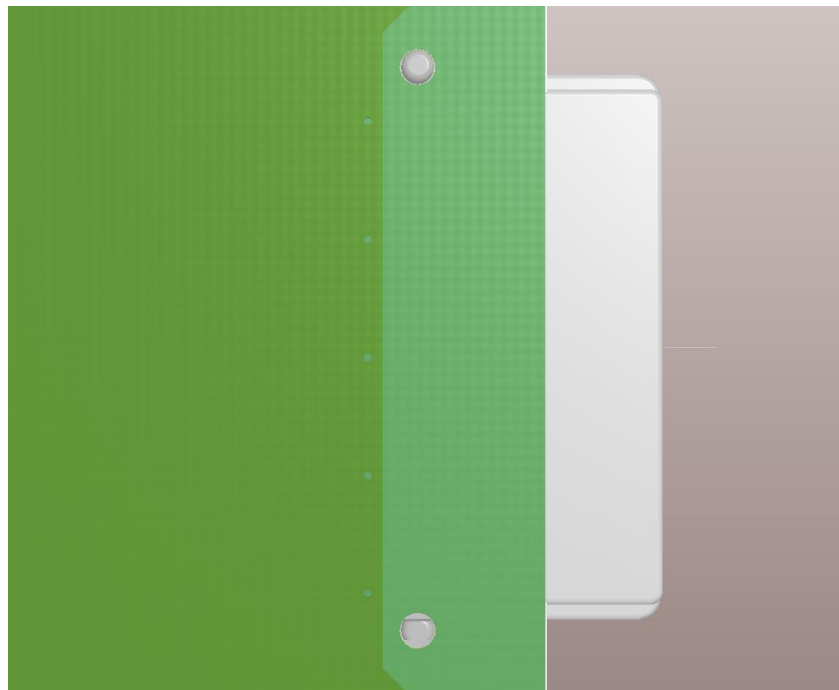

4: imp001 recommended layout in 3D, board bottom

Notes:

3. Do not place copper or board material in the antenna keepout area.
4. Ground planes must be poured on the top and bottom layer across the imp footprint, and stitched together with a row of vias between the mechanical pads on either side of the SD socket
5. Bypass capacitor should be placed as close as possible to the V_{DD} pin.

Version	Change description
20130419	added recommended layout
20130611	update electrical characteristics table
20131205	added ordering information, updated paragraph 2
20140225	Changed source format, updated branding.
20140226	Added application circuit and recommended layout
20140812	Changed ATSHA204 -> ATSHA204A (pin-compatible replacement)