

Dual IGBTMOD™ NF-Series Module 400 Amperes/600 Volts

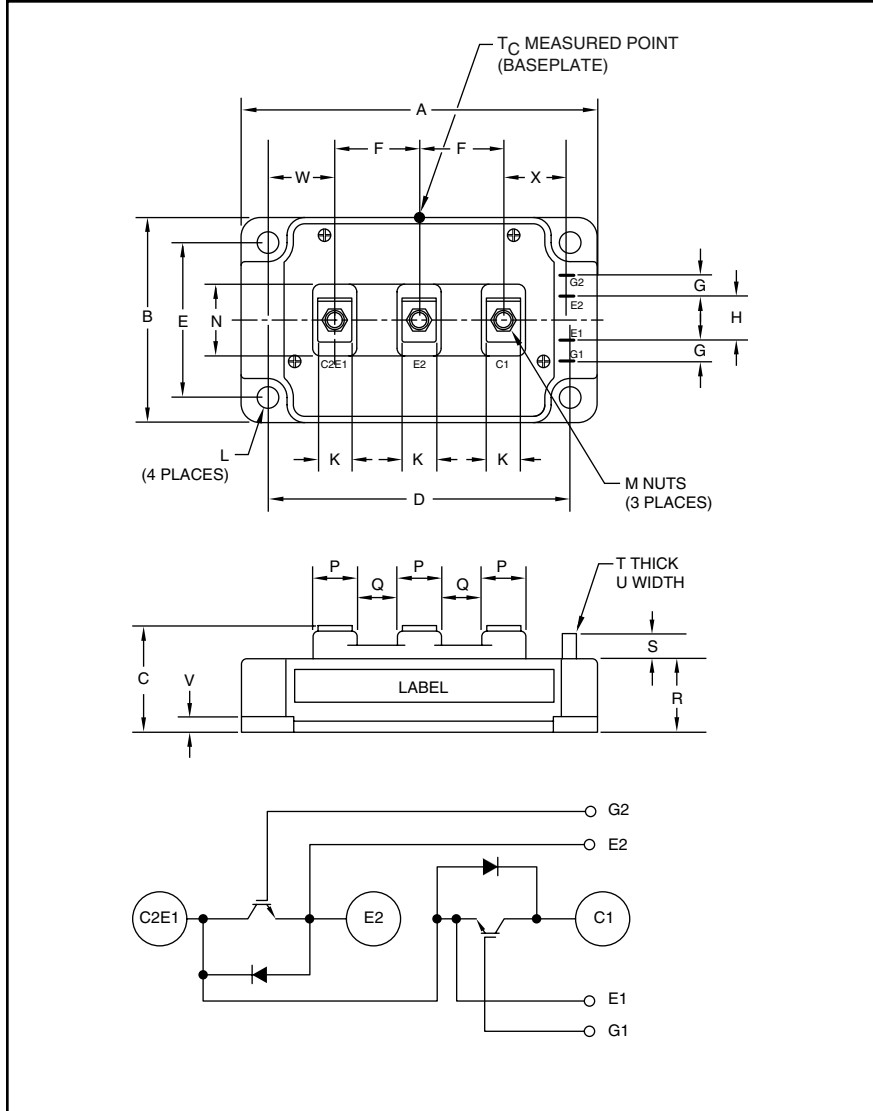

Outline Drawing and Circuit Diagram

Dimensions	Inches	Millimeters
A	4.25	108.0
B	2.44	62.0
C	1.18+0.04/-0.02	30.0+1.0/-0.5
D	3.66±0.01	93.0±0.25
E	1.89±0.01	48.0±0.25
F	0.98	25.0
G	0.24	6.0
H	0.59	15.0
K	0.55	14.0
L	0.26 Dia.	Dia. 6.5
M	M6 Metric	M6

Dimensions	Inches	Millimeters
N	1.18	30.0
P	0.71	18.0
Q	0.28	7.0
R	0.87	22.2
S	0.33	8.5
T	0.02	0.5
U	0.110	2.8
V	0.16	4.0
W	0.85	21.5
X	0.94	24.0

Description:

Powerex IGBTMOD™ Modules are designed for use in switching applications. Each module consists of two IGBT Transistors in a half-bridge configuration with each transistor having a reverse-connected super-fast recovery free-wheel diode. All components and interconnects are isolated from the heat sinking baseplate, offering simplified system assembly and thermal management.

Features:

- Low Drive Power
- Low $V_{CE(sat)}$
- Discrete Super-Fast Recovery Free-Wheel Diode
- Isolated Baseplate for Easy Heat Sinking

Applications:

- AC Motor Control
- UPS
- Battery Powered Supplies

Ordering Information:

Example: Select the complete part module number you desire from the table below -i.e. CM400DY-12NF is a 600V (V_{CES}), 400 Ampere Dual IGBTMOD™ Power Module.

Type	Current Rating Amperes	V_{CES} Volts (x 50)
CM	400	12



Powerex, Inc., 200 E. Hillis Street, Youngwood, Pennsylvania 15697-1800 (724) 925-7272

CM400DY-12NF
Dual IGBTMOD™ NF-Series Module
 400 Amperes/600 Volts

Absolute Maximum Ratings, $T_j = 25\text{ °C}$ unless otherwise specified

Ratings	Symbol	CM400DY-12NF	Units
Junction Temperature	T_j	-40 to 150	°C
Storage Temperature	T_{stg}	-40 to 125	°C
Collector-Emitter Voltage (G-E Short)	V_{CES}	600	Volts
Gate-Emitter Voltage (C-E Short)	V_{GES}	±20	Volts
Collector Current*** (DC, $T_C = 92\text{ °C}$)	I_C	400	Amperes
Peak Collector Current	I_{CM}	800*	Amperes
Emitter Current** ($T_C = 25\text{ °C}$)	I_E	400	Amperes
Peak Emitter Current**	I_{EM}	800*	Amperes
Maximum Collector Dissipation ($T_C = 25\text{ °C}$, $T_j \leq 150\text{ °C}$)	P_C	1130	Watts
Mounting Torque, M6 Main Terminal	—	40	in-lb
Mounting Torque, M6 Mounting	—	40	in-lb
Weight	—	400	Grams
Isolation Voltage (Main Terminal to Baseplate, AC 1 min.)	V_{ISO}	2500	Volts

Static Electrical Characteristics, $T_j = 25\text{ °C}$ unless otherwise specified

Characteristics	Symbol	Test Conditions	Min.	Typ.	Max.	Units
Collector-Cutoff Current	I_{CES}	$V_{CE} = V_{CES}$, $V_{GE} = 0V$	—	—	1.0	mA
Gate Leakage Current	I_{GES}	$V_{GE} = V_{GES}$, $V_{CE} = 0V$	—	—	0.5	µA
Gate-Emitter Threshold Voltage	$V_{GE(th)}$	$I_C = 40mA$, $V_{CE} = 10V$	5.0	6.0	7.5	Volts
Collector-Emitter Saturation Voltage	$V_{CE(sat)}$	$I_C = 400A$, $V_{GE} = 15V$, $T_j = 25\text{ °C}$	—	1.7	2.2	Volts
		$I_C = 400A$, $V_{GE} = 15V$, $T_j = 125\text{ °C}$	—	1.7	—	Volts
Total Gate Charge	Q_G	$V_{CC} = 300V$, $I_C = 400A$, $V_{GE} = 15V$	—	1600	—	nC
Emitter-Collector Voltage**	V_{EC}	$I_E = 400A$, $V_{GE} = 0V$	—	—	2.6	Volts

Dynamic Electrical Characteristics, $T_j = 25\text{ °C}$ unless otherwise specified

Characteristics	Symbol	Test Conditions	Min.	Typ.	Max.	Units
Input Capacitance	C_{ies}		—	—	60	nf
Output Capacitance	C_{oes}	$V_{CE} = 10V$, $V_{GE} = 0V$	—	—	7.3	nf
Reverse Transfer Capacitance	C_{res}		—	—	2.4	nf
Inductive Load	Turn-on Delay Time	$V_{CC} = 300V$, $I_C = 400A$, $V_{GE1} = V_{GE2} = 15V$, $R_G = 3.1\Omega$,	—	—	300	ns
	Rise Time					
Switch Time	Turn-off Delay Time	Inductive Load	—	—	450	ns
	Fall Time					
Diode Reverse Recovery Time**	t_{rr}	Switching Operation,	—	—	250	ns
Diode Reverse Recovery Charge**	Q_{rr}	$I_E = 400A$	—	6.8	—	µC

*Pulse width and repetition rate should be such that device junction temperature (T_j) does not exceed $T_{j(max)}$ rating.

**Represents characteristics of the anti-parallel, emitter-to-collector free-wheel diode (FWDi)

*** T_c measured point is just under the chips. If this value is used, $R_{th(f-a)}$ should be measured just under the chips.



Powerex, Inc., 200 E. Hillis Street, Youngwood, Pennsylvania 15697-1800 (724) 925-7272

CM400DY-12NF
Dual IGBTMOD™ NF-Series Module
 400 Amperes/600 Volts

Thermal and Mechanical Characteristics, $T_j = 25^\circ\text{C}$ unless otherwise specified

Characteristics	Symbol	Test Conditions	Min.	Typ.	Max.	Units
Thermal Resistance, Junction to Case	$R_{th(j-c)Q}$	Per IGBT 1/2 Module, T_C Reference Point per Outline Drawing	—	—	0.11	$^\circ\text{C/W}$
Thermal Resistance, Junction to Case	$R_{th(j-c)D}$	Per FWDi 1/2 Module, T_C Reference Point per Outline Drawing	—	—	0.19	$^\circ\text{C/W}$
Thermal Resistance, Junction to Case	$R_{th(j-c)'Q}$	Per IGBT 1/2 Module, T_C Reference Point Under Chips	—	—	0.066	$^\circ\text{C/W}$
Contact Thermal Resistance	$R_{th(c-f)}$	Per 1/2 Module, Thermal Grease Applied	—	0.04	—	$^\circ\text{C/W}$
External Gate Resistance	R_G		1.6	—	16	Ω

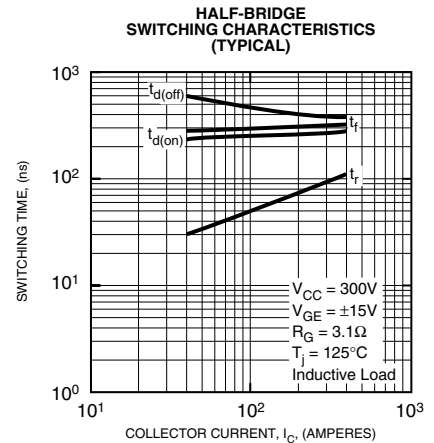
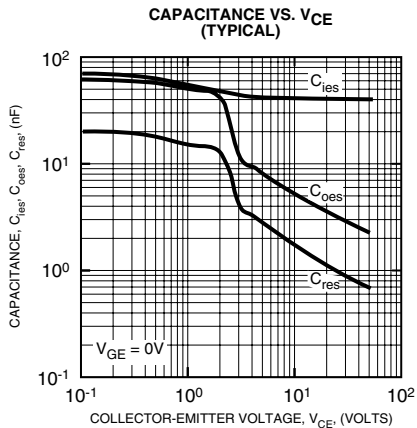
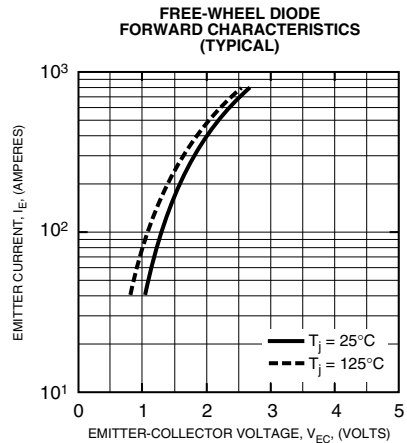
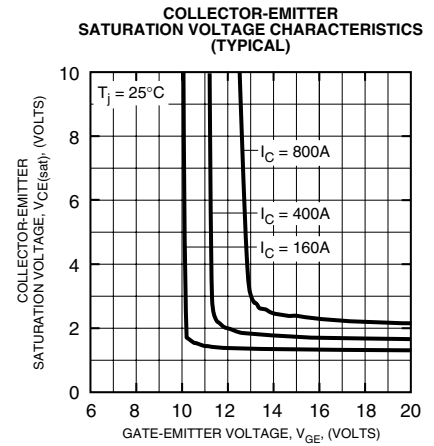
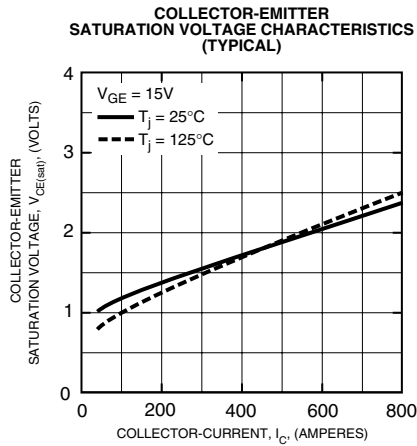
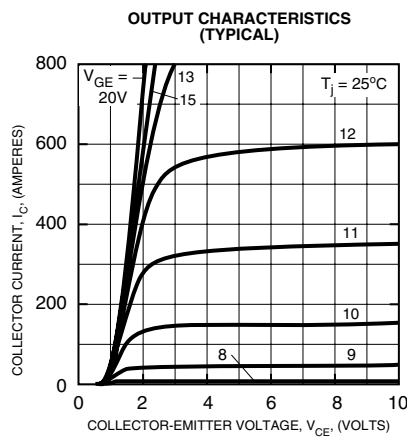



Powerex, Inc., 200 E. Hillis Street, Youngwood, Pennsylvania 15697-1800 (724) 925-7272

CM400DY-12NF
Dual IGBTMOD™ NF-Series Module
 400 Amperes/600 Volts

