

Digital Temperature Controllers

E5□C Series

The Leading Temperature Controllers in the Control Panel Evolution



- Greater downsizing and higher performance in control panels and other equipment
- Greater efficiency from designing to assembly and operation
- Innovating control panel and equipment usability

New Value For Control Panels

Control Panels: The Heart of Manufacturing Sites.

Evolution in control panels results in large evolution in production facilities.

And if control panel design, control panel manufacturing processes, and human interaction with them are innovated, control panel manufacturing becomes simpler and takes a leap forward.

OMRON will continue to achieve a control panel evolution and process innovation through many undertakings starting with the shared Value Design for Panel *1 concept for the specifications of products used in control panels.

*1 Value Design for Panel



Our shared Value Design for Panel (herein after referred to as "Value Design") concept for the specifications of products used in control panels will create new value to our customer's control panels.

Combining multiple products that share the Value Design concept will further increase the value provided to control panels.

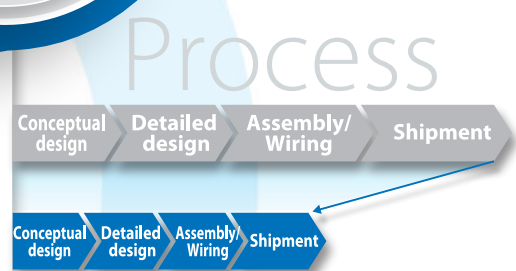

Panels



People



The Leading Temperature Controllers in the Control Panel Evolution



Greater downsizing and higher performance in control panels and other equipment

- A wide range of lineup to handle various control panel/equipment sizes.
- Advanced control performance to help increase equipment speed and yield.

Greater efficiency from designing to assembly and operations

- Saves your work in each process from designing to operation of control panels and other equipment.

Innovating control panel and equipment usability

- Wide viewing angle and high-contrast LCD for high visibility.
- Reduces the workload of entering set values on-site.

Certified for main safety standards.



(E5□C/-U)

(E5CC-B,
E5EC-B)

*CSA conformance evaluation by UL.

A wide range of lineup to handle various control panel/equipment sizes

Save Space with a Compact Body That's Only 60 mm in Depth

A short body that's 77% of our previous model has been achieved. This makes the Controller applicable in tight spaces with limited depth.



E5CC
E5EC
E5AC

*In comparison with the E5CN.

Help Reduce Panel Space

Even with the 48 × 24 size, OMRON has achieved a PV display character height of over 10 mm and dual displays for the present value and set point. This enables compact panels that are easy to read.



E5GC

Equal Operability as On-panel Controllers Plus Space-saving Layouts inside Control Panels

The unified operability of the E5□C Series in a DIN Track-mounting Controller that is 22.5 mm wide. You can achieve space-saving layouts in control panels.



E5DC

Push-In Plus Terminal Blocks Enables Horizontal Group Mounting Easily

With Push-In Plus terminal blocks, wiring is performed from the back, which facilitates using horizontal group mounting, to achieve compact panel surfaces.



E5CC-B
E5EC-B

Advanced control performance to help increase equipment speed and yield

High-speed Control to Maximize Equipment Performance

Performing autotuning (robust tuning) once achieves high-speed control to reach 350°C in approx. 3 seconds.* You get stable control without overshooting.



Application Example
Flip Chip Bonder

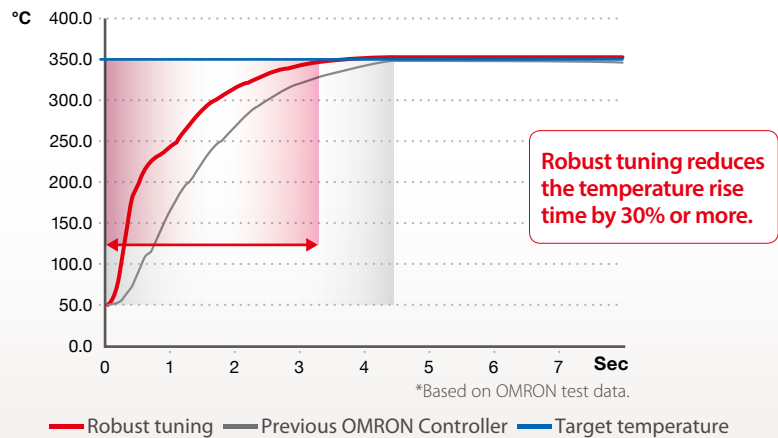

Robust tuning (RT) : Used with heaters whose temperature increases quickly to automatically set the optimum PID constants.

Stable Control to Help Increase Yield

Stable control is achieved even for hard-to-control water-cooled extruders with tuning for water cooling. Stable control also means that you'll save energy.



Application Example
Water-cooled Extruder

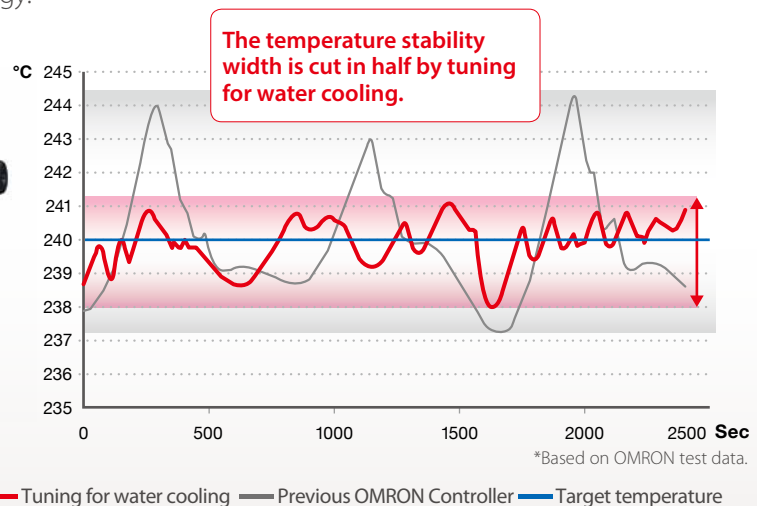

Tuning for water cooling : Uses a tuning algorithm designed for water cooling, which is different from normal cooling methods, to automatically set the optimum PID constants for water cooling.

Greater efficiency from designing to assembly and operation

Design

Programless Communications Eliminates the Time to Create Communications Program with the PLC.

- In addition to communications with PLCs, you can share target temperatures and copy parameter settings with other E5□C series Controllers.

Assembly and Wiring

Push-In Plus Terminal Blocks for Easy Wiring

Just Insert Wires: No Tools Required
Now you can use Push-In Plus terminal blocks to reduce the time and work involved in wiring.

Greatly Reduce Wiring Work with Push-In Plus Terminal Blocks

Easy to Insert
OMRON's Push-In Plus terminal blocks are as easy as inserting to an earphone jack. They help reduce the work load and improve wiring quality.

Held Firmly in Place
Even though less insertion force is required, the wires are held firmly in place. The advanced mechanism design technology and manufacturing technology produced a spring that ensures better workability and reliability.

IEC standard (cable diameter)	Push-In Plus terminal block	Screw terminal block
20 N min. (AWG20,0.5 mm ²)	125 N	112 N

No Retightening Required
Tightening screws is necessary for screw terminal blocks, but with Push-In Plus terminal blocks, there is no need for retightening.

Temperature Sensors
Temperature Sensors with Ferrules are also available to help reduce the time and work involved in wiring.

**E5CC-B
E5EC-B**

Setup, Adjustment, and Operation

CX-Thermo Special Setup Software (Sold Separately) Effectively Reduces Work from Setup to Adjustment and Operation.

You can perform the following operations with the CX-Thermo.

- Setting and saving parameters
- Logging, browsing, and exporting data
- Printing parameter lists, and more

Also, power is supplied through the Bus Power, so you do not have to wire the power supply to set parameters.

*USB-Serial Conversion Cable (Sold Separately)

Innovating control panel and equipment usability

Easy Display Confirmation On-site.

Big white characters on a black background achieve superior visibility. Operator movement distances are minimized to help increase work efficiency.

Life Size



High-contrast displays enable easier confirmation regardless of ambient lighting conditions.



A wide viewing angle was achieved with the LCDs to enable easy confirmation of the PV.

Reduces the workload of entering set values on-site.

Functions are provided to reduce work in operating and changing settings for the Controllers.

Just press the shift key (<<PF) to move the digit. This simplifies numeric entry at worksite.



Just press the shift key to move the digit.







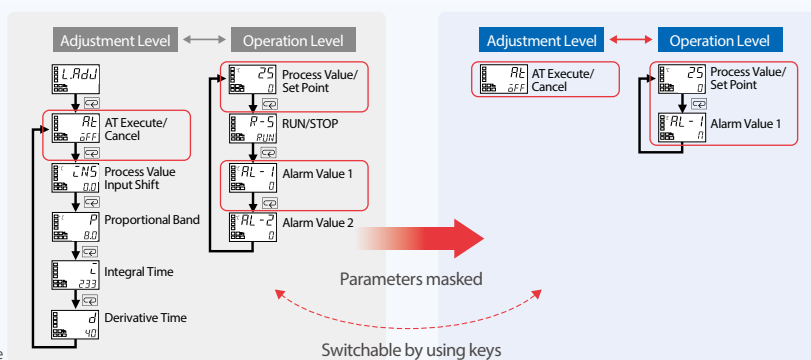



CX-Thermo Functions

Use parameter masks to display only the required parameters. The time required to change settings, such as for changeovers, is greatly reduced.

Items to manipulate



Product Lineup

Size	48 × 24 mm	48 × 48 mm			48 × 96 mm		96 × 96 mm	DIN 22.5-mm width
Model	E5GC	E5CC	E5CC-B	E5CC-U	E5EC	E5EC-B	E5AC	E5DC
Terminal type	Screw terminal block Screw-less clamp terminal block	Screw terminal block	Push-In Plus terminal block	Plug-in models	Screw terminal block	Push-In Plus terminal block	Screw terminal block	Screw terminal block
Appearance			 			 		

Refer to the E5□C Series Datasheet (Cat. No. H177) for details.

Products That Create New Value in Control Panels





Switch Mode Power Supplies
S8VK-S



Uninterruptible Power Supply (UPS)
S8BA



Power Monitors
KM-N2/KM-N3



Measuring and Monitoring Relays
K8DT



Solid-state Timers
H3DT



Solid-state Timers
H3Y(N)-B



Solid-state Timers
H3RN-B



Liquid Leakage Sensor Amplifiers
K7L-B



Sockets for Relays with Forcibly Guided Contacts (for G7SA)
P7SA-PU



Common Sockets (for MY/H3Y(N)-B)
PYF-PU(L)



Common Sockets (for G2R-S/H3RN-B/K7L-B)
P2RF-PU



Slim I/O Relays
G2RV-SR



Slim I/O Relays
G3RV-SR



I/O Relay Terminals
G70V



Pushbutton Switches Push-In Plus Terminal Block Series
A22N-P/A30N-P/M22N-P



Solid State Relays for Heaters
G3PJ



DIN Track Terminal Block
XW5T



Digital Temperature Controllers
E5CC-B/E5EC-B

Panel Assist Web

www.ia.omron.com/solution/panel/





Innovation in Control Panel Building
Cat. No. Y218

Before you place an order, please read and understand "Agreement for Using the Product" available on Omron's latest "Best control devices Omron," "General Brochure" or Omron's website.

OMRON Corporation Industrial Automation Company
Kyoto, JAPAN

Contact: www.ia.omron.com

Regional Headquarters

OMRON EUROPE B.V.
Wegalaan 67-69, 2132 JD Hoofddorp
The Netherlands
Tel: (31)2356-81-300/Fax: (31)2356-81-388

OMRON ASIA PACIFIC PTE. LTD.

No. 438A Alexandra Road # 05-05/08 (Lobby 2),
Alexandra Technopark,
Singapore 119967
Tel: (65) 6835-3011/Fax: (65) 6835-2711

OMRON ELECTRONICS LLC

2895 Greenspoint Parkway, Suite 200
Hoffman Estates, IL 60169 U.S.A.
Tel: (1) 847-843-7900/Fax: (1) 847-843-7787

OMRON (CHINA) CO., LTD.

Room 2211, Bank of China Tower,
200 Yin Cheng Zhong Road,
PuDong New Area, Shanghai, 200120, China
Tel: (86) 21-5037-2222/Fax: (86) 21-5037-2200

Authorized Distributor:

© OMRON Corporation 2016 All Rights Reserved.
In the interest of product improvement,
specifications are subject to change without notice.

CSM_1_2_0916
Cat. No. H220-E1-01

0316 (0316)