

AP17E.07.0064A

Specification

Part No.	AP17E.07.0064A
Product Name	17mm One Stage GPS Active Patch Antenna Module with Front End SAW Filter
Feature	17mm*17mm*6.3mm 64mm 1.13 IPEX MHFI Wide Voltage 1.8V~5.5V 15dB LNA Tested in Free space RoHS Compliant

1. Introduction

The AP.17E is a one stage 17mm active patch antenna that has been designed specifically for embedded (inside device) integration with GPS receiver modules.

The AP.17E combines a 17*17*4mm advanced low profile ceramic patch antenna with a one stage LNA and a front-end SAW filter with ultra thin coaxial cable. It comes with it's own integrated ground-plane.

The front end SAW filter reduces the risks where there is a cellular transmitter nearby of interference from out of band frequencies which can cause LNA burn-out, saturation, or radiated spurious emissions.

The antenna can work on a wide input voltage from 1.8V to 5.5V with best in class power consumption figures.

If further tuning and optimization specific to a customer device is required Taoglas offers a custom tuned and optimized part service. Contact sales@taoglas.com for more information.

Cables and connectors can be customized according to request.

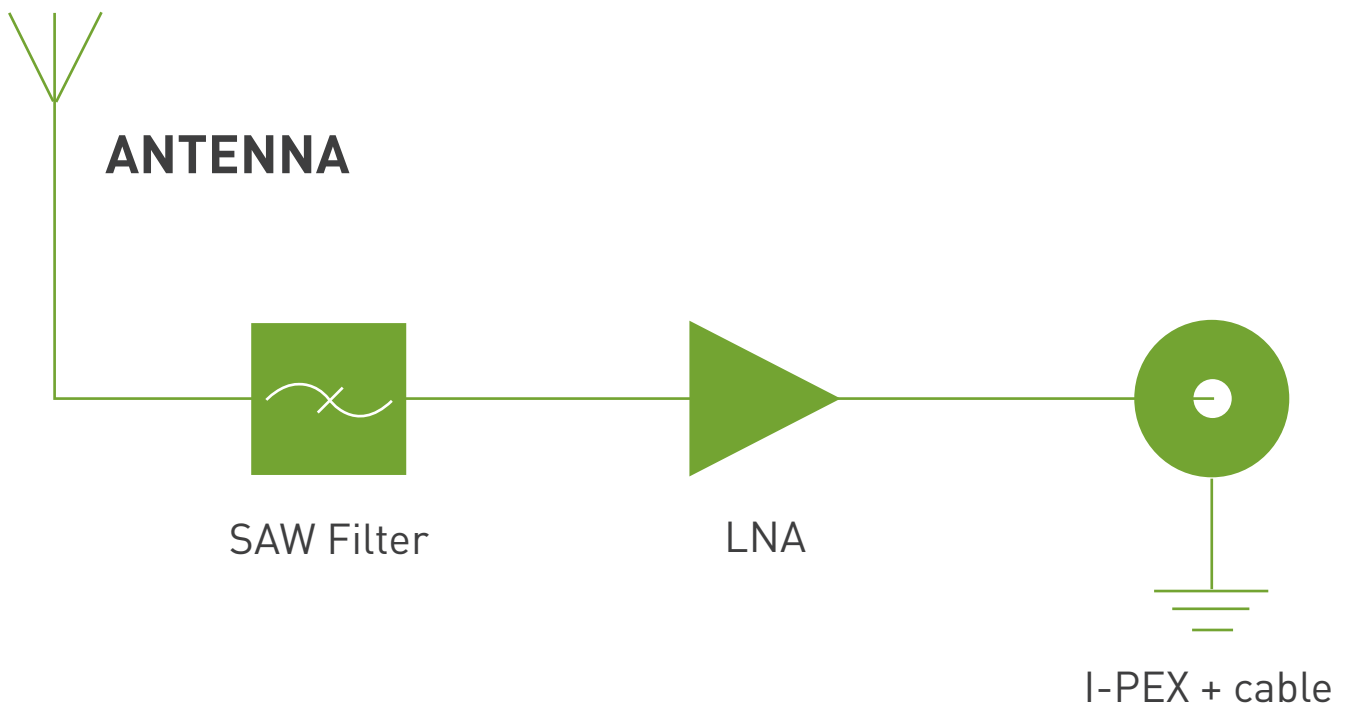

2. Specification

2.1 Patch Antenna

Parameter	Specification
Frequency	1575.42 ± 1.023MHz
Gain @ Zenith	-1.0dBic Typ. @ Zenith
Polarization	RHCP
Axial Ratio	3.0dB max @ Zenith
Patch Dimension	17*17*4mm

2.2 LNA

Parameter	Specification
Frequency	1575.42 ± 1.023MHz
Outer Band Attenuation	F0=1575.42MHz F0±30MHz 2dB min. F0±50MHz 18dB min. F0±100MHz 25dB min.
Output Impedance	50Ω
Output VSWR	2.0 Max
Pout at 1dB Gain	Typ. -2dBm
Compression point	Min. -6dBm

LNA Gain, Power Consumption and Noise Figure

Voltage	LNA Gain (Typ)	Power Consumption(mA) Typ	Noise Figure Typ
Min. 1.8V	13dB	1.6mA	2.5dB
Typ. 3.0V	16dB	3.5mA	2.5dB
Max. 5.5V	17dB	7.6mA	2.6dB

2.3 Cable* & Connector

Parameter	Specification
RF Cable	Coaxial Cable Ø 1.13 ± 0.1mm, length 64mm ± 2.5mm
Connector	IPEX MHFI (U.FL)

3. LNA Gain and Out Band Rejection @3.0V



Cg1	Tr1	S21	>1	1.5754200 GHz	16.111 dB
Cg1	Tr1	S21	2	1.6054200 GHz	-27.059 dB
Cg1	Tr1	S21	3	1.5454200 GHz	12.455 dB
Cg1	Tr1	S21	4	1.6254200 GHz	-34.597 dB
Cg1	Tr1	S21	5	1.5254200 GH	-3.4458 dB
Cg1	Tr1	S21	6	1.6754200 GHz	-20.195 dB
Cg1	Tr1	S21	7	1.4754200 GHz	-10.158 dB

4. LNA Noise Figure @3.0V

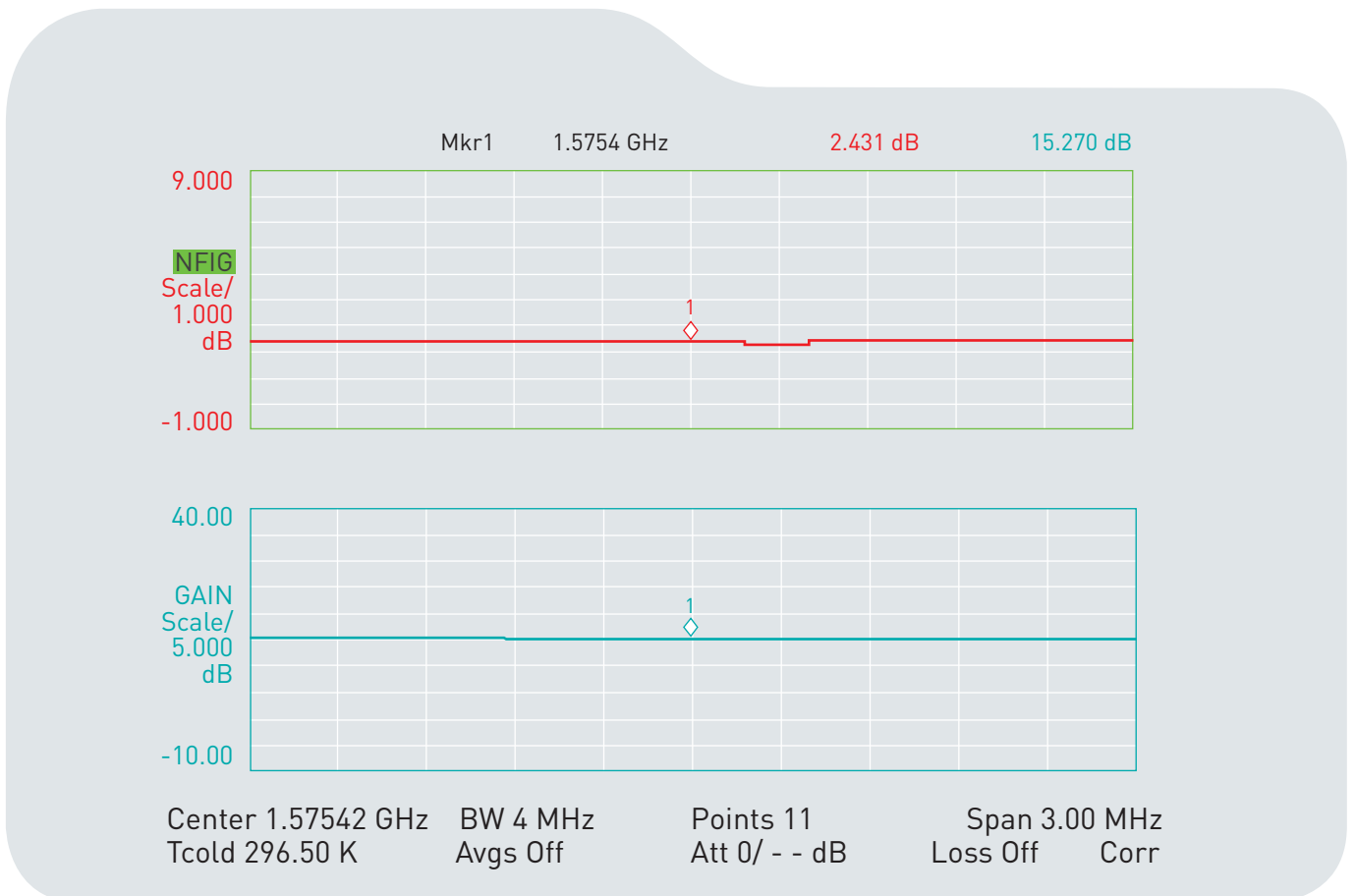



5. Total Specification (through Antenna, LNA, Cable and Connector)

Parameter	Specification
Frequency	1575.42 ± 1.023MHz
Gain	At 3V: 15 ± 3dBic @ 90°
Output Impedance	50Ω
Polarization	RHCP
Output VSWR	Max 2.0
Operation Temperature	-40°C to + 85°C
Storage Temperature	-40°C to + 85°C
Relative Humidity	40% to 95%
Input Voltage	Min. 1.8V, Typ. 3.0V, Max. 5.5V
Antenna	17*17*6.1mm

6. Radiation Patterns

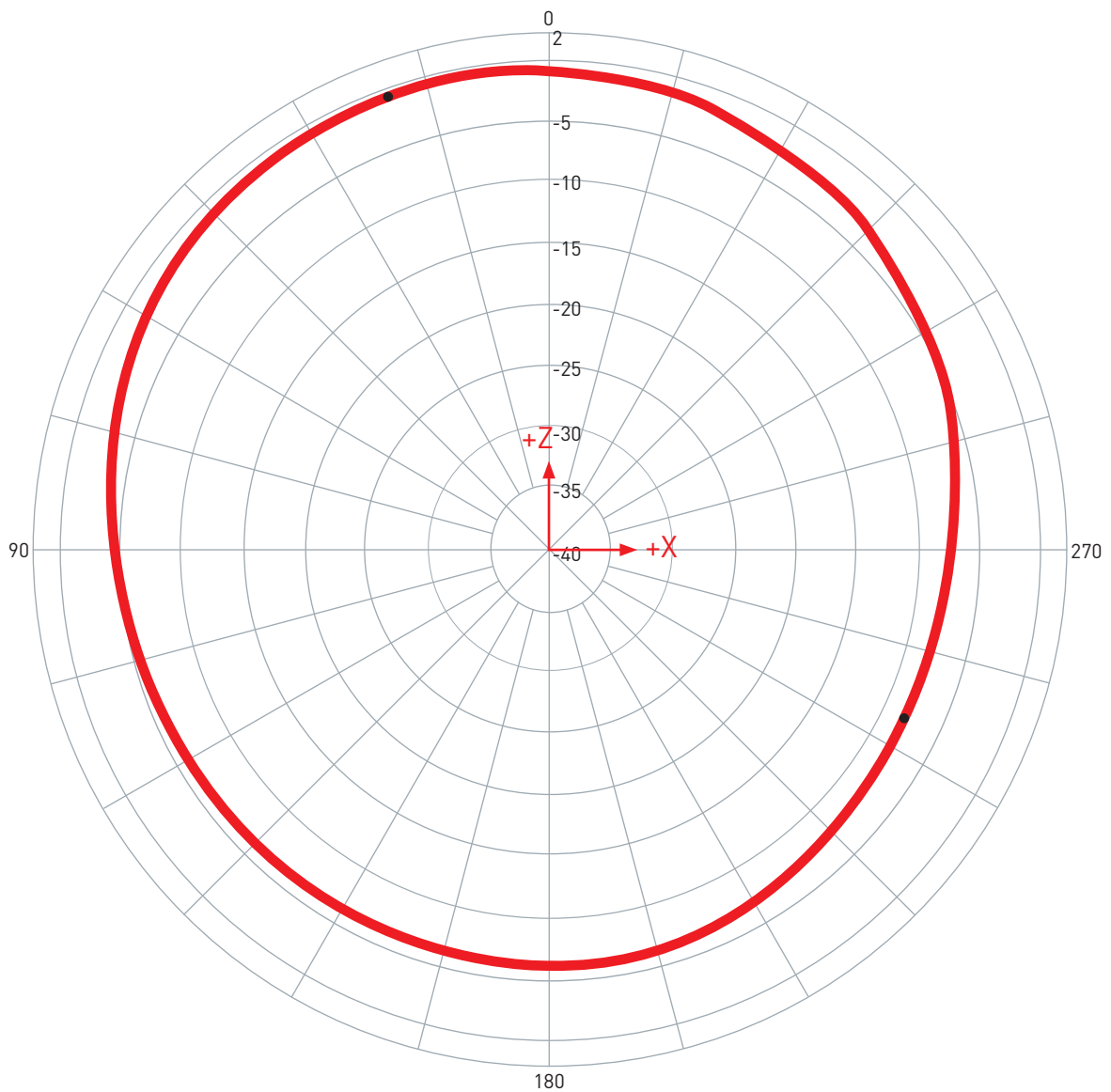
6.1 XZ Plane Radiation



Pattern	Model No.	Test Mode	Freq (MHz)	Max Gain(dBi)	Min Gain(dBi)	Avg. Gain(dBi)	Source Polar.	Date
1 	AP17E.07.0064A	XZ	1575.42	-0.88 / 20.00	-8.25 / 244.00	-4.01	RHCP	2011/9/9

6.2 YZ Plane Radiation

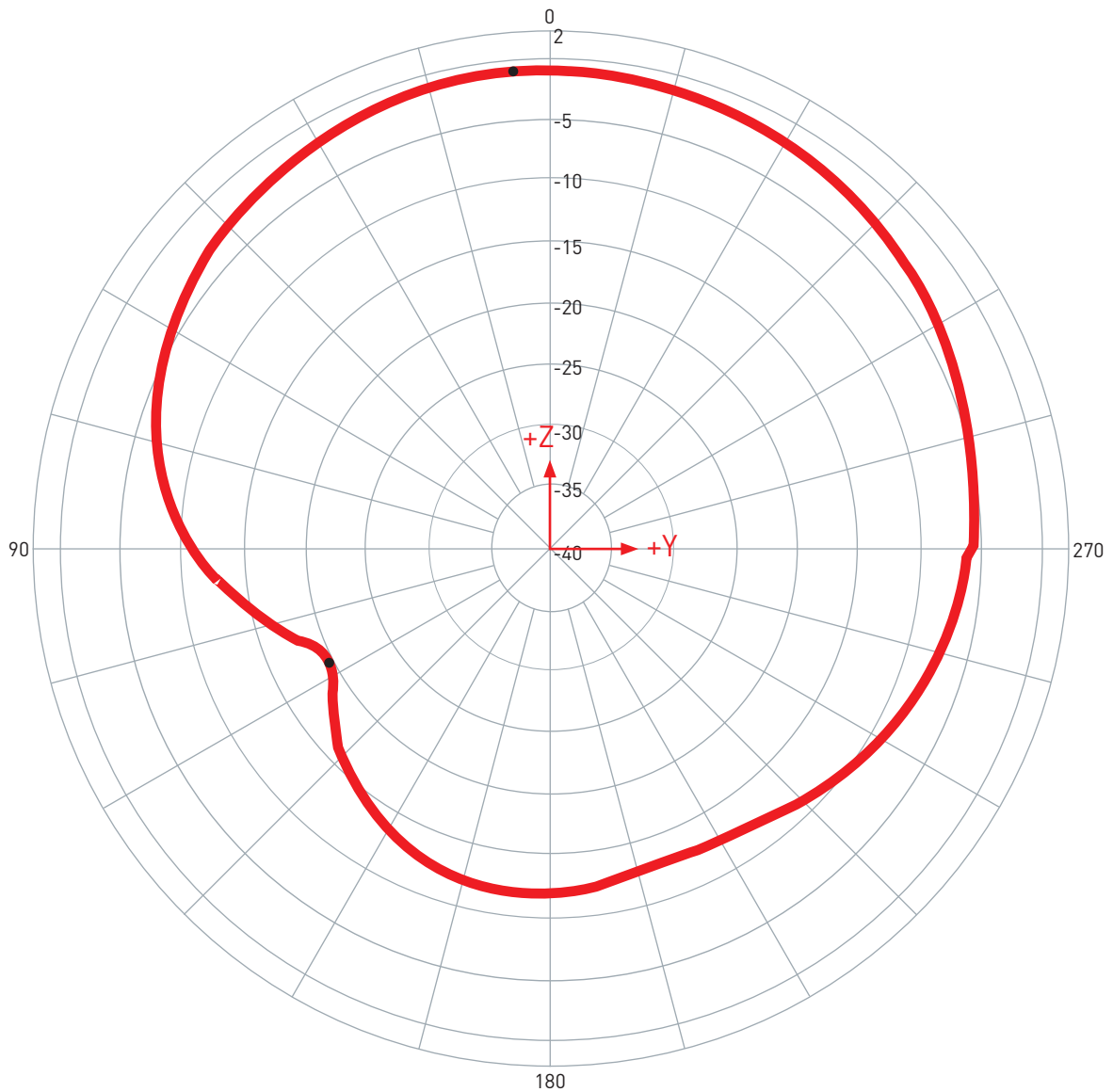

Pattern	Model No.	Test Mode	Freq (MHz)	Max Gain(dBi)	Min Gain(dBi)	Avg. Gain(dBi)	Source Polar.	Date
1	AP17E.07.0064A	YZ	1575.42	-1.01 / 4.00	-19.77 / 118.00	-5.35	RHCP	2011/9/9

6.3 XY Plane Radiation

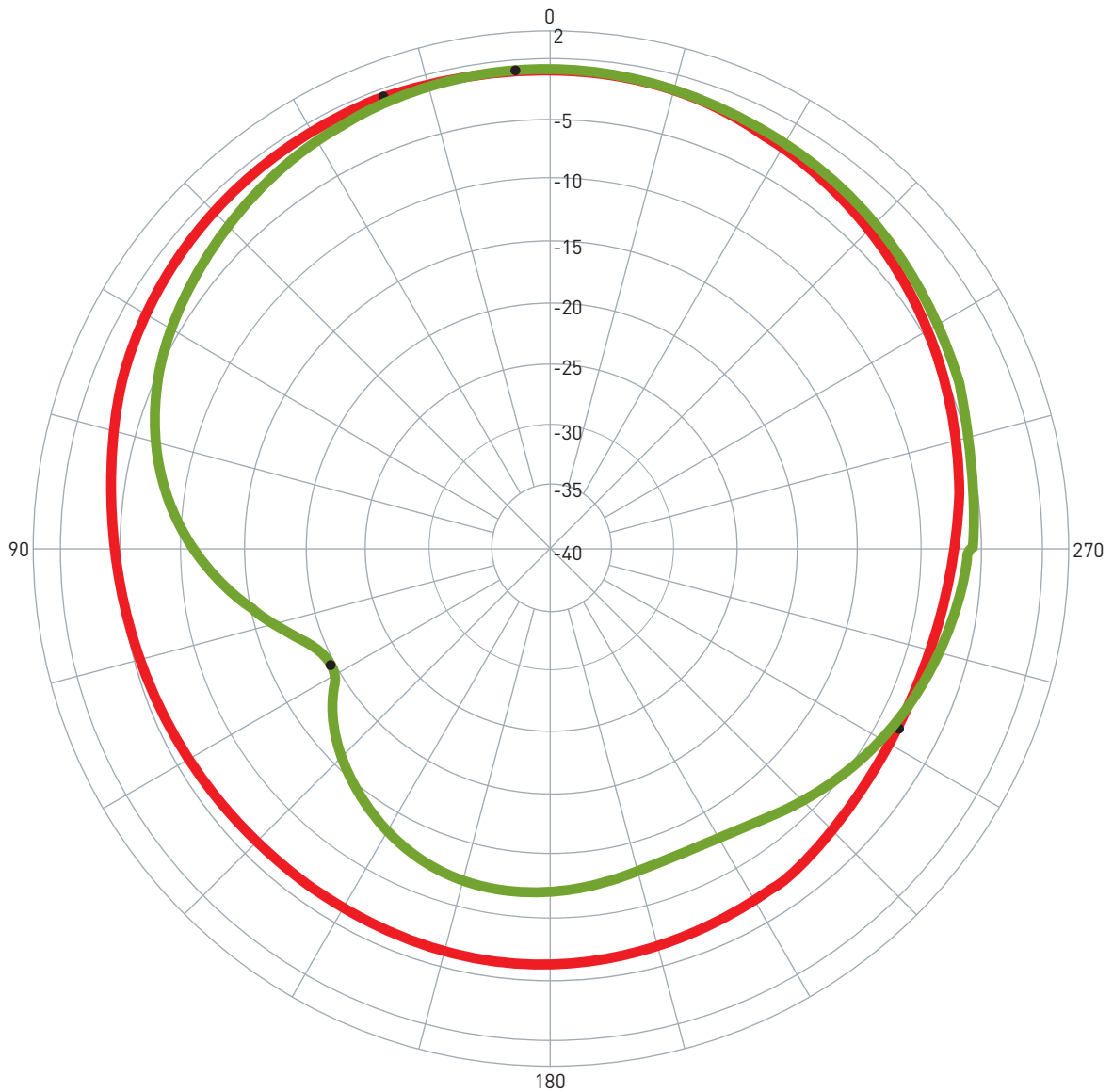

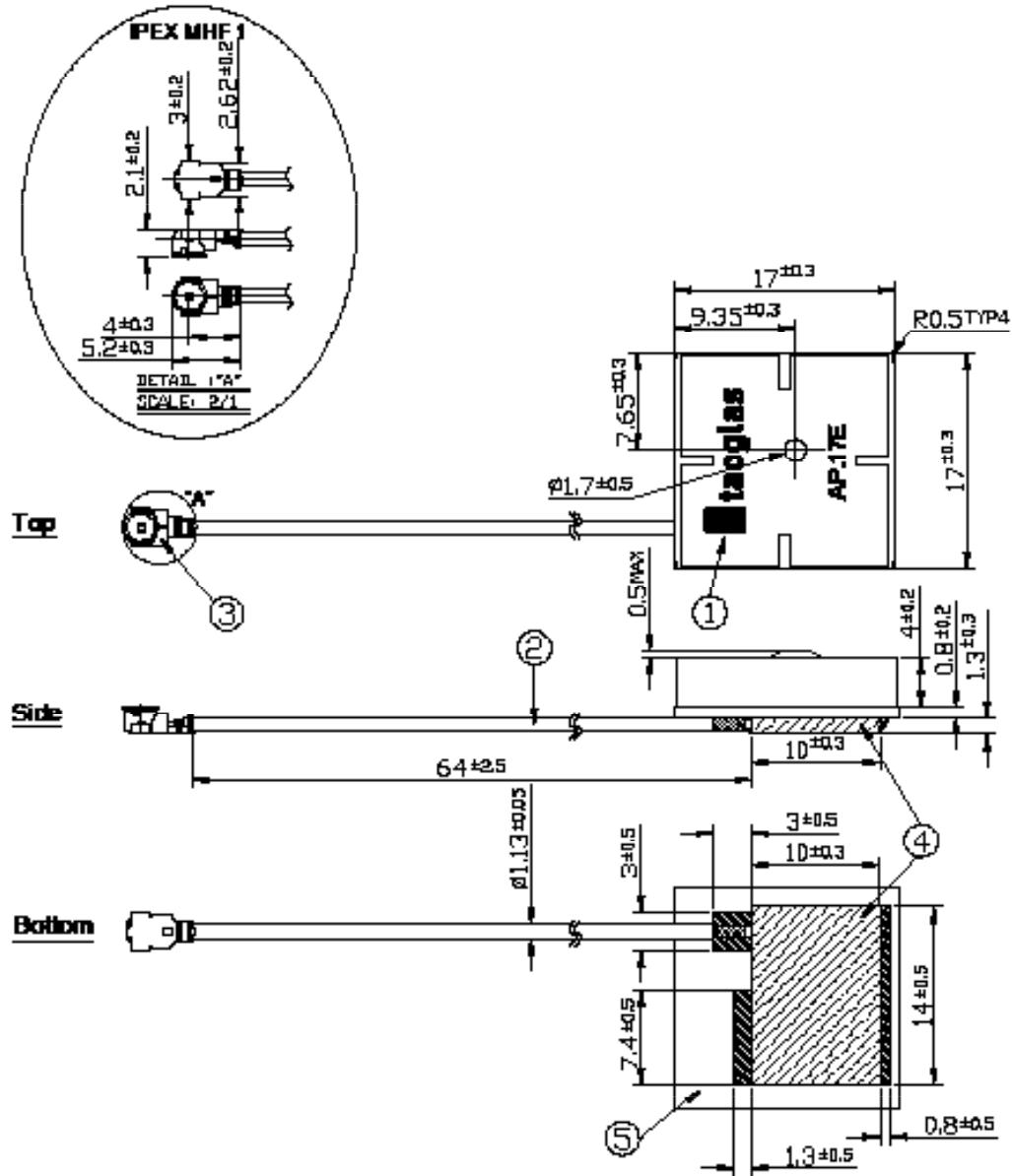

Pattern	Model No.	Test Mode	Freq (MHz)	Max Gain(dBi)	Min Gain(dBi)	Avg. Gain(dBi)	Source Polar.	Date
1	AP17E.07.0064A	XZ	1575.42	-0.88 / 20.00	-8.25 / 244.00	-4.01	RHCP	2011/9/9
2	AP17E.07.0064A	YZ	1575.42	-1.01 / 4.00	-19.77 / 118.00	-5.35	RHCP	2011/9/9

7. Technical Drawing



NOTE:

1. Soldered area 
2. Shielding case 
3. The connector position has special orientation to the PCB as per drawing.
4. All material must be RoHS compliant.
5. Open/short QC, VSWR required.

	Name	P/N	Material	Finish	QTY
1	AP.17E Patch (17*17*4mm)	AP.17E	Ceramic	Clear	1
2	1.13 Coaxial Cable	OD.113.CM	FEP	Gray	1
3	IPEX MHF1 Connector	IPEX.MHFI.113	Brass	Gold Plated	1
4	Shielding Case		Tin (SPTE)	Tin Plated	1
5	PCB		FR4 0.8t	Green	1

8. Plugs Usage Precautions

8.1 Mating / unmating

(1) To disconnect connectors, insert the end portion of I-PEX under the connector flanges and pull off vertically, in the direction of the connector mating axis.

(2) To mate the connectors, the mating axes of both connectors must be aligned and the connectors can be mated. The "click" will confirm fully mated connection.

Do not attempt to insert on an extreme angle.

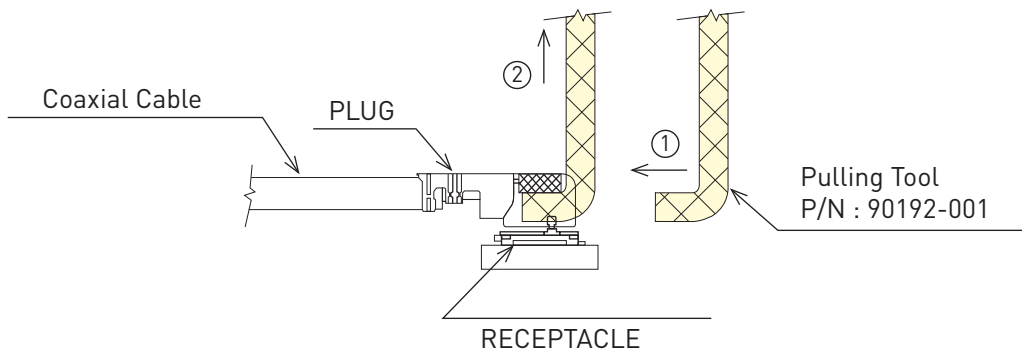

8.2 Pull forces on the cable after connectors are mated

After the connectors are mated, do not apply a load to the cable in excess of the values indicated in the diagram below.

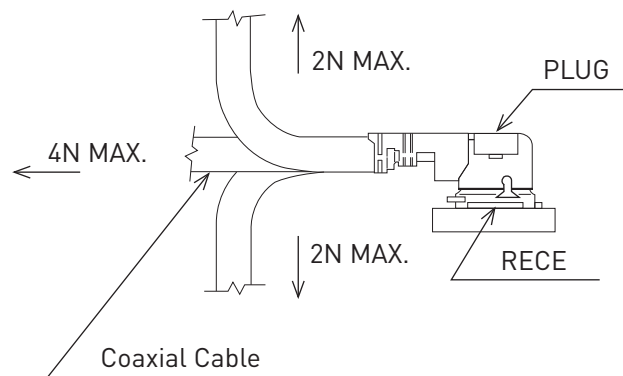

9. Packaging

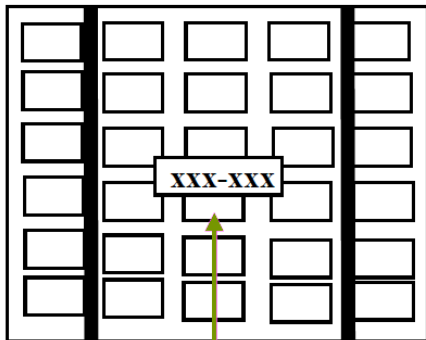

- *Packaged in Tray with Foam
- *One Tray = 60 pieces
- *6 Trays per Section = 360 pcs

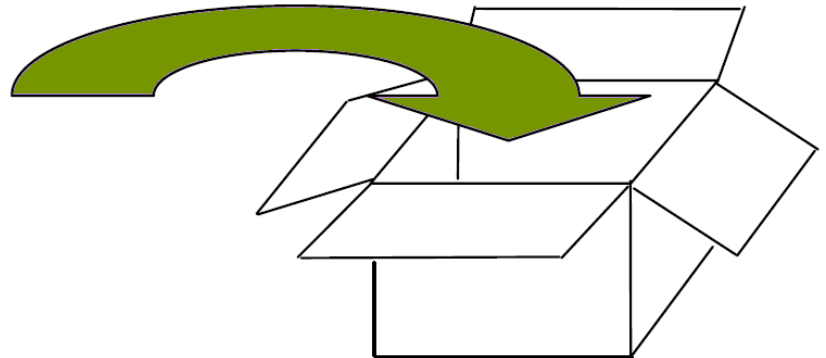

- *Each Carton contains 3 Sections
- *1080 pieces per Carton

Taoglas makes no warranties based on the accuracy or completeness of the contents of this document and reserves the right to make changes to specifications and

product descriptions at any time without notice.

Taoglas reserves all rights to this document and the information

contained herein. Reproduction, use or disclosure to third parties without express permission is strictly prohibited. Copyright © 2012, Taoglas Ltd.