

DETAILS

Product Number	CA10930_BOOM-M
Family	Boom
Type	RefAssy
Color	metal
Diameter	22,2 mm
Height	14,34 mm
Style	hexag
Optic Material	
Holder Material	
Fastening	glue, tape
Status	production ready
ROHS Compliant	Yes
Date Updated	8/02/2017



OPTICAL PROPERTIES

LED	Viewing	Light	Effi-		Connector
	Angle	Beam	ciency	cd/lm	
MHD-E/G	34 deg	Medium	82 %	1.700	-
MHB-A	31 deg	Medium	82 %	2.230	-
LUXEON M/MX	30 deg	Medium	79 %	2.240	-
LUXEON MZ	20 deg	Medium	75 %	4.000	-
NFMW48xA	23 deg	Medium	80 %	3.100	-
Duris S10	28 deg	Medium	74 %	2.500	-
Duris P10	sim: 25	Medium	sim: 85 %	sim: 3.320	-
P7	33 deg	Medium	-	1.860	-

Relative intensity of CA10930_BOOM-M_(MH-B)

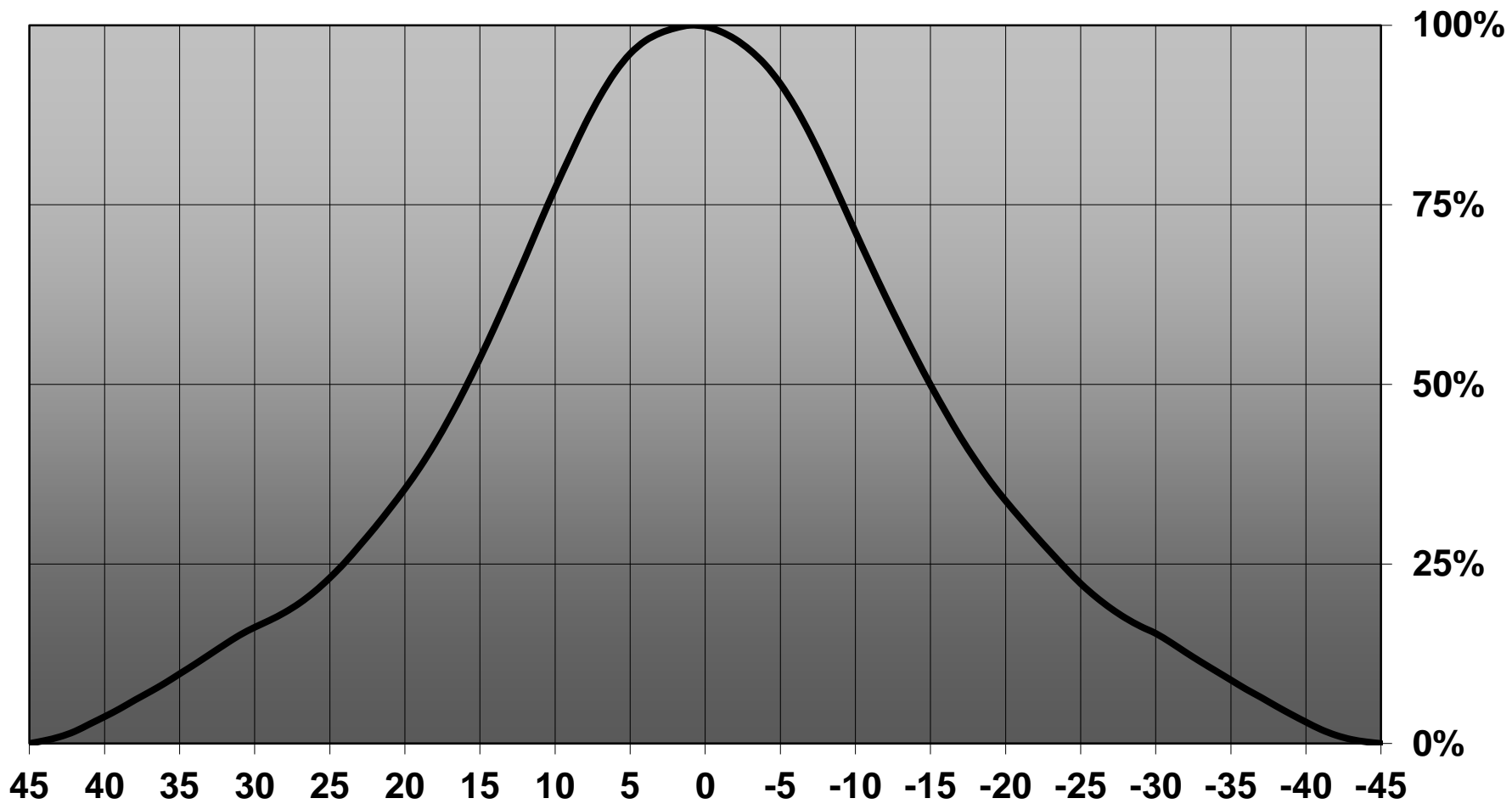

Relative intensity of CA10930_BOOM-M_(Duris_S10)

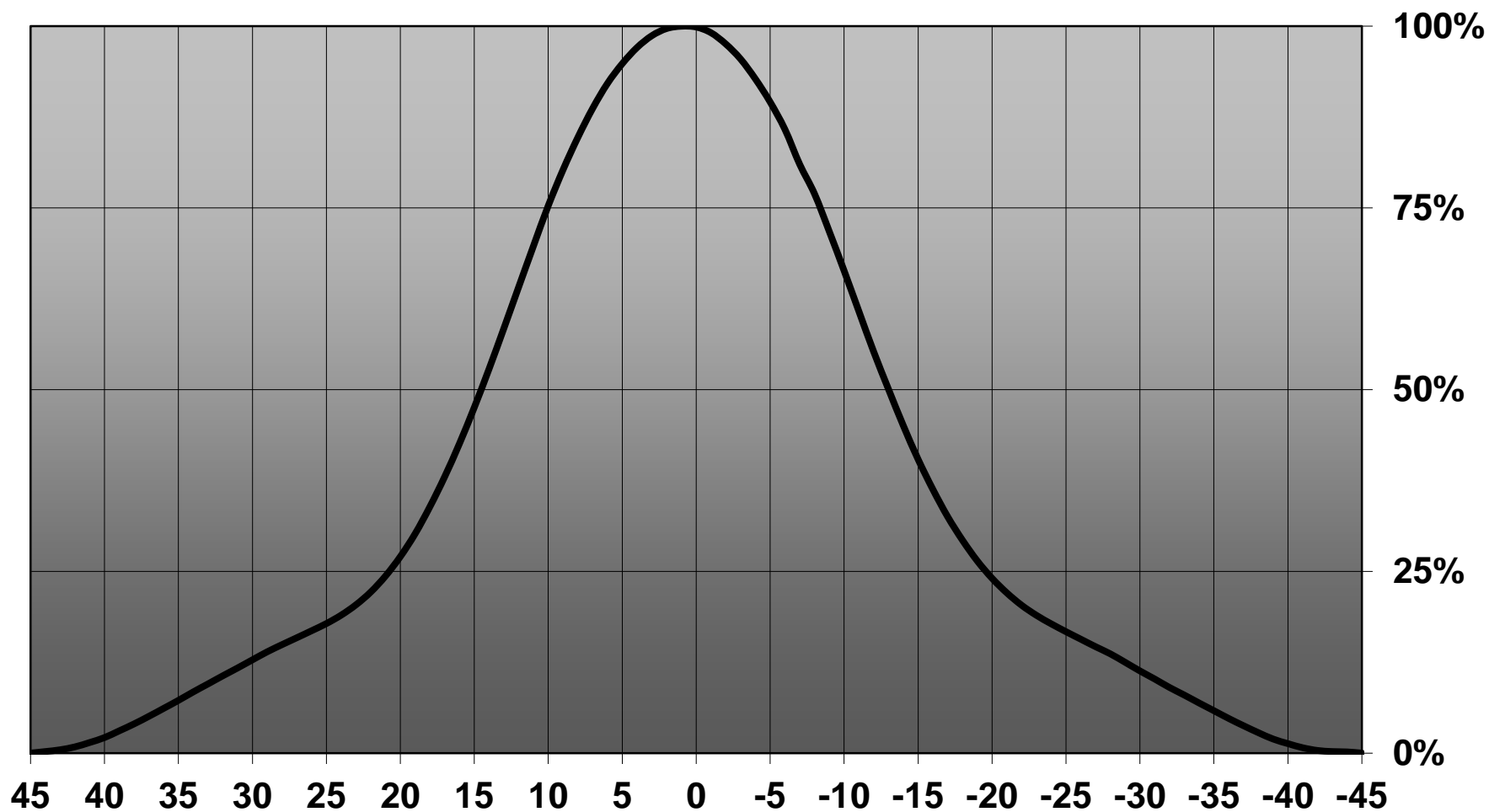

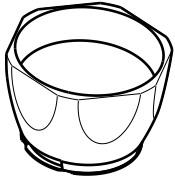

Isometric view
Scale: 1:1

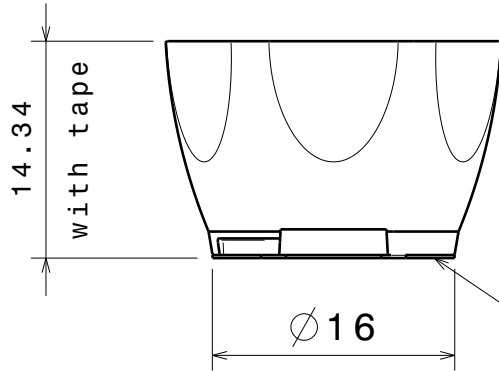

Front view
Scale: 2:1

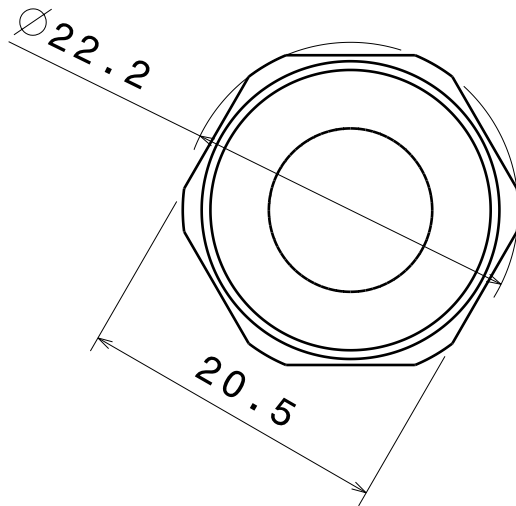

Top view
Scale: 2:1

Part no.s:
Spot CA10715
Medium CA10930
Wide CA10931

INDEX	PART NO	DESCRIPTION	MATERIAL	COLOUR
1	-	Boom-reflector	PC	metal

Tolerances if not otherwise shown
According to DIN ISO 2768-1
Linear measures:
Up to 30mm class M, otherwise class C.
According to DIN ISO 2768-2
Form and position: class L

LEDiL

Ledil Oy
Salorankatu 10
FIN 24240 SALO
Finland

THIRD ANGLE PROJECTION:

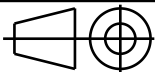

DRAWING TITLE

Boom reflector

This drawing is the property
of LEDiL Oy. It may not be
reproduced, copied or
communicated without a written
agreement with LEDiL Oy.

SIZE PART NUMBER

A4 CA10715, CA10930, CA10931

SCALE 2:1 WEIGHT 1,25 g SHEET 1/1

Luminaire: Ledil CA10930_BOOM-M_(MHD-G)

Lamps: 1 x Cree MHD-G_530.44lm@100mA_P=3.0W_I=0.100A

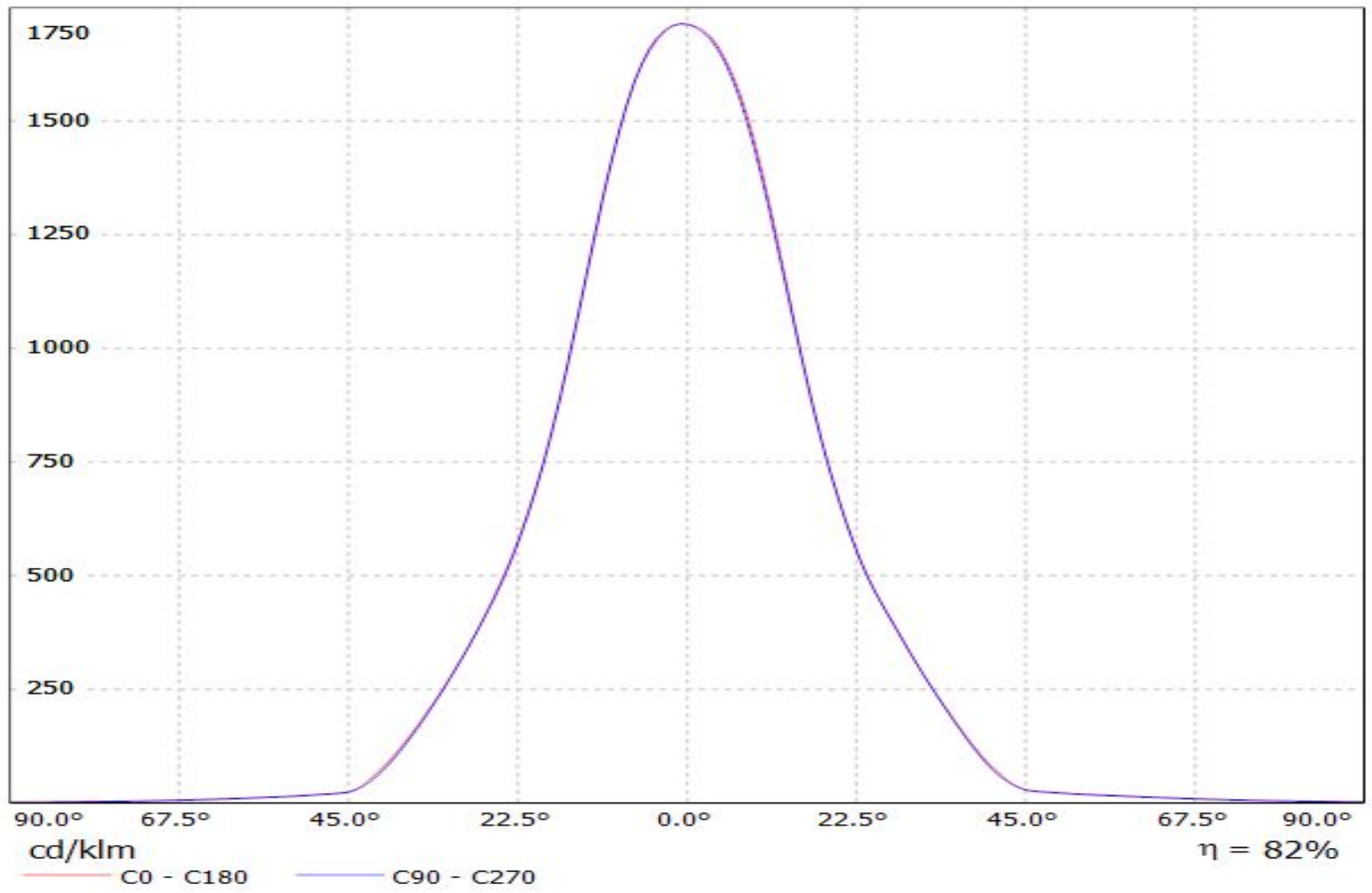

Luminaire: Ledil Oy CA10930_BOOM-M (Luxeon M 348lm @ 250mA) Efficiency=79%
Lamps: 1 x Luxeon M 348lm @ 250mA

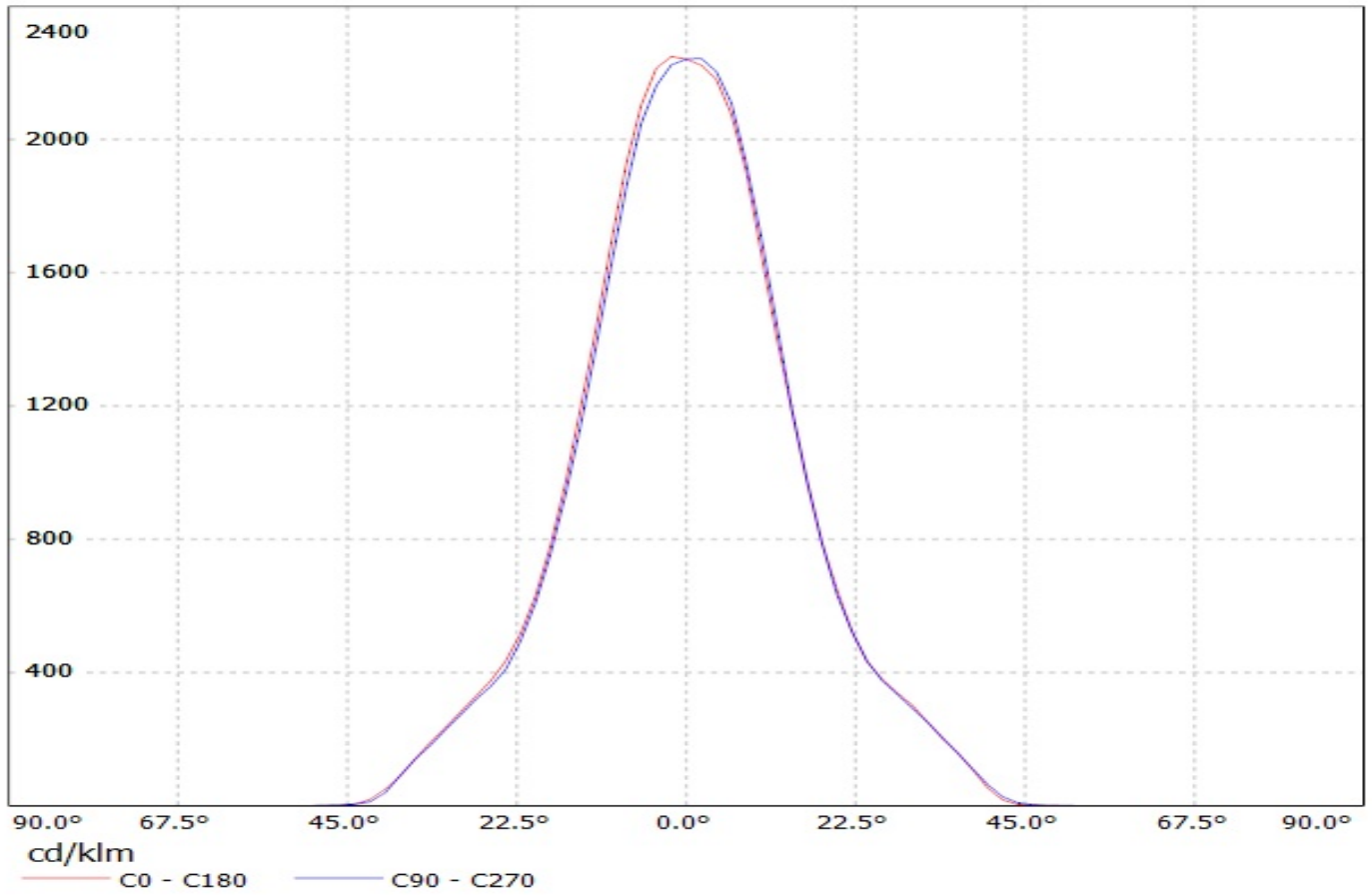

Luminaire: LEDil Oy CA10930_BOOM-M_(Luxeon_MZ) Efficiency=75%
Lamps: 1 x Philips Lumileds Luxeon MZ (389lm @ 250mA) CCT=3800K P=2.8W I=250mA

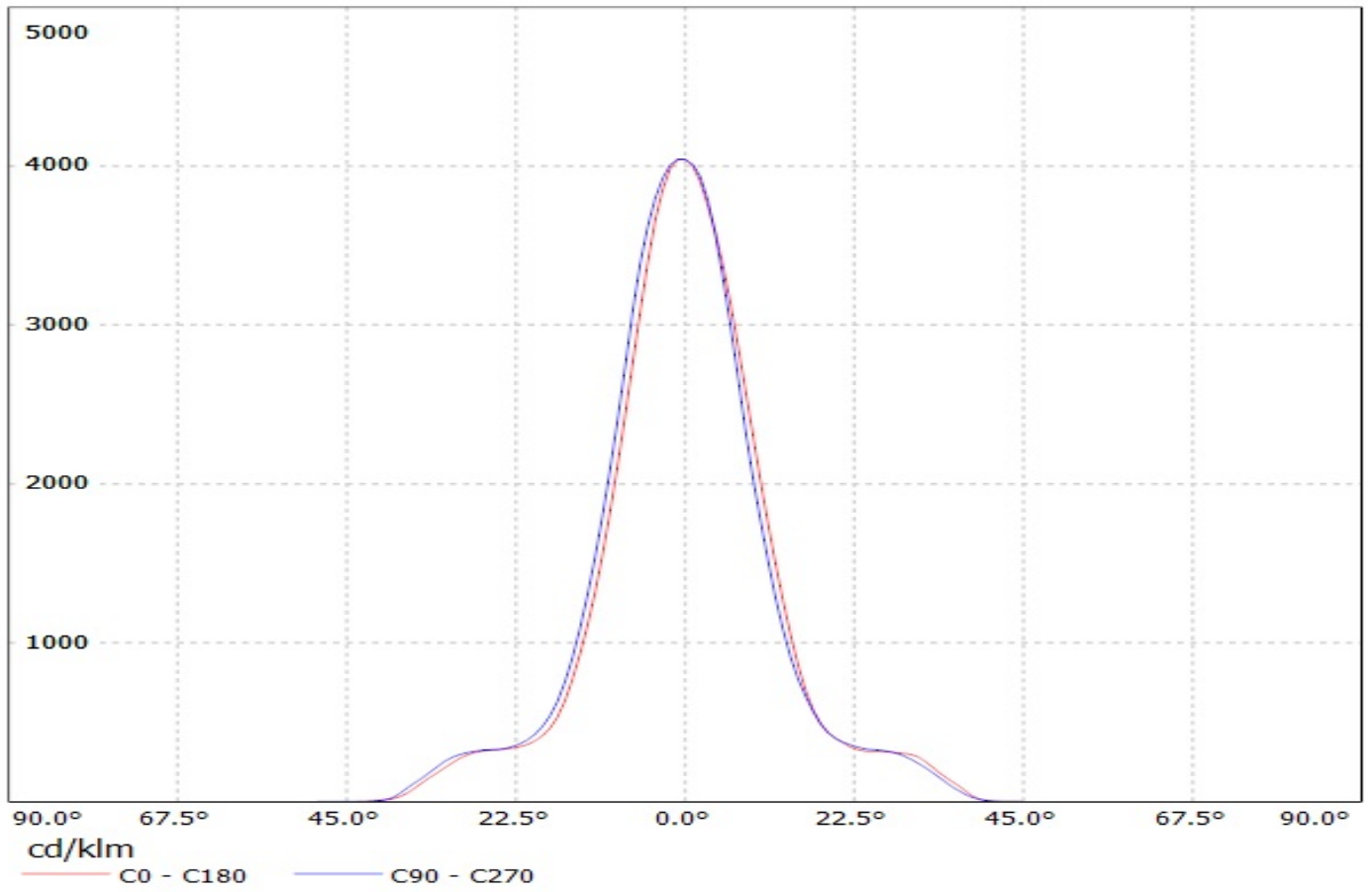

Luminaire: LEDiL Oy CA10930_BOOM-M_(NFMX48xAR_14chip)

Lamps: 1 x Nichia_NFMX48xAR_14chip_(NFMW488AR)_561.275lm@100mA_P=4.11057W_I=0.100A

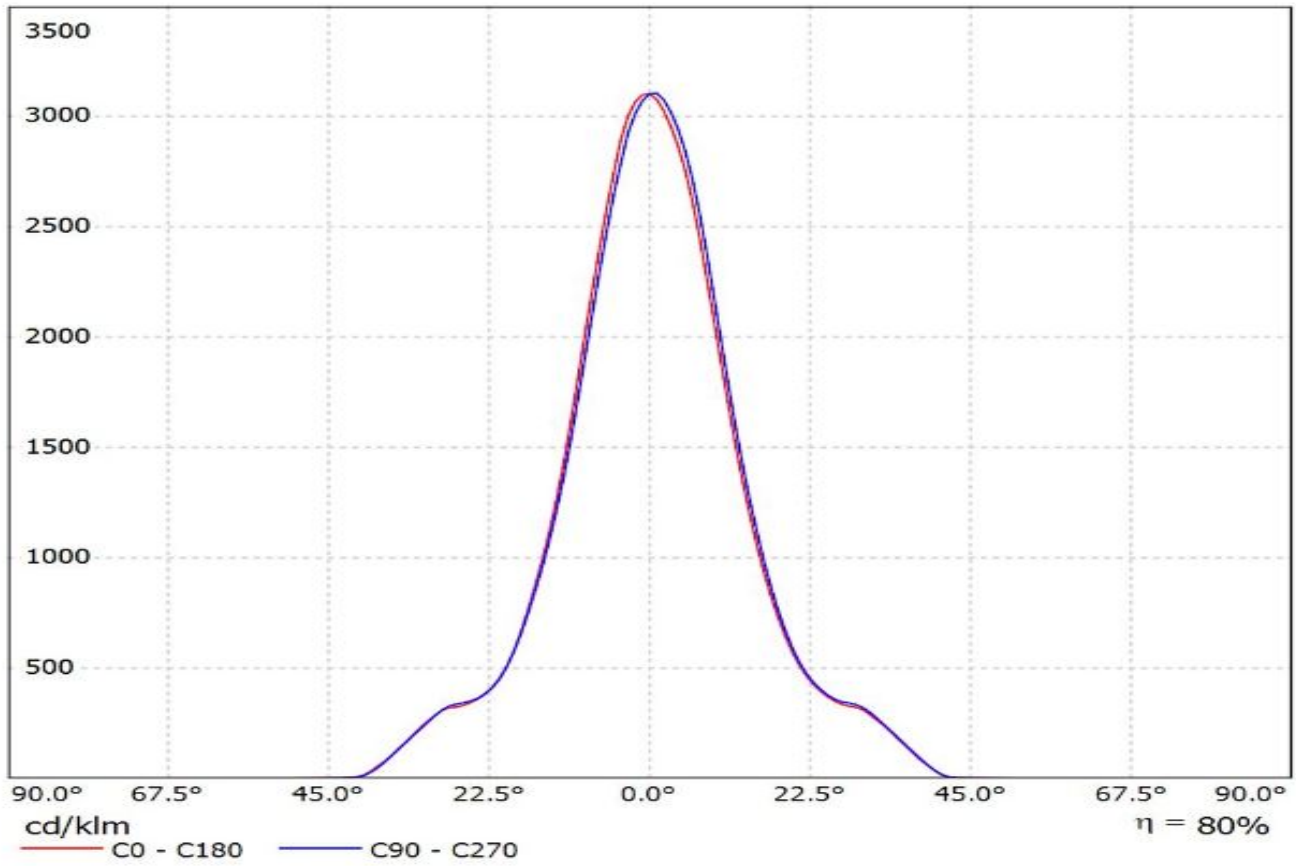

Luminaire: Ledil CA10930_BOOM-M_(MHD-G)

Lamps: 1 x Cree MHD-G_530.44lm@100mA_P=3.0W_I=0.100A

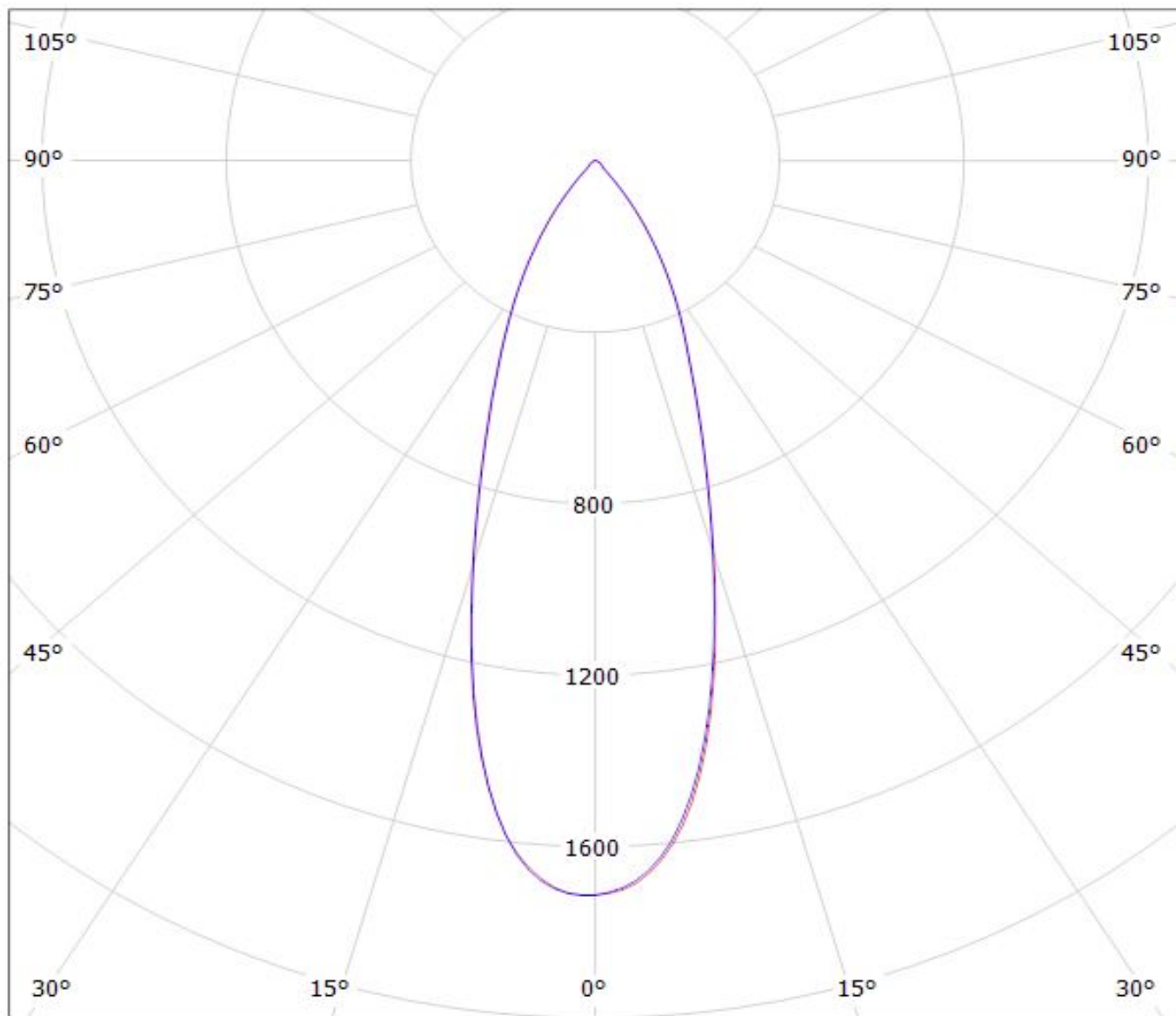

cd/klm

— C0 - C180

— C90 - C270

$\eta = 82\%$

Luminaire: Ledil Oy CA10930_BOOM-M (Luxeon M 348lm @ 250mA) Efficiency=79%
Lamps: 1 x Luxeon M 348lm @ 250mA

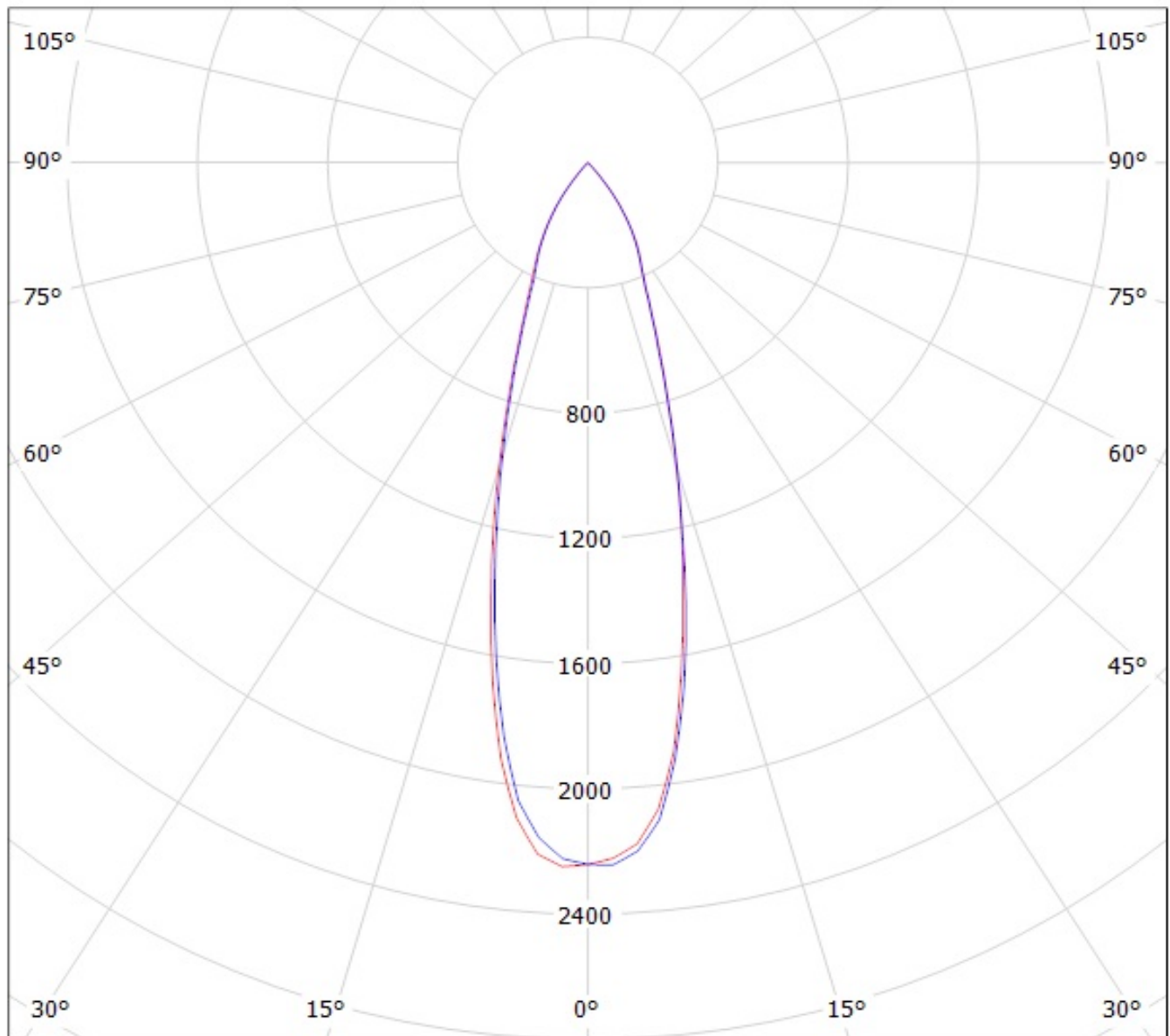

cd/klm

— C0 - C180

— C90 - C270

Luminaire: LEDil Oy CA10930_BOOM-M_(Luxeon_MZ) Efficiency=75%
Lamps: 1 x Philips Lumileds Luxeon MZ (389lm @ 250mA) CCT=3800K P=2.8W I=250mA

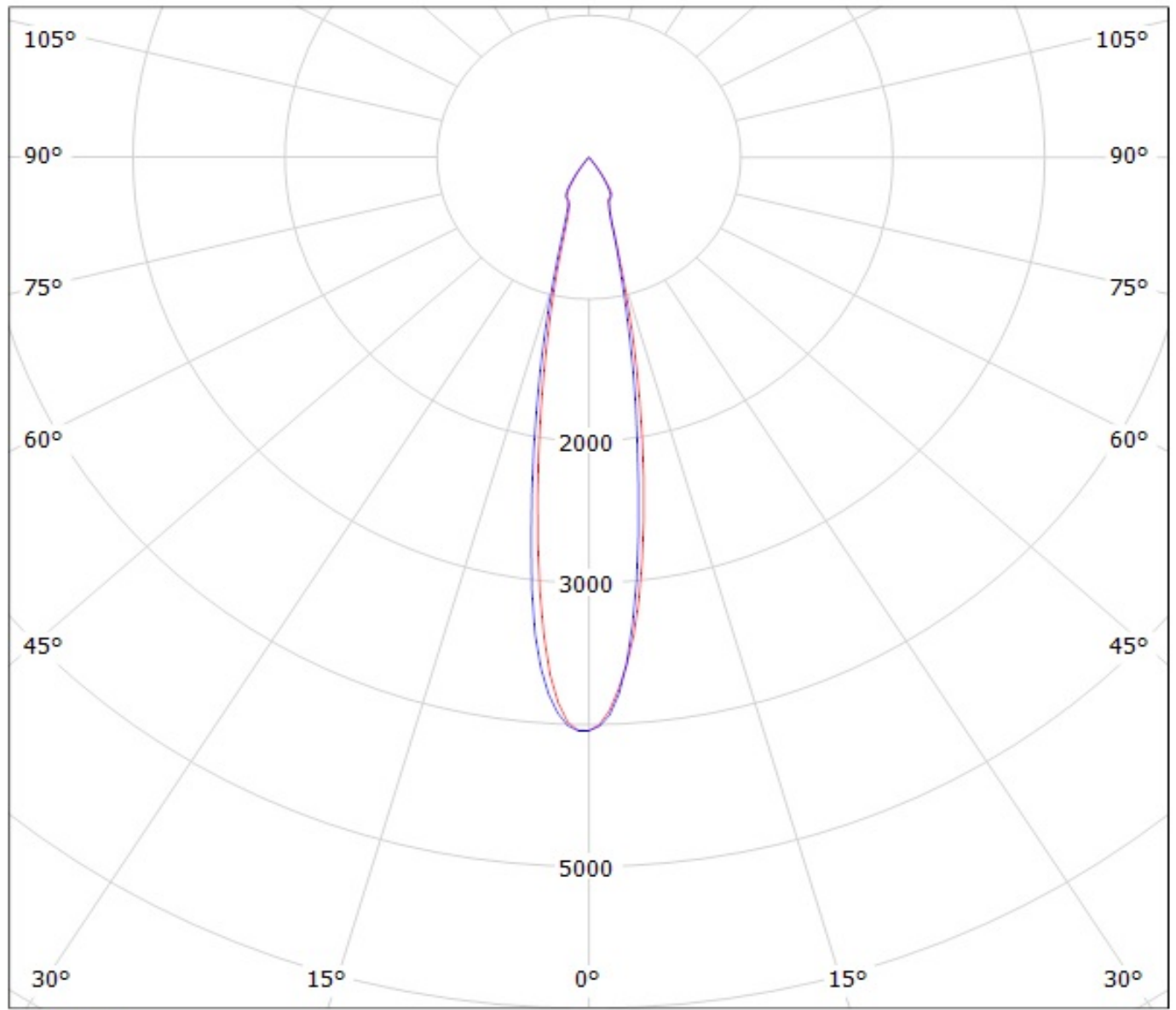

cd/klm

— C0 - C180 — C90 - C270

Luminaire: LEDiL Oy CA10930_BOOM-M_(NFMX48xAR_14chip)

Lamps: 1 x Nichia_NFMX48xAR_14chip_(NFMW488AR)_561.275lm@100mA_P=4.11057W_η=0.100A

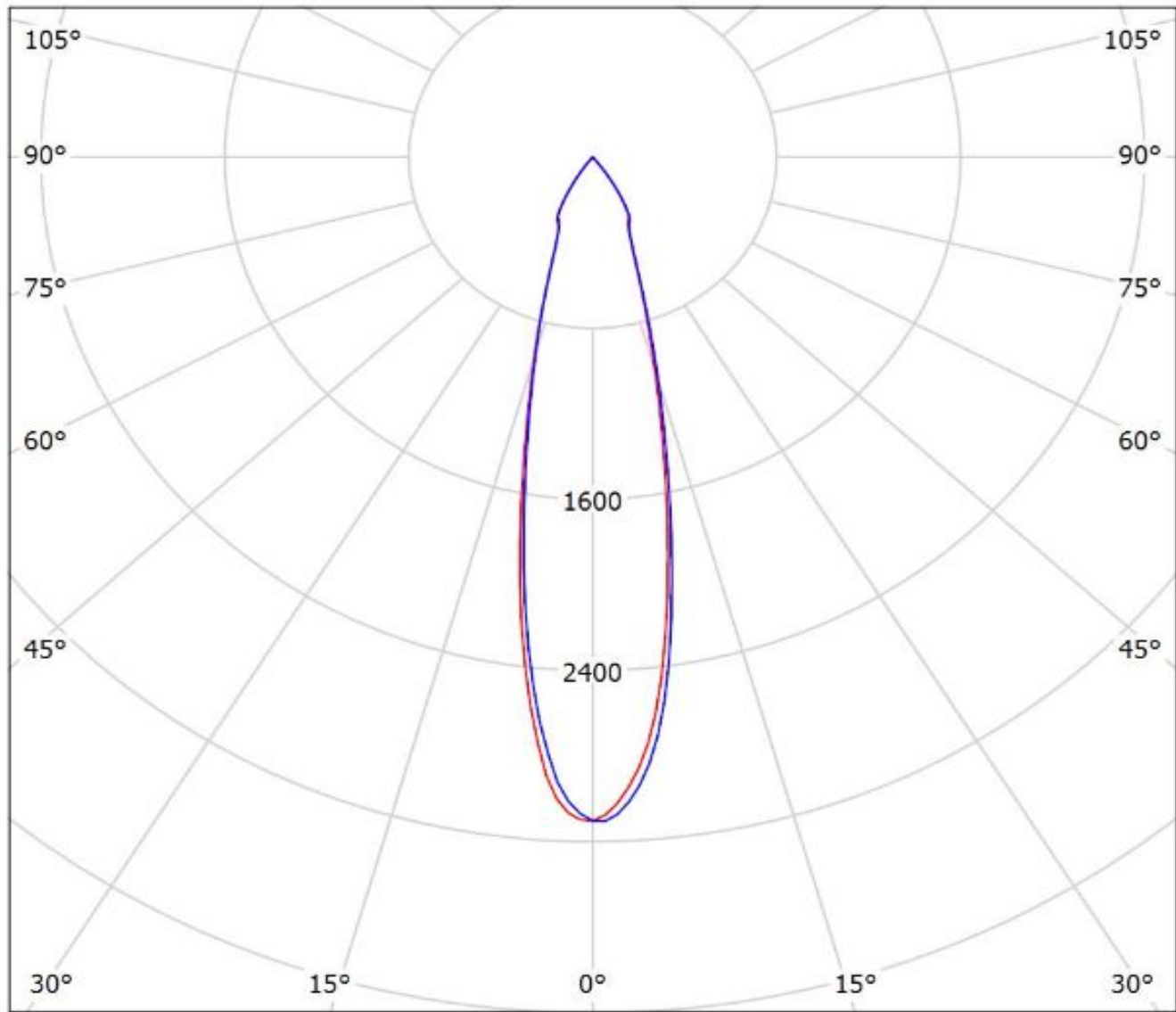

cd/klm

— C0 - C180 — C90 - C270

η = 80%

NOTE: The typical divergence will be changed by different color, chip size and chip position tolerance. The typical total divergence is the full angle measured where the luminous intensity is half of the peak value.