

GMSTBO 2,5 HV/ 3-GL-7,25 THR

Order No.: 2199663

<http://eshop.phoenixcontact.de/phoenix/treeViewClick.do?UID=2199663>Header, Nominal current: 16 A, Rated voltage (III/2): 630 V, Color:
black, Assembly: SMD/THT/THR**Commercial data**

GTIN (EAN)	 4 046356 495295
Note	Made-to-order
sales group	F057
Pack	50 pcs.
Customs tariff	85366990
Catalog page information	Page 180 (NTK-2010)

Product notesWEEE/RoHS-compliant since:
02/19/2009

<http://www.download.phoenixcontact.com>
Please note that the data given here has been taken from the online catalog. For comprehensive information and data, please refer to the user documentation. The General Terms and Conditions of Use apply to Internet downloads.

Technical data**Dimensions / positions**

Dimension a	14.5 mm
Pin dimensions	1,0 x 1,0 mm
Pin spacing	7.25 mm
Hole diameter	1.5 mm

Technical data

Insulating material group	IIIa
Rated surge voltage (III/3)	6 kV
Rated surge voltage (III/2)	6 kV
Rated surge voltage (II/2)	6 kV
Rated voltage (III/2)	630 V
Rated voltage (II/2)	630 V
Connection in acc. with standard	EN-VDE
Nominal current I_N	16 A
Nominal voltage U_N	400 V
Maximum load current	16 A
Insulating material	LCP
Inflammability class acc. to UL 94	V0

Diagrams/Drawings

Drilling plan/solder pad geometry

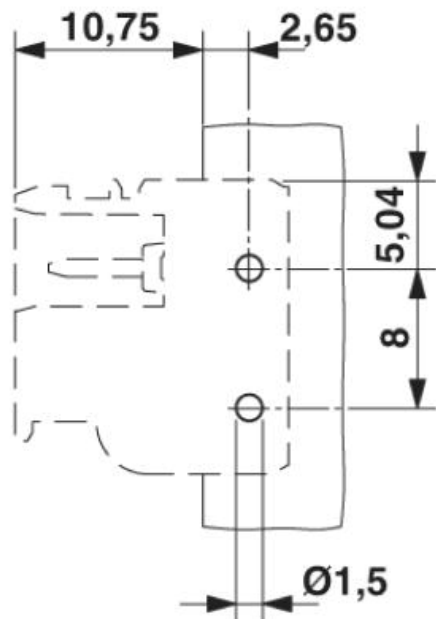

Dimensioned drawing

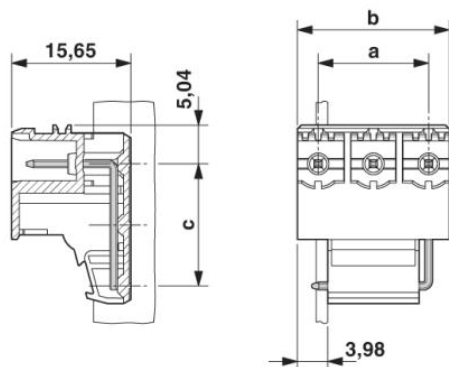

Address

PHOENIX CONTACT Inc., USA
586 Fulling Mill Road
Middletown, PA 17057, USA
Phone (800) 888-7388
Fax (717) 944-1625
<http://www.phoenixcon.com>



© 2011 Phoenix Contact
Technical modifications reserved;