



Is Now Part of



ON Semiconductor®

To learn more about ON Semiconductor, please visit our website at
www.onsemi.com

ON Semiconductor and the ON Semiconductor logo are trademarks of Semiconductor Components Industries, LLC dba ON Semiconductor or its subsidiaries in the United States and/or other countries. ON Semiconductor owns the rights to a number of patents, trademarks, copyrights, trade secrets, and other intellectual property. A listing of ON Semiconductor's product/patent coverage may be accessed at www.onsemi.com/site/pdf/Patent-Marking.pdf. ON Semiconductor reserves the right to make changes without further notice to any products herein. ON Semiconductor makes no warranty, representation or guarantee regarding the suitability of its products for any particular purpose, nor does ON Semiconductor assume any liability arising out of the application or use of any product or circuit, and specifically disclaims any and all liability, including without limitation special, consequential or incidental damages. Buyer is responsible for its products and applications using ON Semiconductor products, including compliance with all laws, regulations and safety requirements or standards, regardless of any support or applications information provided by ON Semiconductor. "Typical" parameters which may be provided in ON Semiconductor data sheets and/or specifications can and do vary in different applications and actual performance may vary over time. All operating parameters, including "Typicals" must be validated for each customer application by customer's technical experts. ON Semiconductor does not convey any license under its patent rights nor the rights of others. ON Semiconductor products are not designed, intended, or authorized for use as a critical component in life support systems or any FDA Class 3 medical devices or medical devices with a same or similar classification in a foreign jurisdiction or any devices intended for implantation in the human body. Should Buyer purchase or use ON Semiconductor products for any such unintended or unauthorized application, Buyer shall indemnify and hold ON Semiconductor and its officers, employees, subsidiaries, affiliates, and distributors harmless against all claims, costs, damages, and expenses, and reasonable attorney fees arising out of, directly or indirectly, any claim of personal injury or death associated with such unintended or unauthorized use, even if such claim alleges that ON Semiconductor was negligent regarding the design or manufacture of the part. ON Semiconductor is an Equal Opportunity/Affirmative Action Employer. This literature is subject to all applicable copyright laws and is not for resale in any manner.

FST6800

10-Bit Bus Switch with Precharged Outputs

General Description

The Fairchild Switch FST6800 provides 10-bits of high-speed CMOS TTL-compatible bus switching. The low on resistance of the switch allows inputs to be connected to outputs without adding propagation delay or generating additional ground bounce noise. The device precharges the B Port to a selectable bias voltage (BiasV) to minimize live insertion noise.

The device is organized as a 10-bit switch with a bus enable (\overline{OE}) signal. When \overline{OE} is LOW, the switch is ON and Port A is connected to Port B. When \overline{OE} is HIGH, the switch is OPEN and the B Port is precharged to BiasV through an equivalent 10-k Ω resistor.

Features

- 4 Ω switch connection between two ports.
- Minimal propagation delay through the switch.
- Low I_{CC} .
- Zero bounce in flow-through mode.
- Output precharge to minimize live insertion noise.
- Control inputs compatible with TTL level.

Ordering Code:

| Order Number | Package Number | Package Description |
|--------------|----------------|---|
| FST6800WM | M24B | 24-Lead Small Outline Integrated Circuit (SOIC), JEDEC MS-013, 0.300 Wide |
| FST6800QSC | MQA24 | 24-Lead Quarter Size Outline Package (QSOP), JEDEC MO-137, 0.150 Wide |
| FST6800MTC | MTC24 | 24-Lead Thin Shrink Small Outline Package (TSSOP), JEDEC MO-153, 4.4mm Wide |

Devices also available in Tape and Reel. Specify by appending the suffix letter "X" to the ordering code.

Logic Diagram

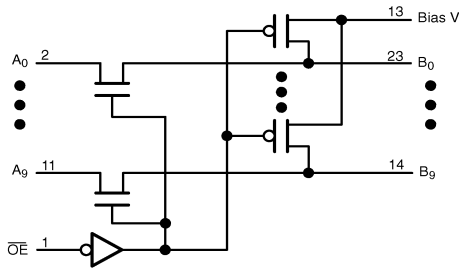

Connection Diagram

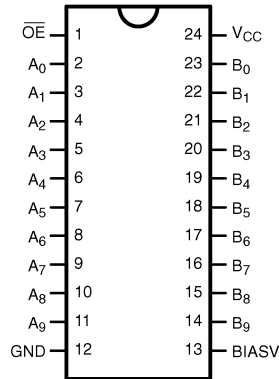

Pin Descriptions

| Pin Name | Description |
|-----------------|-------------------|
| \overline{OE} | Bus Switch Enable |
| A | Bus A |
| B | Bus B |

Truth Table

| \overline{OE} | B ₀ -B ₉ | Function |
|-----------------|--------------------------------|-----------|
| L | A ₀ -A ₉ | Connect |
| H | BiasV | Precharge |

Absolute Maximum Ratings (Note 1)

| | |
|---|------------------|
| Supply Voltage (V_{CC}) | -0.5V to +7.0V |
| DC Switch Voltage (V_S) | -0.5V to +7.0V |
| Bias V Voltage Range | -0.5V to +6.0V |
| DC Input Voltage (V_{IN}) (Note 2) | -0.5V to +7.0V |
| DC Input Diode Current (I_{IK}) $V_{IN} < 0V$ | -50mA |
| DC Output (I_{OUT}) Sink Current | 128mA |
| DC V_{CC}/GND Current (I_{CC}/I_{GND}) | +/- 100mA |
| Storage Temperature Range (T_{STG}) | -65°C to +150 °C |

Recommended Operating Conditions (Note 3)

| | |
|--|------------------|
| Power Supply Operating (V_{CC}) | 4.0V to 5.5V |
| Precharge Supply (BiasV) | 1.5V to V_{CC} |
| Input Voltage (V_{IN}) | 0V to 5.5V |
| Output Voltage (V_{OUT}) | 0V to 5.5V |
| Input Rise and Fall Time (t_r, t_f) | |
| Switch Control Input | 0nS/V to 5nS/V |
| Switch I/O | 0nS/V to DC |
| Free Air Operating Temperature (T_A) | -40 °C to +85 °C |

Note 1: The Absolute Maximum Ratings are those values beyond which the safety of the device cannot be guaranteed. The device should not be operated at these limits. The parametric values defined in the Electrical Characteristics tables are not guaranteed at the absolute maximum ratings. The Recommended Operating Conditions tables will define the conditions for actual device operation.

Note 2: The input and output negative voltage ratings may be exceeded if the input and output diode current ratings are observed.

Note 3: Unused control inputs must be held HIGH or LOW. They may not float.

DC Electrical Characteristics

| Symbol | Parameter | V_{CC} (V) | $T_A = -40\text{ °C to }+85\text{ °C}$ | | | Units | Conditions |
|-----------------|----------------------------------|-----------------|--|-----------------|-----------|---------------|--|
| | | | Min | Typ (Note 4) | Max | | |
| V_{IK} | Clamp Diode Voltage | 4.5 | | | -1.2 | V | $I_{IN} = -18\text{mA}$ |
| V_{IH} | HIGH Level Input Voltage | 4.0-5.5 | 2.0 | | | V | |
| V_{IL} | LOW Level Input Voltage | 4.0-5.5 | | | 0.8 | V | |
| I_I | Input Leakage Current | 5.5 | | | ± 1.0 | μA | $0 \leq V_{IN} \leq 5.5\text{V}$ |
| I_O | Output Current | 4.5 | 0.25 | | | mA | BiasV = 2.4V, B = 0 |
| I_{OZ} | OFF-STATE Leakage Current | 5.5 | | | ± 1.0 | μA | $0 \leq A \leq V_{CC}$ |
| R_{ON} | Switch On Resistance (Note 5) | 4.5 | | 4 | 7 | Ω | $V_{IN} = 0\text{V}, I_{IN} = 64\text{mA}$ |
| | | 4.5 | | 4 | 7 | Ω | $V_{IN} = 0\text{V}, I_{IN} = 30\text{mA}$ |
| | | 4.5 | | 8 | 15 | Ω | $V_{IN} = 2.4\text{V}, I_{IN} = 15\text{mA}$ |
| | | 4.0 | | 11 | 20 | Ω | $V_{IN} = 2.4\text{V}, I_{IN} = 15\text{mA}$ |
| I_{CC} | Quiescent Supply Current | 5.5 | | | 3 | μA | $V_{IN} = V_{CC}$ or GND, $I_{OUT} = 0$ |
| ΔI_{CC} | Increase in I_{CC} per Input | 5.5 | | | 2.5 | mA | One input at 3.4V Other inputs at V_{CC} or GND |

Note 4: Typical values are at $V_{CC} = 5.0\text{V}$ and $T_A = +25\text{ °C}$

Note 5: Measured by the voltage drop between A and B pins at the indicated current through the switch. On resistance is determined by the lower of the voltages on the two (A or B) pins.

AC Electrical Characteristics

| Symbol | Parameter | $T_A = -40\text{ }^\circ\text{C to } +85\text{ }^\circ\text{C},$ $C_L = 50\text{pF}, R_U = R_D = 500\Omega$ | | | | Units | Conditions | Figure No. |
|--------------------|--------------------------------|--|------|------------------------|------|-------|--|--------------|
| | | $V_{CC} = 4.5 - 5.5\text{V}$ | | $V_{CC} = 4.0\text{V}$ | | | | |
| | | Min | Max | Min | Max | | | |
| t_{PHL}, t_{PLH} | Prop Delay Bus to Bus (Note 6) | | 0.25 | | 0.25 | ns | $V_I = \text{OPEN}$ | Figures 1, 2 |
| t_{PZH} | Output Enable Time | 1.5 | 6.2 | | 6.5 | ns | $V_I = \text{OPEN}, \text{BiasV} = \text{GND}$ | Figures 1, 2 |
| t_{PZL} | | 1.5 | 6.2 | | 6.5 | ns | $V_I = 7\text{V}, \text{BiasV} = 3\text{V}$ | |
| t_{PHZ} | Output Disable Time | 1.5 | 6.1 | | 6.5 | ns | $V_I = \text{OPEN}, \text{BiasV} = \text{GND}$ | Figures 1, 2 |
| t_{PLZ} | | 1.5 | 7.3 | | 6.8 | ns | $V_I = 7\text{V}, \text{BiasV} = 3\text{V}$ | |

Note 6: This parameter is guaranteed by design but is not tested. The bus switch contributes no propagation delay other than the RC delay of the typical On resistance of the switch and the 50pF load capacitance, when driven by an ideal voltage source (zero output impedance).

Capacitance (Note 7)

| Symbol | Parameter | Typ | Max | Units | Conditions |
|-----------|-------------------------------|-----|-----|-------|--|
| C_{IN} | Control Pin Input Capacitance | 3 | | pF | $V_{CC} = 5.0\text{V}$ |
| $C_{I/O}$ | Input/Output Capacitance | 5 | | pF | $V_{CC}, \overline{\text{OE}} = 5.0\text{V}$ |

Note 7: $T_A = +25\text{ }^\circ\text{C}, f = 1\text{ MHz}$, Capacitance is characterized but not tested.

AC Loading and Waveforms

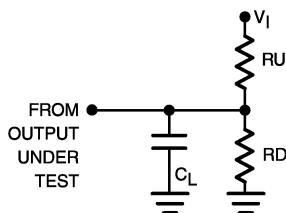

Note: Input driven by 50 Ω source terminated in 50 Ω

Note: C_L includes load and stray capacitance

Note: Input PRR = 1.0 MHz, $t_W = 500\text{ ns}$

FIGURE 1. AC Test Circuit

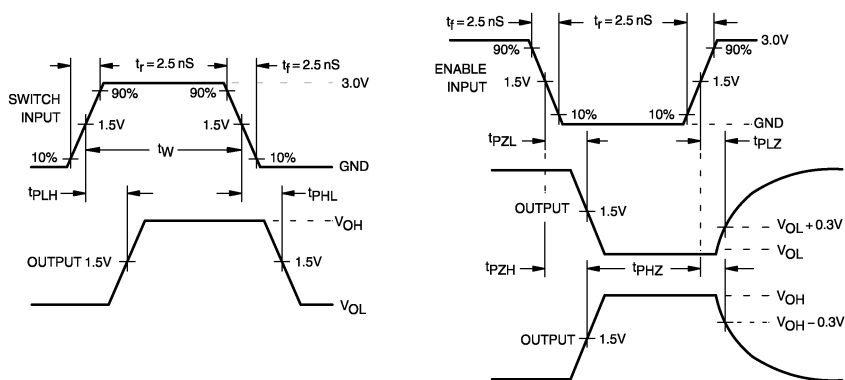
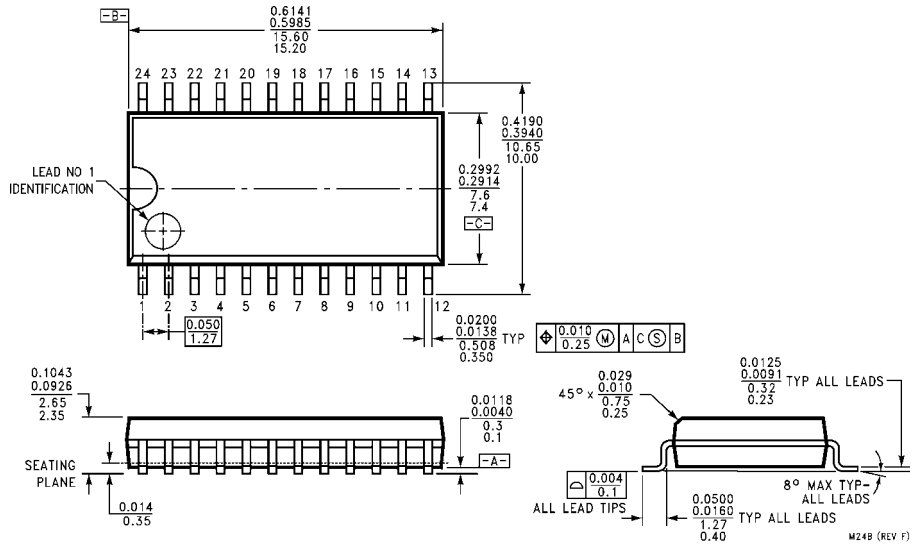
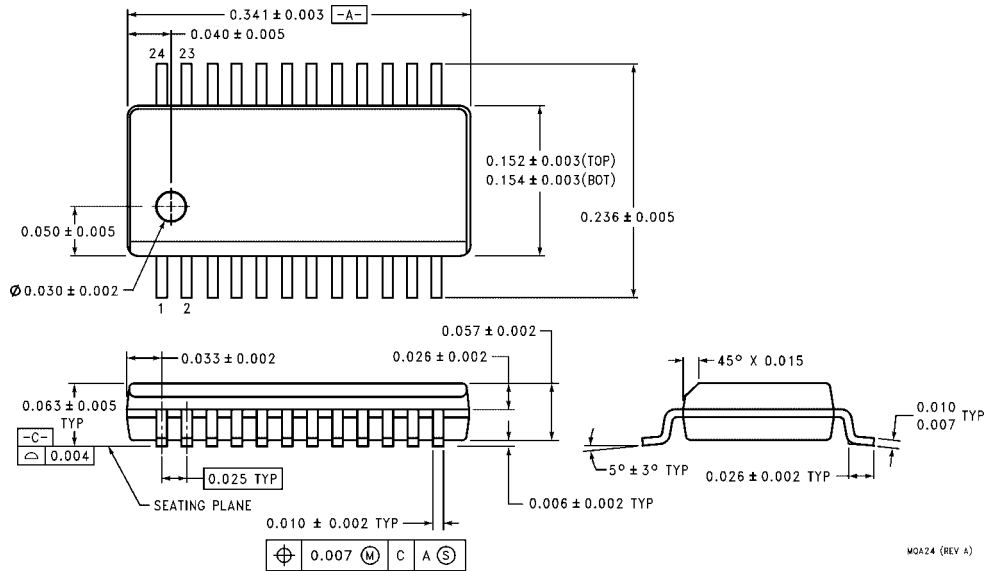

FIGURE 2. AC Waveforms

Physical Dimensions inches (millimeters) unless otherwise noted



24-Lead Small Outline Integrated Circuit (SOIC), JEDEC MS-013, 0.300 Wide Package Number M24B



24-Lead Quarter Size Outline Package (QSOP), JEDEC MO-137, 0.150 Wide Package Number MQA24

Physical Dimensions inches (millimeters) unless otherwise noted (Continued)

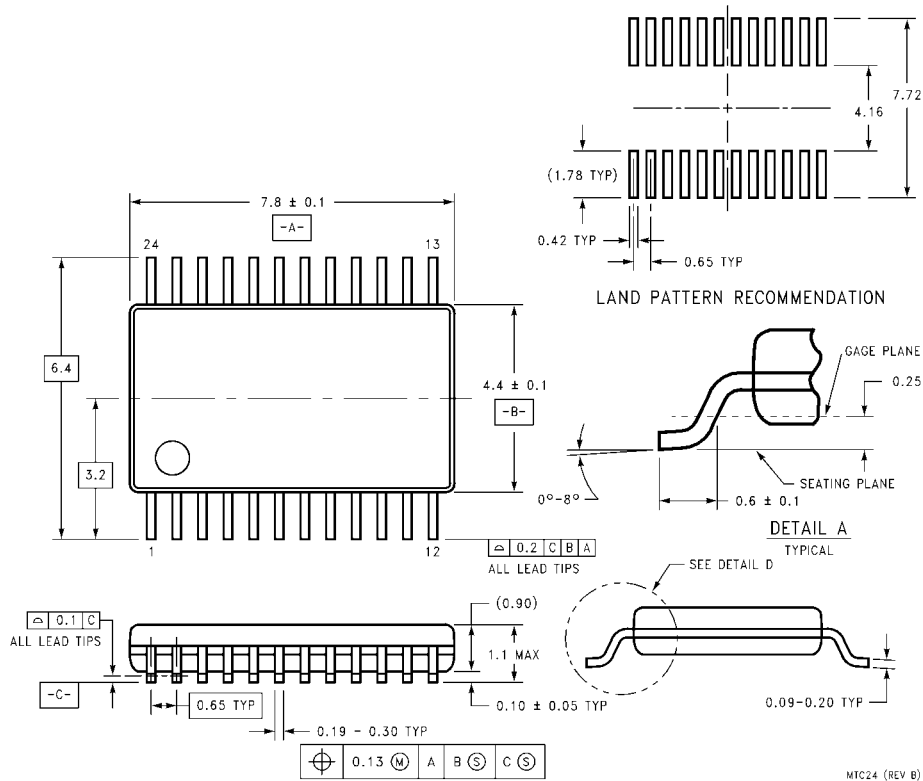

**24-Lead Thin Shrink Small Outline Package (TSSOP), JEDEC MO-153, 4.4mm Wide
Package Number MTC24**

Technology Description

The Fairchild Switch family derives from and embodies Fairchild's proven switch technology used for several years in its 74LVX3L384 (FST3384) bus switch product.

Fairchild does not assume any responsibility for use of any circuitry described, no circuit patent licenses are implied and Fairchild reserves the right at any time without notice to change said circuitry and specifications.

LIFE SUPPORT POLICY

FAIRCHILD'S PRODUCTS ARE NOT AUTHORIZED FOR USE AS CRITICAL COMPONENTS IN LIFE SUPPORT DEVICES OR SYSTEMS WITHOUT THE EXPRESS WRITTEN APPROVAL OF THE PRESIDENT OF FAIRCHILD SEMICONDUCTOR CORPORATION. As used herein:

1. Life support devices or systems are devices or systems which, (a) are intended for surgical implant into the body, or (b) support or sustain life, and (c) whose failure to perform when properly used in accordance with instructions for use provided in the labeling, can be reasonably expected to result in a significant injury to the user.
2. A critical component in any component of a life support device or system whose failure to perform can be reasonably expected to cause the failure of the life support device or system, or to affect its safety or effectiveness.

www.fairchildsemi.com

ON Semiconductor and  are trademarks of Semiconductor Components Industries, LLC dba ON Semiconductor or its subsidiaries in the United States and/or other countries. ON Semiconductor owns the rights to a number of patents, trademarks, copyrights, trade secrets, and other intellectual property. A listing of ON Semiconductor's product/patent coverage may be accessed at www.onsemi.com/site/pdf/Patent-Marking.pdf. ON Semiconductor reserves the right to make changes without further notice to any products herein. ON Semiconductor makes no warranty, representation or guarantee regarding the suitability of its products for any particular purpose, nor does ON Semiconductor assume any liability arising out of the application or use of any product or circuit, and specifically disclaims any and all liability, including without limitation special, consequential or incidental damages. Buyer is responsible for its products and applications using ON Semiconductor products, including compliance with all laws, regulations and safety requirements or standards, regardless of any support or applications information provided by ON Semiconductor. "Typical" parameters which may be provided in ON Semiconductor data sheets and/or specifications can and do vary in different applications and actual performance may vary over time. All operating parameters, including "Typicals" must be validated for each customer application by customer's technical experts. ON Semiconductor does not convey any license under its patent rights nor the rights of others. ON Semiconductor products are not designed, intended, or authorized for use as a critical component in life support systems or any FDA Class 3 medical devices or medical devices with a same or similar classification in a foreign jurisdiction or any devices intended for implantation in the human body. Should Buyer purchase or use ON Semiconductor products for any such unintended or unauthorized application, Buyer shall indemnify and hold ON Semiconductor and its officers, employees, subsidiaries, affiliates, and distributors harmless against all claims, costs, damages, and expenses, and reasonable attorney fees arising out of, directly or indirectly, any claim of personal injury or death associated with such unintended or unauthorized use, even if such claim alleges that ON Semiconductor was negligent regarding the design or manufacture of the part. ON Semiconductor is an Equal Opportunity/Affirmative Action Employer. This literature is subject to all applicable copyright laws and is not for resale in any manner.

PUBLICATION ORDERING INFORMATION

LITERATURE FULFILLMENT:

Literature Distribution Center for ON Semiconductor
19521 E. 32nd Pkwy, Aurora, Colorado 80011 USA
Phone: 303-675-2175 or 800-344-3860 Toll Free USA/Canada
Fax: 303-675-2176 or 800-344-3867 Toll Free USA/Canada
Email: orderlit@onsemi.com

N. American Technical Support: 800-282-9855 Toll Free
USA/Canada
Europe, Middle East and Africa Technical Support:
Phone: 421 33 790 2910
Japan Customer Focus Center
Phone: 81-3-5817-1050

ON Semiconductor Website: www.onsemi.com
Order Literature: <http://www.onsemi.com/orderlit>
For additional information, please contact your local
Sales Representative