

**Connectivity Solutions for
Industrial Automation**



ALPHA CONNECT



AlphaWire

Cables you trust. Service you deserve.

Table of Contents

Introduction	3
Cordsets	
M8 Connectors	6
M12 Connectors	7
MINI 7/8" Connectors	9
Ethernet Connectors (RJ45 and M12 to RJ45)	10
M23 Connectors	11
Distribution Boxes	
M12 I/O Connectors	12
Thermoplastic Housings	
Die-Cast Housings	13
Stainless Steel Housings	14
M8 I/O Connectors	15
Thermoplastic Housings	
Connectors	
Field Attachable	17
M8, M12, MINI 7/8"	
Receptacle	18
M8, M12, MINI 7/8"	
Splitters	19

Alpha Wire now makes it easier to achieve reliable, high-performance industrial connectivity. Alpha Connect provides an end-to-end solution for connecting sensors and actuators on the factory floor. Alpha Connect ensures safe and reliable communication in industrial environments to decrease downtime and increase productivity.



- Passive distribution boxes with up to twelve M8 or eight M12 ports
- Two-way splitters
- Cordsets with M8, M12, M23, MINI, RJ45 connectors
- Receptacle connectors
- Field attachable connectors

Easy to Use

Distribution boxes mount conveniently at the machine, simplifying wiring and saving space. Boxes are available with or without LED indicators. To speed maintenance and repairs, LEDs simplify troubleshooting to find errors and system malfunctions.

The compact distribution boxes save you space in several ways. They consolidate and simplify wiring from sensors/actuators to the controller. They also eliminate the need for additional enclosures. Some modules support two I/O channels per port so that an 8-port box can handle 16 signals.

Rugged overmolded cordsets, available with connectors on one or both ends, provide a plug and play solution in seven standard lengths to allow shorter installation times. Our field attachable connectors include either solder cups or screw termination for easy field installation to decrease human error.

Easy to Get

With a large in-stock inventory, we make it easy to get the products you need fast.

Mechanically and Environmentally Rugged

Alpha Connect products are designed for the factory floor, with industrial temperature ranges, IP67 sealing, and resistance to vibration, shock, and other hazards. Because the Alpha Connect system offers environmental sealing, the need for additional enclosures is eliminated.

Stainless Steel for Food and Beverage Applications

Stainless-steel models combine IP69K protection and washdown capabilities with additional protection against corrosion and aggressive chemical and cleaning agents.





Flexible Cordsets

Configurations

Connectors: Terminated one or both ends

M8: 3 and 4 conductors

M12: 3, 4, 5, 8, and 12 conductors

M12 D Code: 2 pairs, Ethernet

M12 to RJ45 Ethernet: 4 pairs

M23: 12 and 19 conductors

MINI 7/8": 3, 4, and 5 conductors

RJ45 Ethernet: 2 pairs, shielded or unshielded

Cables

mPPE Insulation, ZH-PUR Jacket, 22 AWG (AWM 21959)

SR-PVC Insulation, -40°C Premium PVC Jacket, 18 AWG (AWM 2661)

SR-PVC Insulation, TPE Jacket, 18 AWG (PLTC, AWM 20327)

SR-PVC Insulation, PVC Jacket, 24 AWG

PVC/Nylon Insulation, TPE Jacket, 16 AWG (TC-ER)

PO Insulation, TPE Jacket, Cat 5e 24 AWG (CMR, CMG)

PP Insulation, ZH-PUR Jacket, 24 AWG (AWM 20549/21198)

Passive Distribution Boxes

Materials

Housing: Die-cast zinc, TPU or stainless steel

Contacts: Copper alloy, plated gold over nickel

Environmental

Temperature Range: Up to +80°C

Sealing: IP67/IP69K

Electrical

Nominal Current at +40°C:

1.5 A to 4 A per port and up to 12 A per module

Nominal Voltage: 10 to 30 VDC

Configurations

M8: 4, 6, 8, 10, or 12 ports

M12: 4, 6, 8 ports

Channels per Port: 1 or 2

LEDs per Port: With or without

Cabled: with 5 m or 10 m homerun cable for direct attachment to controller or similar device

Connectorized: with M12 or M23 connector integrated in housing to accept Alpha Wire cable or cordsets



J W 03 O O 107

CONNECTOR TYPE, END 1

- O** Unterminated / Cut End
- A** M12 Female
- D** M12 Male
- E** M23 Female
- F** M23 Male
- G** M8 Female
- H** M8 Male
- J** MINI Female, 7/8" External Thread
- K** MINI Female, 7/8"
- L** MINI Male, 7/8"
- P** MINI Male, 7/8" Internal Thread
- Q** RJ45

CONNECTOR STYLE, END 1

- O** Unterminated / Cut End
- R** Straight
- W** Right Angle (90°)
- C** Receptacle

NUMBER OF POLES

3, 4, 5, 8

CONNECTOR TYPE, END 2

- O** Unterminated
- A** M12 Female
- D** M12 Male
- E** M23 Female
- F** M23 Male
- G** M8 Female
- H** M8 Male
- J** MINI Female, 7/8" External Thread
- K** MINI Female, 7/8"
- L** MINI Male, 7/8"
- P** MINI Male, 7/8" Internal Thread
- Q** RJ45

CONNECTOR STYLE, END 2

- O** Unterminated / Cut End
- R** Straight
- W** Right Angle (90°)
- C** Receptacle

CABLE TYPE

- (Unshielded unless noted)
- mPPE Insulation, ZH-PUR Jacket, 22 AWG (AWM 21959)**
- 100** 3 Conductor
 - 101** 4 Conductor
 - 102** 5 Conductor
 - 123** 8 Conductor
- SR-PVC Insulation, -40°C PVC Jacket, 18 AWG (AWM 2661)**
- 103** 8 Conductor
 - 104** 3 Conductor
 - 105** 4 Conductor
 - 106** 5 Conductor
- SR-PVC Insulation, TPE Jacket, 18 AWG (PLTC, AWM 20327)**
- 107** 3 Conductor
 - 108** 3 Conductor
 - 109** 5 Conductor
 - 112** 8 Conductor, 22 AWG
- PVC/Nylon Insulation, TPE Jacket, 16 AWG (TC-ER)**
- 113** 3 Conductor, 16 AWG
 - 114** 4 Conductor, 16 AWG
 - 115** 5 Conductor
- PO Insulation, TPE Jacket, 24 AWG (CMR, CMG)**
- 117** 4 Conductor
 - 118** 4 Conductor, Foil/Braid Shield
- PP Insulation, ZH-PUR Jacket, 24 AWG (AWM 20549/21198)**
- 124** 8 Conductor
 - 125** 12 Conductor
 - 126** 12 Conductor, Composite
 - 127** 19 Conductor, Composite
- SR-PVC Insulation, PVC Jacket, 24 AWG**
- 128** 8 Conductor, Foil/Braid Shield

Flexible Cordsets

M8 Connectors



Widely used in industrial automation and factory floor applications, M8 connectors provide a compact size that enables cleaner cable management.

EcoFlex® PUR Cable: mPPE Insulation, Slate Zero-Halogen Polyurethane Jacket

22 AWG (26/36) Bare Copper Conductors

AWM 21959 • UL Sun Res • 60C Oil Res

IP67, IP68/NEMA 6P Protection • -50°C to +90°C • 600 V

Bend Radius: 4x Static, 5x Dynamic • 5 Million Flex Life Cycles



Configuration		Part Number	
End 1	End 2	3 Poles	4 Poles
Female	Cut	GR0300100	GR0400101
Female, 90°	Cut	GW0300100	GW0400101
Male	Cut	HR0300100	HR0400101
Female	Male	GR03HR100	GR04HR101
Male	Female, 90°	HR03GW100	HR04GW101

Standard Lengths: 0.6, 1, 3, 5, 10, 15, and 20 m

M8-to-M12 Cordsets

EcoFlex® PUR Cable: mPPE Insulation, Slate Zero-Halogen Polyurethane Jacket

22 AWG (26/36) Bare Copper Conductors

AWM 21959 • UL Sun Res • 60C Oil Res

IP67, IP68/NEMA 6P Protection • -50°C to +90°C • 600 V

Bend Radius: 4x Static, 5x Dynamic • 5 Million Flex Life Cycles

Configuration		Part Number	
M12 End	M8 End	3 Poles	4 Poles
Male	Female	DR03GR100	DR04GR101
Male	Female, 90°	DR03GW100	DR04GW101

Flexible Cordsets

M12 Connector



Our M12 cordsets handle flex applications up to 5 million flex life cycles. They are available in 300 V and 600 V versions with a range of materials to meet your application conditions.

mPPE Insulation, Slate Zero-Halogen Polyurethane Jacket

22 AWG (26/36) Bare Copper Conductors

AWM 21959 • UL Sun Res • 60C Oil Res

IP67, IP68/NEMA 6P Protection • -40°C to +105°C • 600 V

Bend Radius: 4x Static, 5x Dynamic • 5 Million Flex Life Cycles

Configuration		Part Number				
End 1	End 2	3 Poles	4 Poles	5 Poles	8 Poles	8 Poles (24 AWG)
Female	Cut	AR0300100	AR0400101	AR0500102	AR0800123	AR0800103
Female, 90°	Cut	AW0300100	AW0400101	AW0500102	AW0800123	AW0800103
Male	Cut	DR0300100	DR0400101	DR0500102	DR0800123	DR0800103
Male	Female	DR03AR100	DR04AR101	DR05AR102	DR08AR123	DR08AR103
Male	Female, 90°	DR03AW100	DR04AW101	DR05AW102	DR08AW123	DR08AW103

Standard Lengths: 0.6, 1, 3, 5, 10, 15, and 20 m

SR-PVC Insulation, -40°C Slate PVC Jacket

22 AWG (26/36) Bare Copper Conductors

AWM 21959 • UL Sun Res • 60C Oil Res

IP67, IP68/NEMA 6P Protection • -40°C to +105°C • 300 V

Bend Radius: 7x Static, 10x Dynamic • 5 Million Flex Life Cycles

Configuration		Part Number			
End 1	End 2	3 Poles	4 Poles	5 Poles	8 Poles (24 AWG)
Female	Cut	AR0300104	AR0400105	AR0500106	AR0800103
Female, 90°	Cut	AW0300104	AW0400105	AW0500106	AW0800103
Male	Cut	DR0300104	DR0400105	DR0500106	DR0800103
Male	Female	DR03AR104	DR04AR105	DR05AR106	DR08AR103
Male	Female, 90°	DR03AW104	DR04AW105	DR05AW106	DR08AW103

Standard Lengths: 0.6, 1, 3, 5, 10, 15, and 20 m

SR-PVC Insulation, Slate TPE Jacket

18 AWG (41/34) Bare Copper Conductors

PLTC • AWM 20327

IP67, IP68/NEMA 6P Protection • -40°C to +105°C • 300 V

Bend Radius: 7x Static, 10x Dynamic • 5 Million Flex Life Cycles

Configuration		Part Number
End 1	End 2	8 Poles
Female	Cut	AR0800112
Female, 90°	Cut	AW0800112
Male	Cut	DR0800112
Male	Female	DR08AR112

Standard Lengths: 0.6, 1, 3, 5, 10, 15, and 20 m

Flexible Cordsets

M12 Connector



Polypropylene Insulation, Slate Zero-Halogen PUR Jacket

22 AWG (19/36) Tinned Copper Conductors • Braid Shield, 85% Coverage
AWM 20549/21198 • 300 V

Bend Radius: 5x Static, 10x Dynamic • 2 Million Flex Life Cycles

Configuration		Part Number	
End 1	End 2	8 Poles	12 Poles
Female	Cut	AR0800124	AR1200125
Female, 90°	Cut	AW0800124	AW1200125
Male, Internal Threads	Cut	DR0800124	—
Male, Internal Threads	Female	DR08AR124	—

Standard Lengths: 0.6, 1, 3, 5, 10, 15, and 20 m

SR-PVC Insulation, Slate PVC Jacket, Foil + Braid Shield

24 AWG (7/32) Bare Copper Conductors

AWM 2661

IP67, IP68/NEMA 6P Protection • -40°C to +105°C • 300 V

Bend Radius: 8x

Configuration		Part Number
End 1	End 2	8 Poles
Female	Cut	AR0800128
Male, Internal Threads	Cut	DR0800128
Male, Internal Threads	Female	DR08AR128

Standard Lengths: 0.6, 1, 3, 5, 10, 15, and 20 m

Flexible Cordsets

MINI 7/8" Connectors



MINI 7/8" connectors are an industry-standard midpower connectors used for sensor and actuator connection in harsh industrial environments. Easily identified by the yellow color, the connectors are widely used with well-established protocols such as PROFIBUS. Our 7/8" cable assemblies are available in both 300 V PLTC and 600 V TC-ER versions in a variety of configurations. Cables use finely stranded conductors to help achieve 5 million flex life cycles.

SR-PVC Insulation, TPE Jacket

18 AWG Stranded (41/34) Bare Copper Conductors
PLTC, AWM 20327

IP67, IP68/NEMA 6P Protection

-45°C to +80°C • 300 V

Bend Radius: 7x Static, 10x Dynamic • 5 Million Flex Life Cycles

Configuration		Part Number		
End 1	End 2	3 Poles	4 Poles	5 Poles
Female	Cut	KR0300107	KR0400108	KR0500109
Female, 90°	Cut	KW0300107	KW0400108	KW0500109
Male	Cut	LR0300107	LR0400108	LR0500109
Male	Female	LR03KR107	LR04KR108	LR05KR109
Male	Female, 90°	LR03KW107	LR04KW108	LR05KW109

Standard Lengths: 0.6, 1, 3, 5, 10, 15, and 20 m



PVC/Nylon Insulation, TPE Jacket

16 AWG (65/34) Bare Copper
TC-ER • UL Sun Res • UL Oil Res I/II

IP67, IP68/NEMA 6P Protection • -40°C to +105°C • 600 V

Bend Radius: 7x Static, 10x Dynamic • 5 Million Flex Life Cycles

Configuration		Part Number		
End 1	End 2	3 Poles	4 Poles	5 Poles
Female	Cut	KR0300113	KR0400114	KR0500115
Female, 90°	Cut	KW0300113	KW0400114	KW0500115
Male	Cut	LR0300113	LR0400114	LR0500115
Male	Female	LR03KR113	LR04KR114	LR05KR115
Male	Female, 90°	LR03KW113	LR04KW114	LR05KW115
Male, Internal Thread	Cut	PR0300113	PR0400114	PR0500115
Male, Internal Thread	Female	PR03KR113	PR04KR114	PR05KR115
Male, Internal Thread	Female, 90°	PR03KW113	PR04KW114	PR05KW115

Standard Lengths: 0.6, 1, 3, 5, 10, 15, and 20 m



Our Industrial Ethernet cables use D-Code M12 or RJ45 connectors and a 2-pair construction. They meet Cat 5e applications to support data rates up to 1 Gb/s. Choose between unshielded for smallest diameter or foil/braid shielding for signal integrity in noisy environments.

M12 Ethernet Cordsets

PO Insulation, Teal TPE Jacket

24 AWG (7/32) Tinned Copper Conductors

Unshielded: CMR, CMG • Shielded: AWM 20626

IP67, IP68/NEMA 6P Protection • -40°C to +75°C • 300 V

Bend Radius: 9x Unshielded, 11x Shielded • 5 Million Flex Life Cycles

Configuration		Part Number	
End 1	End 2	4 Poles, Unshielded	4 Poles, Foil + Braid
Male	Female	DR04AR117	—
Male	Male	DR04DR117	DR04DR118
Female	Female	AR04AR117	—
Male, 90°	Female	DW04AR117	—
Male, 90°	Male	DW04DR117	—
Male, 90°	Male, 90°	DW04DW117	—

Standard Lengths: 0.6, 1, 3, 5, 10, 15, and 20 m



RJ45 Connectors and M12 to RJ45

PO Insulation, Teal TPE Jacket

24 AWG (7/32) Tinned Copper Conductors

Unshielded: CMR, CMG • Shielded: AWM 20626

IP67, IP68/NEMA 6P Protection • -40°C to +75°C • 300 V

Bend Radius: 9x Unshielded, 11x Shielded • 5 Million Flex Life Cycles

Configuration		Part Number	
End 1	End 2	Unshielded	Foil + Braid Shield
RJ45	RJ45	QR04QR117	QR04QR118
M12, Male	RJ45	DR04QR117	DR04QR118
RJ45	M12, Female	QR04AC117	QR04AC118
M12, Male, 90°	RJ45	DW04QR117	—

Standard Lengths: 0.6, 1, 3, 5, 10, 15, and 20 m



Cordsets

M23 Connectors



M23 cordsets are designed for use with our connectorized distribution boxes as a homerun cable, or for power applications on the plant floor. The cables are used to connect distribution boxes to the PLC or other control device.

PP Insulation, Black Zero-Halogen Polyurethane Jacket
Composite 20 AWG (65/38) and 17 AWG (210/40) Conductors
AWM 20549
IP67, IP68/NEMA 6P Protection • -40°C to +80°C • 300 V
Bend Radius: 5x Static, 10x Dynamic

Configuration		Part Number	
End 1	End 2	12 Poles	19 Poles
Female	Cut	ER1200126	ER1900127
Female, 90°	Cut	EW1200126	EW1900127
Male	Cut	FR1200126	FR1900127
Male, 90°	Female, 90°	FW12EW126	FW19EW127

Standard Lengths: 5, 10, 15, and 20 m

Bulk Cable

Multiconductor Cable

Insulation	Jacket	Wire Size (Shielding)	No. of Conductors	Part No.
Unshielded Cable				
mPPE	ZH-PUR	22 AWG (26/36) BC	3	100
			4	101
			5	102
			8	123
SR-PVC	TPE	18 AWG (41/34) BC	8	112
			3	107
			4	108
			5	109
PVC/Nylon	TPE	16 AWG (65/34) BC	3	113
			4	114
			5	115
PP	ZH-PUR	20 AWG (65/38) BC 17 AWG (210/40) BC	8 (20 AWG) / 3 (17 AWG)	126
			16 (20 AWG) / 3 (17 AWG)	127
			24 AWG (19/36) BC	103
SR-PVC	-40°C Premium PVC	22 AWG (26/36) BC	3	104
			4	105
			5	106
Braid Shielded Cable				
PP	ZH-PUR	24 AWG (19/36) BC	8	124
			12	125
Foil + Braid Shielded Cable				
SR-PVC	-40°C Premium PVC	24 AWG (7/32) BC	8	128

Ethernet Twisted-Pair Cable

Cat 5e, 2 Pair

Cable Type:	Part No.	
	Unshielded	Foil + Braid
PO Insulation / TPE Jacket 24 AWG (7/32) TC conductors	117	118

M12 Distribution Boxes

Thermoplastic Housings for Industrial Use



Configuration

Ports: 4, 6, or 8 M12 receptacles
Signals per Port: 1 or 2
Control Cable: Black PVC
Control Connector: M23

Materials

Housing: Thermoplastic polyurethane, flame retardant
Insert: Glass-filled polyamide, flame retardant
Contacts: Copper zinc, plated gold over nickel
Receptacle Shell: Copper zinc, nickel plated
O-Ring: FKM fluoroelastomer

Environmental

Sealing: IP67/NEMA 6P
Temperature Range: -15°C to +80°C

Electrical

Contact Resistance: 5 mΩ max.
Voltage Rating:
 Without LEDs: 30 VDC
 With LED: 10 to 30 VDC
Current Rating: 4 A Per Port / 12 A total

Accessories (Included)

Dust Covers
 Attachable Labels



Ports	Signals/Ports	LEDs	Part Number		
			Connectorized	5 m Cable	10 m Cable
4	1	Yes	916-CN	916-5M	916-10M
		No	—	917-5M	917-10M
	2	Yes	918-CN	918-5M	918-10M
		No	919-CN	919-5M	919-10M
6	1	Yes	912-CN	912-5M	912-10M
		No	913-CN	913-5M	913-10M
	2	Yes	914-CN	914-5M	914-10M
		No	915-CN	915-5M	915-10M
8	1	Yes	908-CN	908-5M	908-10M
		No	909-CN	909-5M	909-10M
	2	Yes	910-CN	910-5M	910-10M
		No	911-CN	911-5M	911-10M

Note: LEDs are wired for use with pNp sensors.

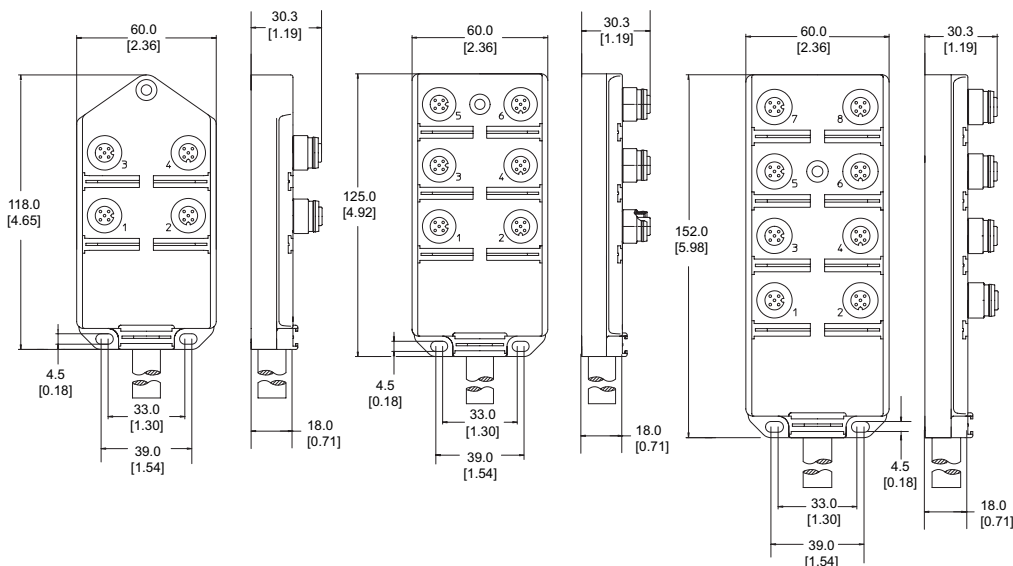

4 Ports
 916, 917, 918, 919 Series

6 Ports
 912, 913, 914, 915 Series

8 Ports
 908, 909, 910, 911 Series

M12 Distribution Boxes

Die-Cast Housings for Increased Ruggedness



Configuration

Ports: 4-pole M12 receptacles

Signals per Port: 1 or 2

Control Cable: Black PVC

Control Connector:

12-pole M23 receptacle

Materials

Housing: Die-Cast zinc

Potting: 2K polyurethane

Insert:

M12: Glass-filled polyamide

M23: PBT

Contacts: Copper zinc, plated gold over nickel

Environmental

Sealing: IP65/67

Temperature Range: -40°C to +80°C (UL: 60°C max.)

Dynamic Applications -25°C to +60°C

Electrical

Contact Resistance: 5 mΩ max.

Voltage Rating: 10 to 30 VDC

Current Rating: 4 A per port / 12 A total

Accessories (Included)

Dust Covers

Attachable Labels

Ports	Signals/Ports	LEDs	Part Number		
			Connectorized	5 m Cable	10 m Cable
4	1	Yes	904-CN	904-5M	904-10M
		No	905-CN	905-5M	905-10M
	2	Yes	906-CN	906-5M	906-10M
		No	907-CN	907-5M	907-10M
8	1	Yes	900-CN	900-5M	900-10M
		No	901-CN	901-5M	901-10M
	2	Yes	902-CN	902-5M	902-10M
		No	903-CN	903-5M	903-10M

Note: LEDs are wired for use with pNp sensors.

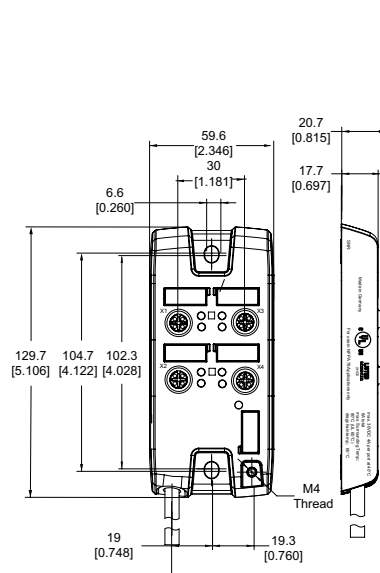

4 Ports

904, 905, 906, 907 Series

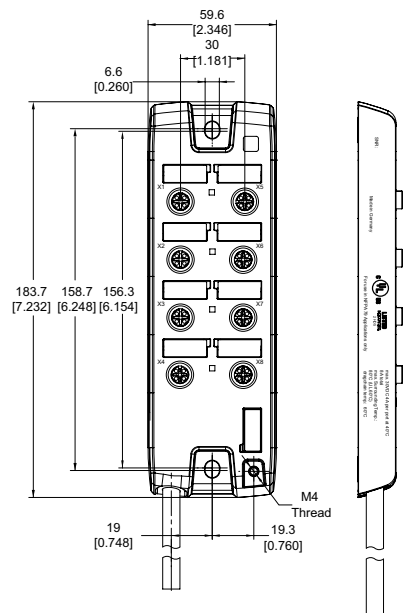

8 Ports

908, 909, 910, 911 Series

M12 Distribution Boxes

Stainless Steel Housings for Food/Beverage and Medical Applications



Configuration

Ports: 8 M12 receptacles
Signals per Port: 1
Control Cable: Black PVC

Materials

Housing: Stainless steel, 360
Contact Insert: PVC
Contacts: Copper zinc, plated gold over nickel

Mechanical/Environmental

Sealing: IP67/IP69K
Temperature Range: -25°C to +70°C

Electrical

Rated Voltage: 10 to 30 VDC
Rated Current:
 4 A per port
 12 A total

Accessories (Included)

M12 Dust Covers
 Attachable Labels



Ports	Signals/Ports	LEDs	Part Number	
			20 m Cable	10 m Cable
8	1	Yes	920-20M	920-10M

Note: LEDs are wired for use with pNp sensors.

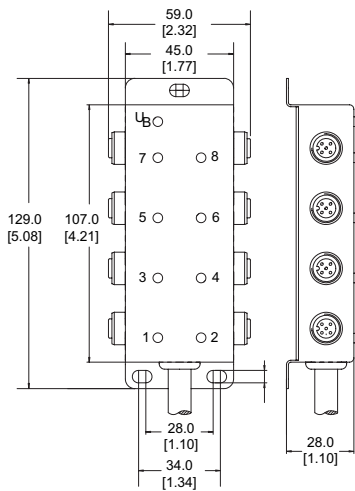

8 Ports
 920 Series

M8 Distribution Boxes

Thermoplastic Housings for Industrial Use



Configuration

Ports: 3-pole M8 receptacles

Signals per Port: 1

Control Cable: Black halogen-free polyurethane

Control Connector: 12-pole M12 receptacle

Materials

Housing: Thermoplastic polyurethane, flame retardant

Insert: Glass-filled polyamide, flame retardant

Contacts: Copper zinc, plated gold over nickel

Environmental

Sealing: IP67/NEMA 6P

Temperature Range: -15°C to +80°C

Electrical

Voltage Rating:

With LED: 10 to 30 VDC

Current Rating: 4 A per port / 12 A total

Accessories (Included)

Dust Covers

Attachable Labels

Ports	Signals/Ports	LEDs	Part Number		
			Connectorized	5 m Cable	10 m Cable
4	1	Yes	802-CN	802-5M	802-10M
6	1	Yes	803-CN	803-5M	803-10M
8	1	Yes	804-CN	804-5M	804-10M
10	1	Yes	800-CN	800-5M	800-10M
12	1	Yes	—	801-5M	801-10M

Note: LEDs are wired for use with pNp sensors.

M8 Distribution Boxes

Thermoplastic Housings for Industrial Use

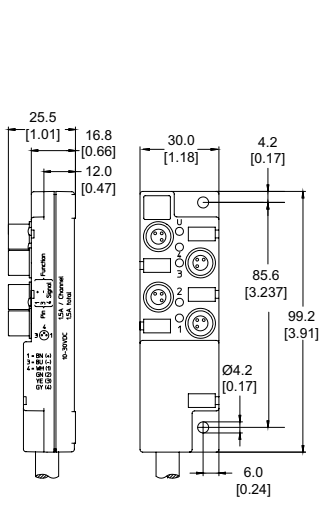

4 Ports
802, 806 Series

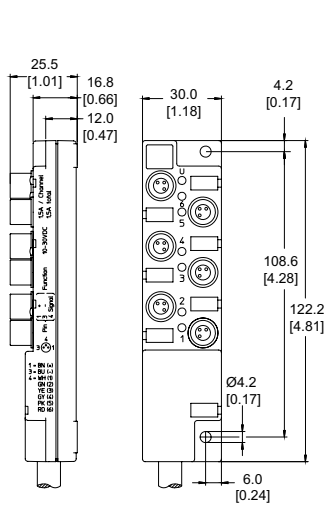

6 Ports
803 Series

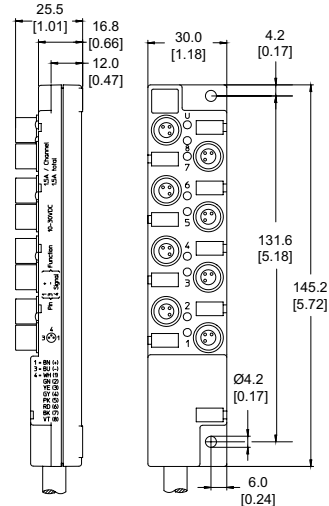

8 Ports
804, 805 Series

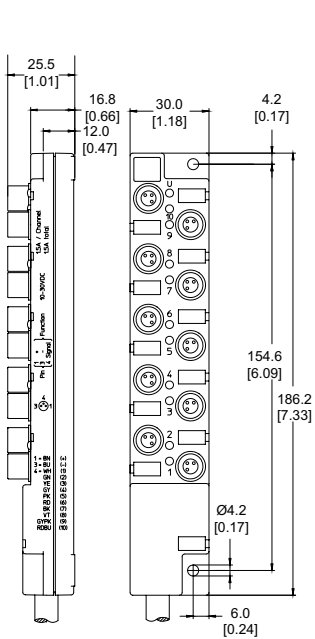

10 Ports
800 Series

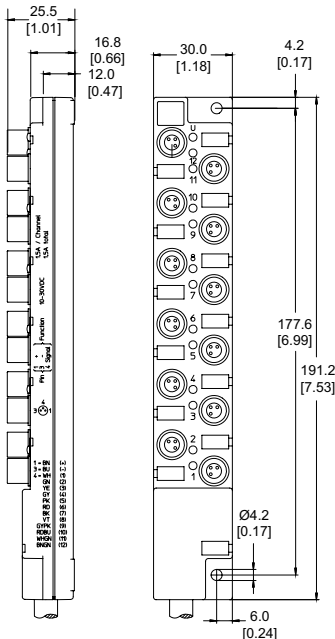

12 Ports
801 Series

Field Attachable Connectors



M8 Connectors

Style	Poles	Part Number
		0.138 - 0.197 Cable Dia.
Female	3	210GR
	4	211GR
Male	3	214HR
	4	215HR
Male, Solder Cup	3	212HR
	4	213HR

M12 Connectors

Coupling Nut	Poles	Part Number		
		0.118 - 0.256 Cable Dia.	0.158 - 0.315 Cable Dia.	2 x 0.118 - 0.256 Cable Dia.
Thermoplastic				
Female	4	202AR7	202AR9	—
	5	203AR7	203AR9	—
Female, 90°	4	204AW7	204AW9	—
	5	206DR7	206DR7	—
Male	4	206DR7	206DR9	206DR2
	5	207DR7	207DR9	207DR2
Male, 90°	4	208DW7	—	—
	5	209DW7	—	—
Stainless Steel				
Female	4	200ARS7	—	—
Male	4	201DRS7	—	—



MINI 7/8" Connectors

Style	Poles	Part Number			
		0.236 - 0.315 Cable Dia.	0.315 - 0.394 Cable Dia.	0.394 - 0.472 Cable Dia.	0.472 - 0.551 Cable Dia.
Female	3	216KR9	216KR11	216KR13	216KR16
	4	217KR9	217KR11	217KR13	217KR16
	5	218KR9	218KR11	218KR13	218KR16
Male, External Threads	3	219LR9	219LR11	219LR13	219LR16
	4	220LR9	220LR11	220LR13	220LR16
	5	221LR9	221LR11	221LR13	221LR16
Male, Internal Threads	3	222PR9	—	222PR13	222PR16
	4	223PR9	223PR11	223PR13	223PR16
	5	224PR9	224PR11	224PR13	224PR16

Receptacle Connectors



M8 Connectors, with 0.5 m Flying Leads

Style	Poles	Color Code	Part Number
			Front Mount
PG7 Mounting Holes			
Female	3	IEC	310GCF
	4	IEC	312GCF
Male	3	IEC	311HCF
	4	IEC	313HCF

M12 Connectors, with 0.5 m Flying Leads

Style	Poles	Color Code	Part Number	
			Rear Mount	Front Mount
Thermoplastic: PG9 Mounting Holes				
Female	4	IEC	301ACR	301ACF
	5	U.S.		303DCF
	5	IEC	304ACR	304ACF
Male	4	IEC	300DCR	300DCF
	5	IEC	302DCR	302DCF
Thermoplastic: 1/2 NPT				
Female	4	IEC		301ACN
	5	IEC		304ACN
Male	4	IEC		300DCN
	5	IEC		302DCN
Stainless Steel: M16 Mounting Holes				
Female	4	IEC		306ACFS
	5	IEC		309ACFS
Male	4	IEC		305DCFS*
	5	IEC		307DCFS*



MINI 7/8" Connectors, with 0.3, 1, or 2 m Flying Leads

Style	Poles	Color Code	Part Number
			Front Mount
Female, External Threads	3	U.S.	314JCF
	4	U.S.	316JCF
	5	U.S.	318JCF
Female, Internal Threads	3	IEC	315JCF
	4	IEC	317KCF
	5	IEC	319KCF
Male, External Threads	3	U.S.	320LCF
		IEC	321LCF
	4	U.S.	322LCF
		IEC	323LCF
	5	U.S.	324LCF
		IEC	325LCF

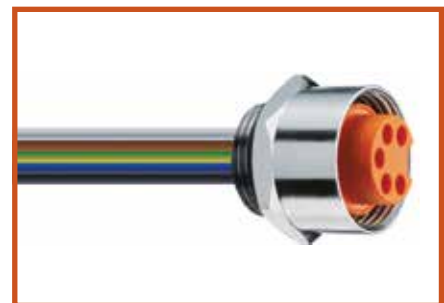



2:1 T splitters permit two cables to be connected to a single 2 signal per port distribution box.

Configuration

Ports: 1:2 Splitter

Materials

Housing: Thermoplastic polyurethane, flame retardant

Insert: Thermoplastic polyurethane, flame retardant

M12 Female: Polyamide, flame retardant

Contacts:

Copper alloy, plated gold over nickel

Coupling Nut:

Copper alloy

Environmental

Sealing: IP67/NEMA 6P

Temperature Range:

-25°C to +90°C

Electrical

Voltage Rating: 30 V

Current Rating: 4 A

Single Port	Double Ports	Body Style	Color	Part Number
M12 Male	M12 Female	Standard	Orange	SPL001 OR032
		Wide	Black	SPL001W BK032
M12 Male	M8 Female	Standard	Orange	SPL003 OR032

1:2 Splitter

M8 Connectors

Part No. SPL003 OR032

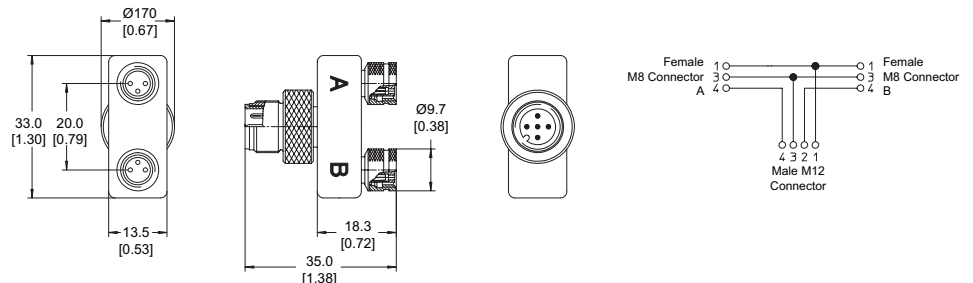

1:2 Splitter

M12 Connectors

Part No. SPL001 OR032

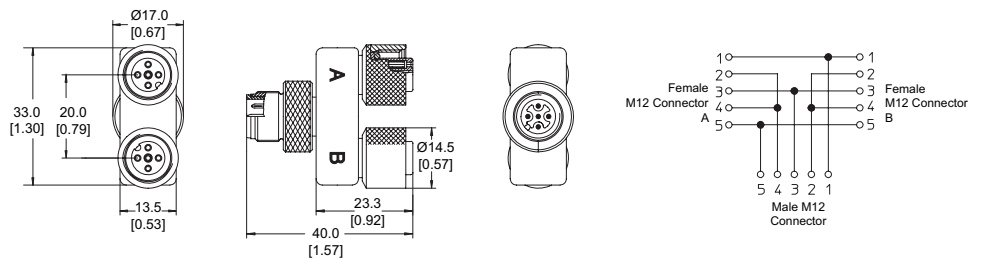

1:2 Splitter, Wide Body

M12 Connectors

Part No. SPL001W BK032

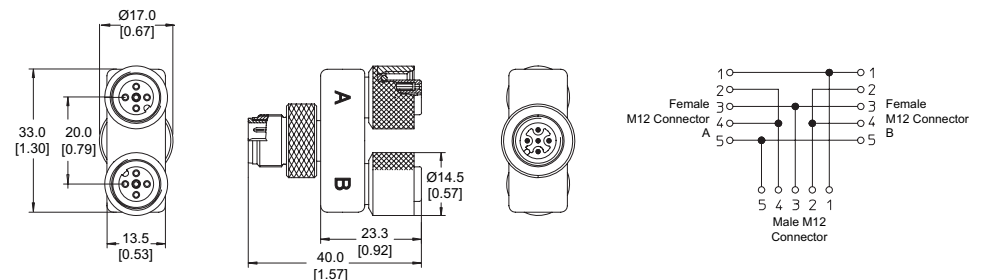

GLOBAL HEADQUARTERS
711 Lidgerwood Avenue
Elizabeth, NJ 07207-0711 USA
Toll Free: 1-800-52 ALPHA
Tel: 1-908-925-8000
Fax: 1-908-925-5411
E-mail: info@alphawire.com

EUROPE
Alpha Wire International
Saxon House
1 Downside | Sunbury-on-Thames
Middlesex | United Kingdom | TW16 6RT
Tel: +44 1 932 772 422
Fax: +44 1 932 772 433
E-mail: europe@alphawire.com

ASIA PACIFIC
Alpha Wire
Silver Center | Room 1712
North Shanxi Road 1388
Shanghai | China | 200060
Tel: + 86-21-61498201/61498205
Fax: + 86-21-61498001
E-mail: apac@alphawire.com



AlphaWire

Cables you trust. Service you deserve.