

DETAILS

Product Number	CA14442_VERONICA-SQ-W
Family	Veronica
Type	Assembly
Color	clear
Diameter	22,5x22,5 mm
Height	12,2 mm
Style	square
Optic Material	PMMA
Holder Material	
Fastening	
Status	production ready
ROHS Compliant	Yes
Date Updated	21/12/2016

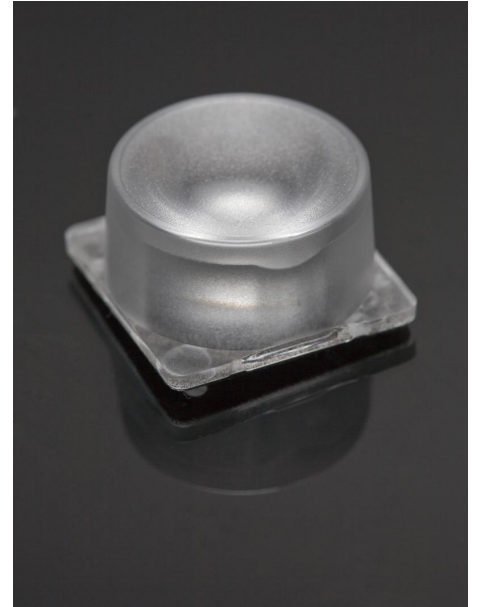

OPTICAL PROPERTIES

LED	Viewing Angle	Light Beam	Efficiency	cd/lm	Connector
XP-E2	52 deg	Wide	92 %	1.180	-
XB-H	50 deg	Wide	80 %	0.940	-
XM-L2	53 deg	Wide	80 %	0.920	-
XT-E	46 deg	Wide	80 %	1.100	-
XM-L	53 deg	Wide	81 %	0.940	-
XP-E	51 deg	Wide	81 %	0.970	-
XP-G	53 deg	Wide	81 %	0.910	-
XHP35 HD	52 deg	Wide	78 %	0.950	-
XHP35 HI	49 deg	Wide	81 %	1.100	-
H35C1 (LEMWA33)	52 deg	Wide	81 %	0.960	-
LUXEON MZ	41 deg	Wide	83 %	1.400	-
LUXEON R	48 deg	Wide	80 %	1.100	-
LUXEON T	49 deg	Wide	82 %	1.000	-
LUXEON TX	48 deg	Wide	81 %	1.000	-
LUXEON Rebel ES	46 deg	Wide	80 %	1.100	-
LUXEON A	50 deg	Wide	79 %	1.000	-
NVSxx19B/NVSxx19C	46 deg	Wide	81 %	1.110	-
NCSxx19B	45 deg	Wide	80 %	1.200	-
NWSx229A	51 deg	Wide	78 %	0.930	-
NVSW3x9A	48 deg	Wide	78 %	1.100	-
Oslon SSL 80	46 deg	Wide	80 %	1.100	-
Oslon Square PC	48 deg	Wide	79 %	1.100	-
Oslon Square EC	48 deg	Wide	80 %	1.100	-
Oslon Square Gen3	sim: 50	Wide	sim: 90 %	sim: 1.100	-
Duris P10	sim: 42	Wide	sim: 90 %	sim: 1.400	-



PRODUCT DATASHEET
Veronica series
last update 21/12/2016

OPTICAL PROPERTIES

LED	Viewing Angle	Light Beam	Effi- ciency	cd/lm	Connector
Z8Y22P	42 deg	Wide	78 %	1.200	-

Relative intensity of CA14442_VERONICA-SQ-W_(XP-E2)

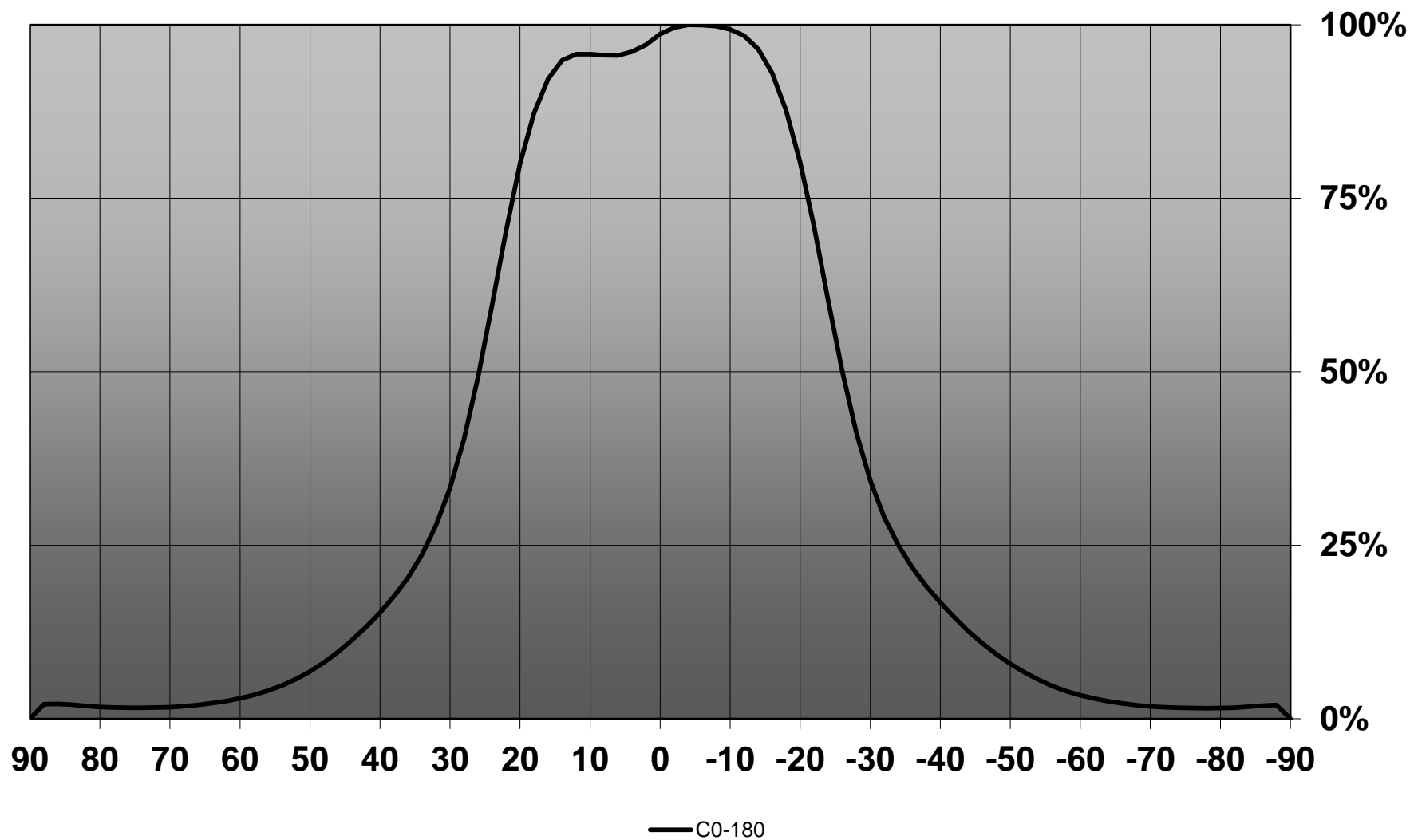

Relative intensity of CA14442_VERONICA-SQ-W_(XHP35_HD)

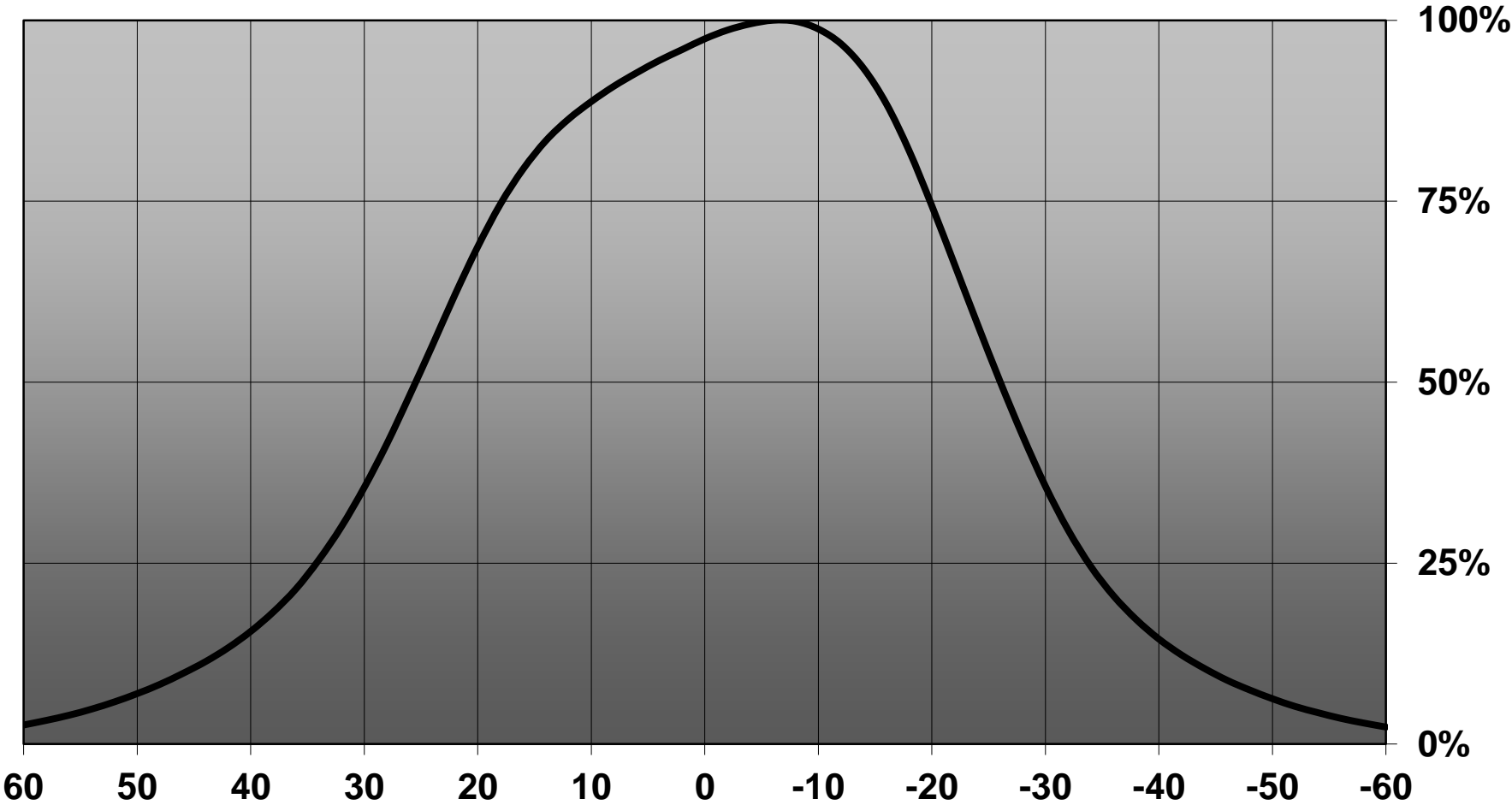

Relative intensity of CA14442_VERONICA-SQ-W_(XPH35_HI)

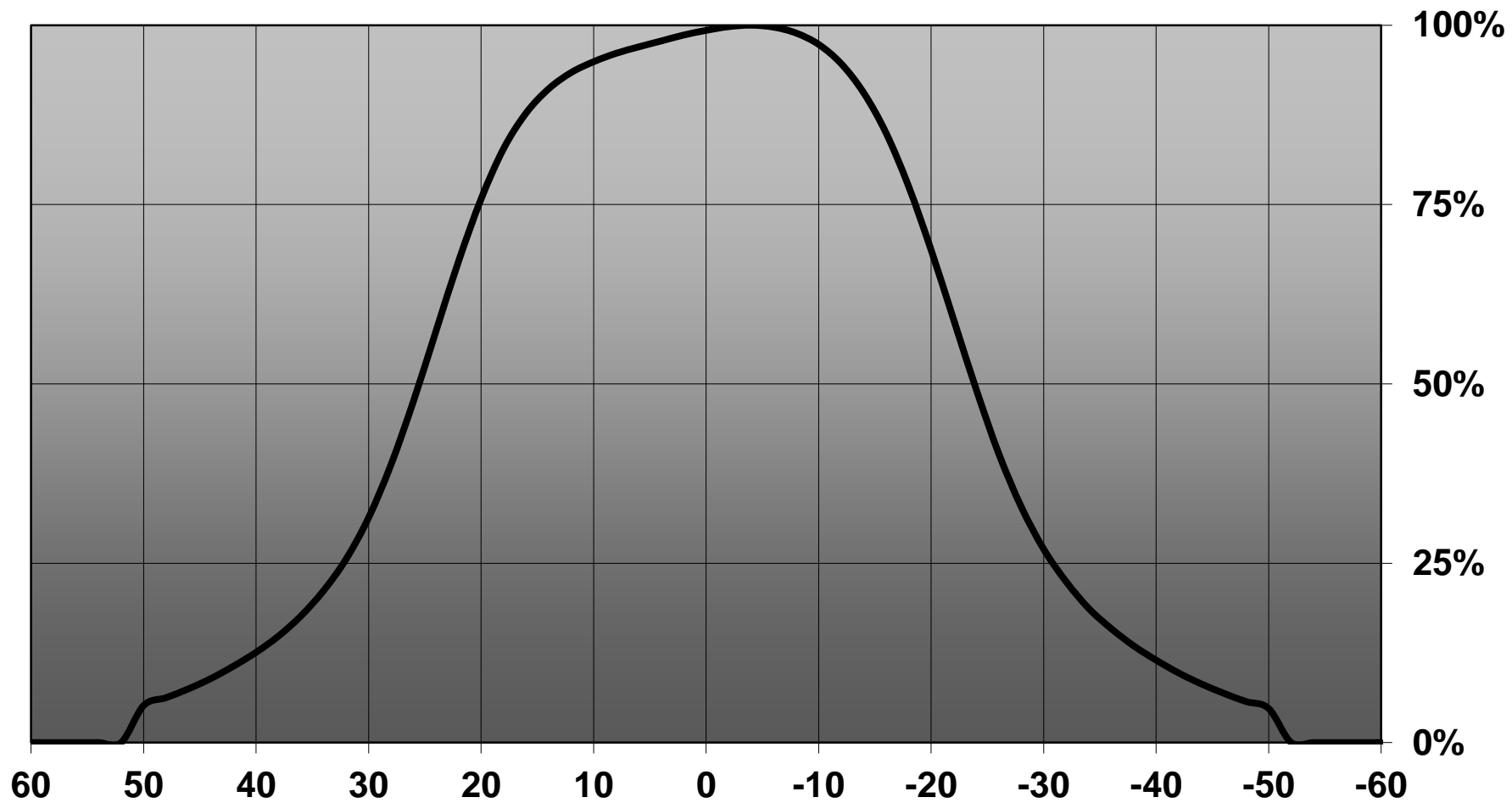

D

C

B

A

4

4

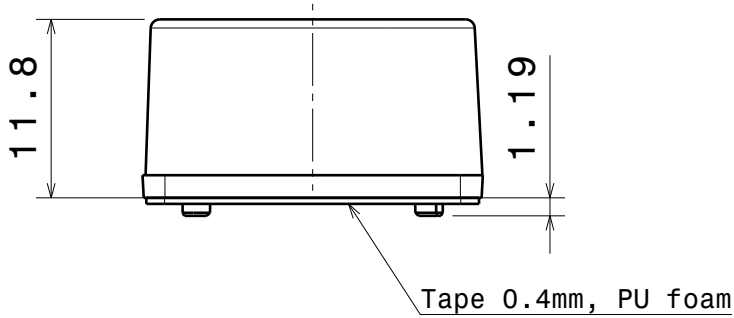

Front view

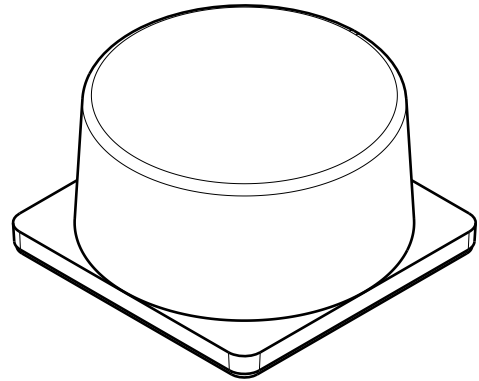

Isometric view

3

3

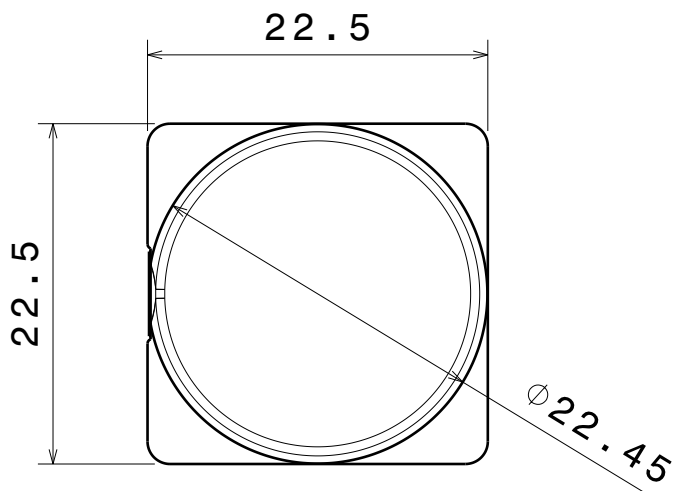

Top view

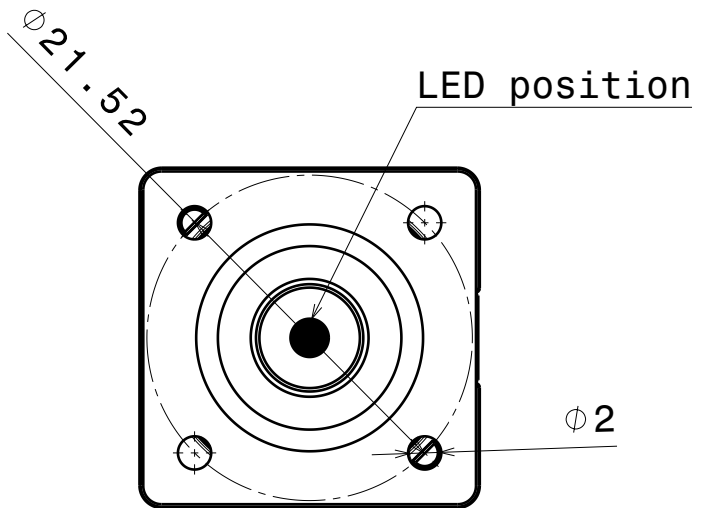

Bottom view

2

2

INDEX	PART NO	DESCRIPTION	MATERIAL	COLOUR
1	C14447	VERONICA-SQ-W	PMMA	clear

Tolerances if not otherwise shown
According to DIN ISO 2768-1
Linear measures:
Up to 30mm class M, otherwise class C
According to DIN ISO 2768-2
Form and position: class L

LEDiL

Ledil Oy
Salorankatu 10
FIN 24240 SALO
Finland

THIRD ANGLE PROJECTION:

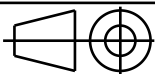

DRAWING TITLE

CA14442_VERONICA-SQ-W

This drawing is the property
of LEDiL Oy. It may not be
reproduced, copied or
communicated without a written
agreement with LEDiL Oy.

SIZE PART NUMBER

A4

CA14442

SCALE	2:1	WEIGHT	3,90 g	SHEET	1/1
-------	-----	--------	--------	-------	-----

1

1

D

A

Luminaire: LEDiL Oy CA14442_VERONICA-SQ-W_(XB-H)

Lamps: 1 x Cree_XB-H_(XBHAWT-0-7C1-T30-0H-0001)_97.2452lm@250mA_P=0.755198W_I=0.2499A

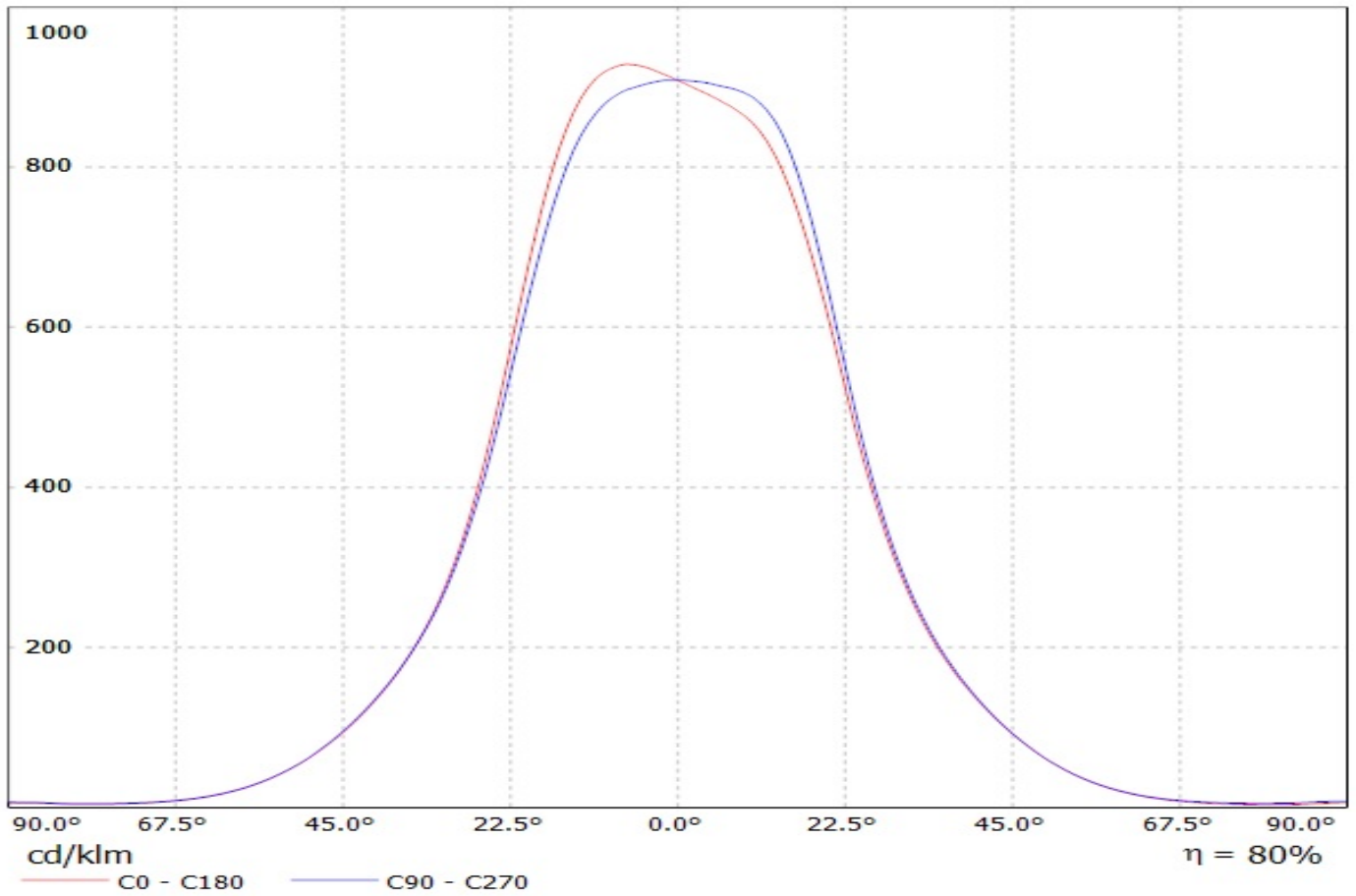

Luminaire: LEDiL Oy CA14442 VERONICA-SQ-W_(XM-L2)

Lamps: 1 x Cree_XM-L2_(XMLBWT-0-7B4-T30-0L-0001)_88.0594lm@250mA_P=0.738554W_I=0.2499A

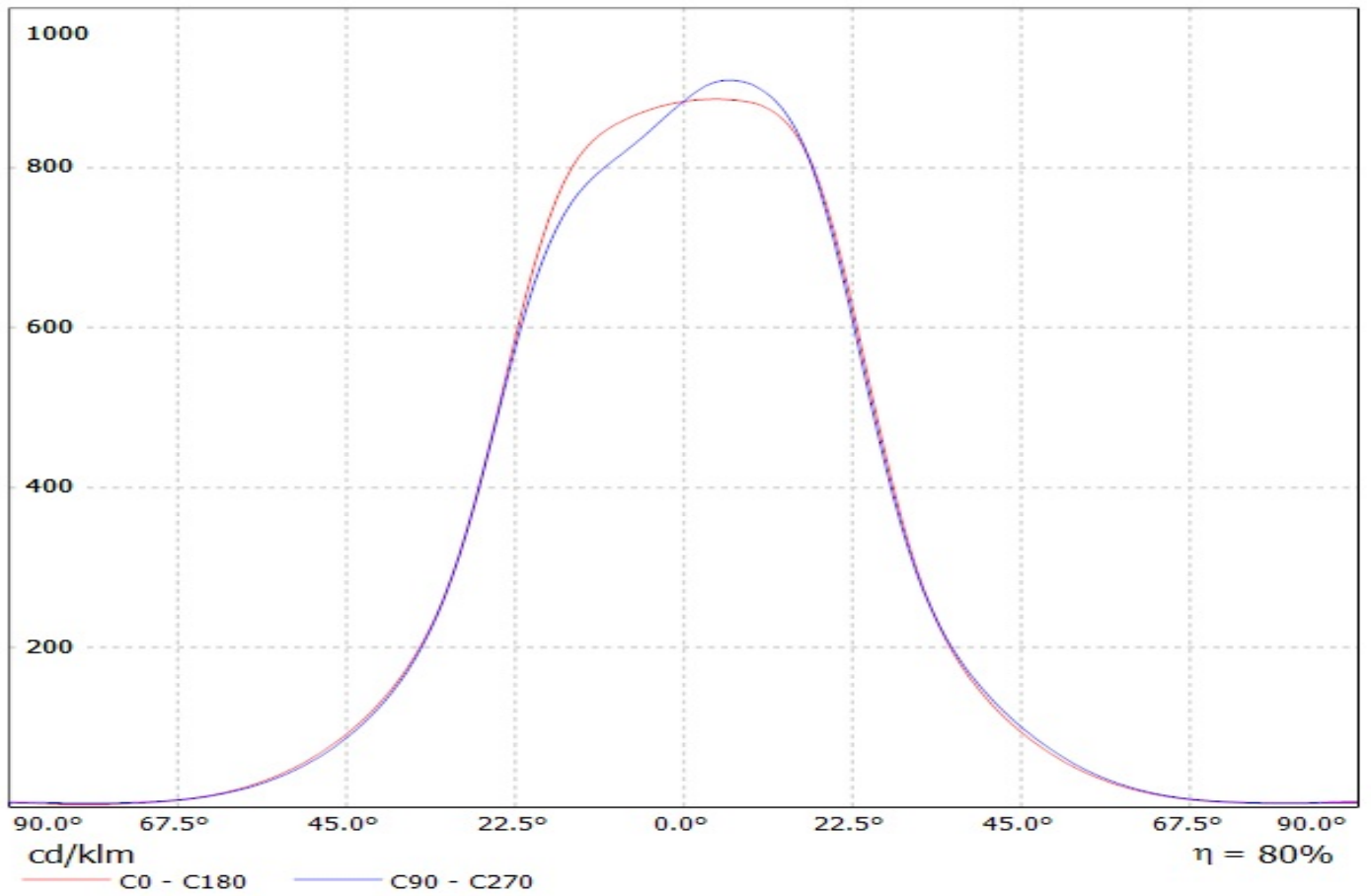

Luminaire: LEDiL Oy CA14442_VERONICA-SQ-W_(XT-E)

Lamps: 1 x Cree_XT-E_(XTEAWT-0-2A0-R30-FB-0001)_98.1299lm@250mA_CCT=5453K_P=0.781812W_I=0.2499A

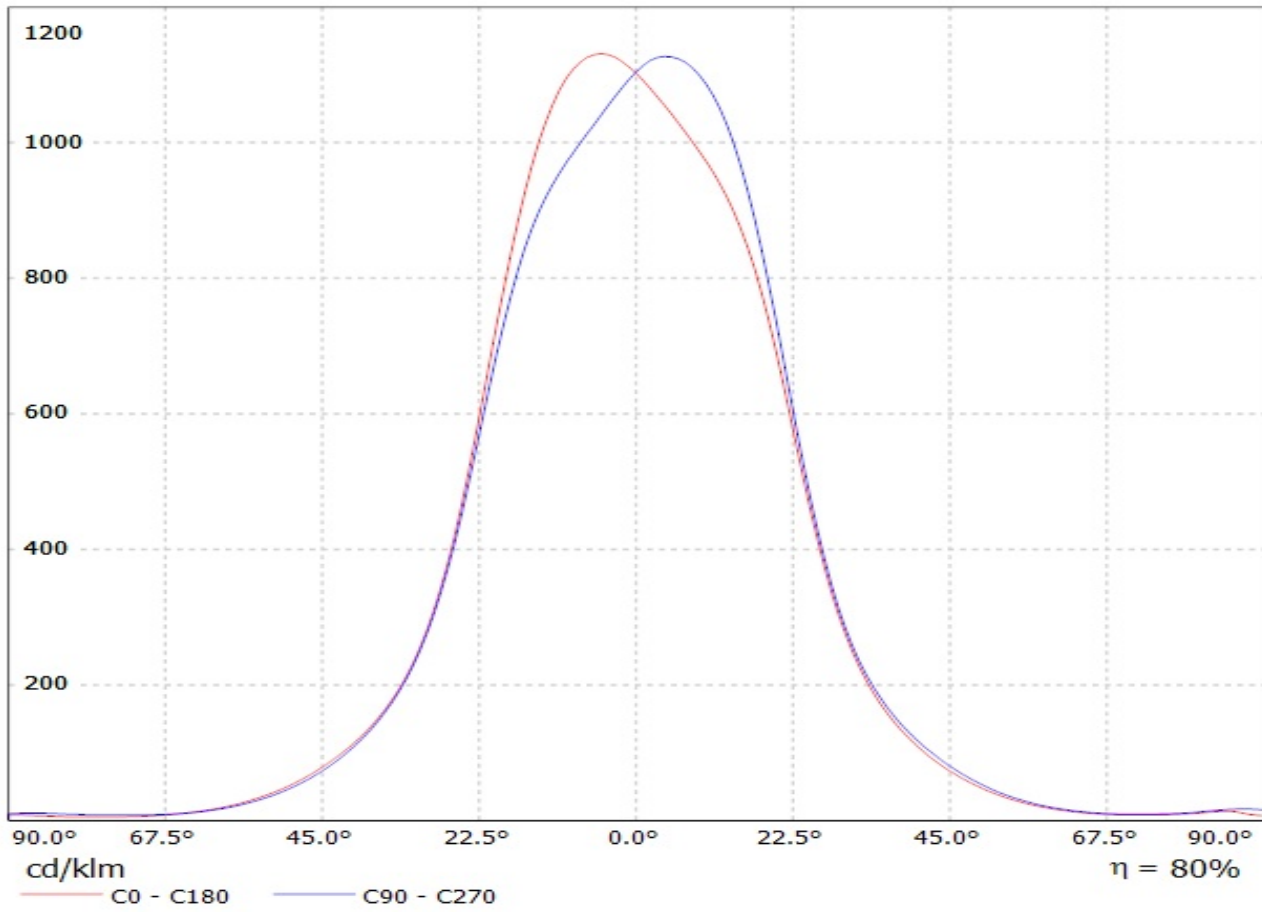

Luminaire: LEDiL Oy CA14442_VERONICA-SQ-W_(XM-L)

Lamps: 1 x Cree_XM-L_(XMLAWT-00-0000-0000T6051)_100.156lm@250mA_P=0.72556W_I=0.2499A

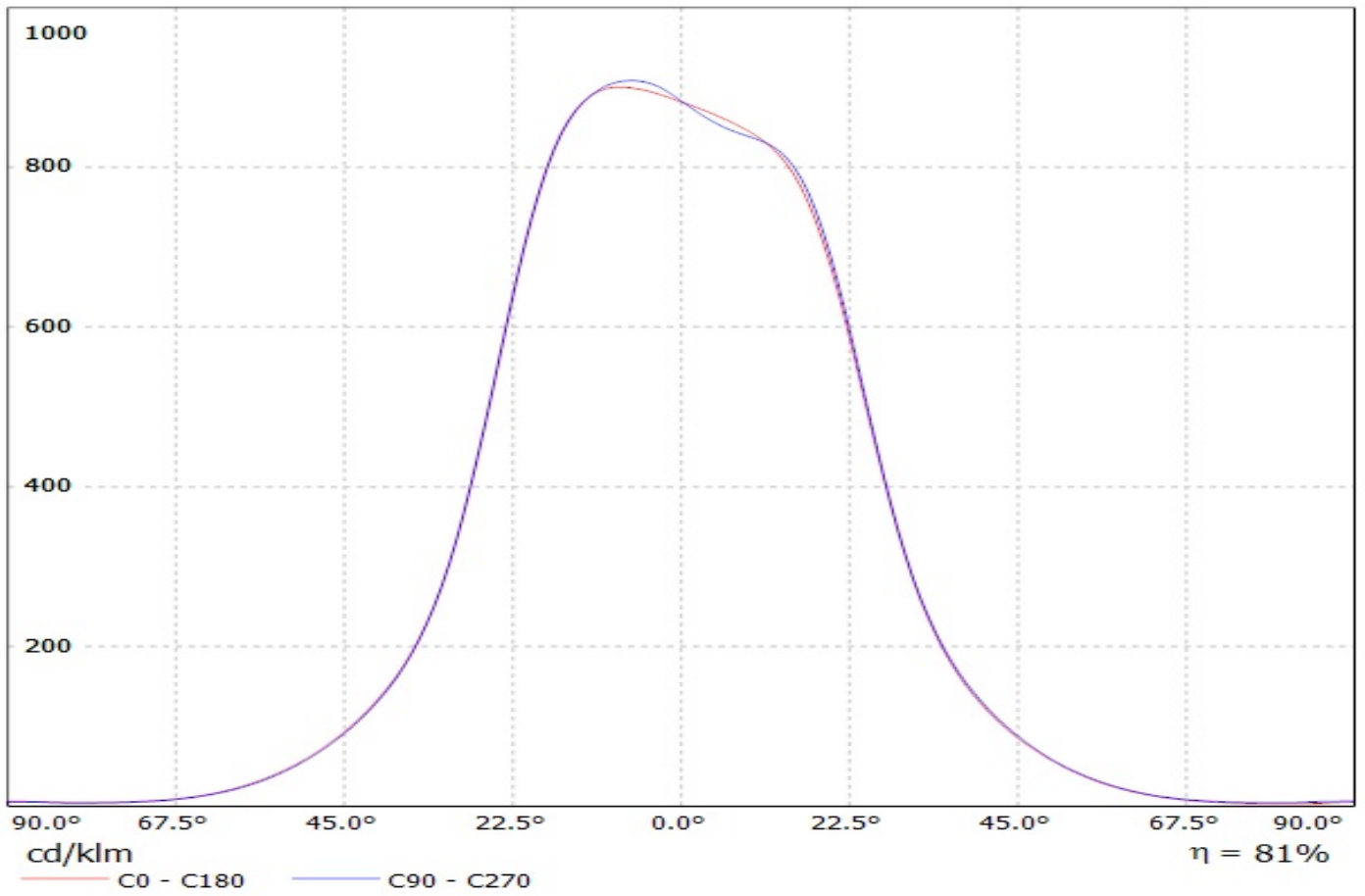

Luminaire: LEDiL Oy CA14442_VERONICA-SQ-W_(XP-E)

Lamps: 1 x Cree_XP-E_(XPEWHT-L1-3C0-Q5-0-06)_78.5375lm@250mA_P=0.803279W_I=0.2499A

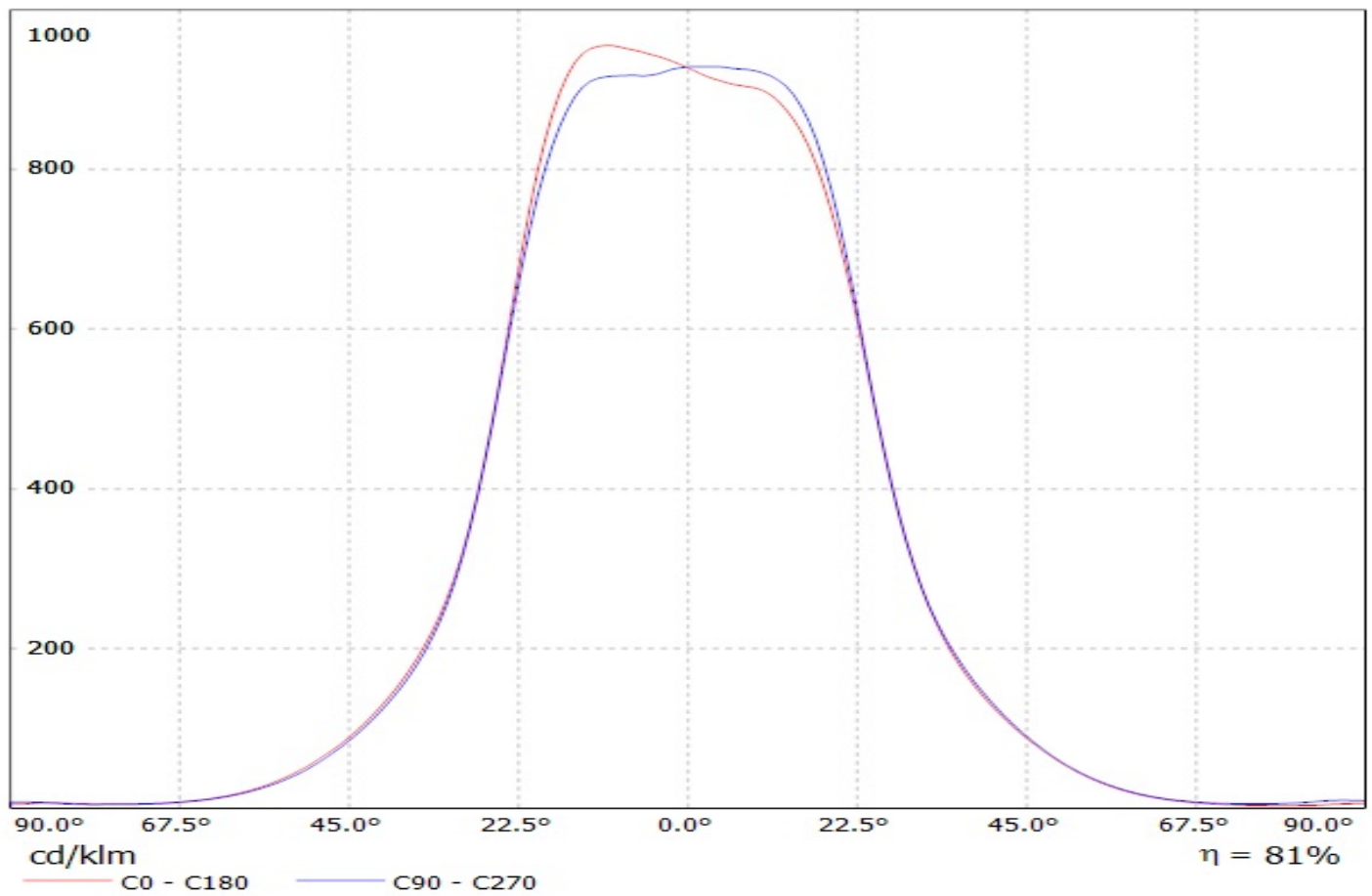

Luminaire: LEDiL Oy CA14442_VERONICA-SQ-W_(XP-G)

Lamps: 1 x Cree_XP-G_(XPGWHT-L1-CWPI-00BE7)_67.193lm@250mA_P=0.769792W_I=0.2499A

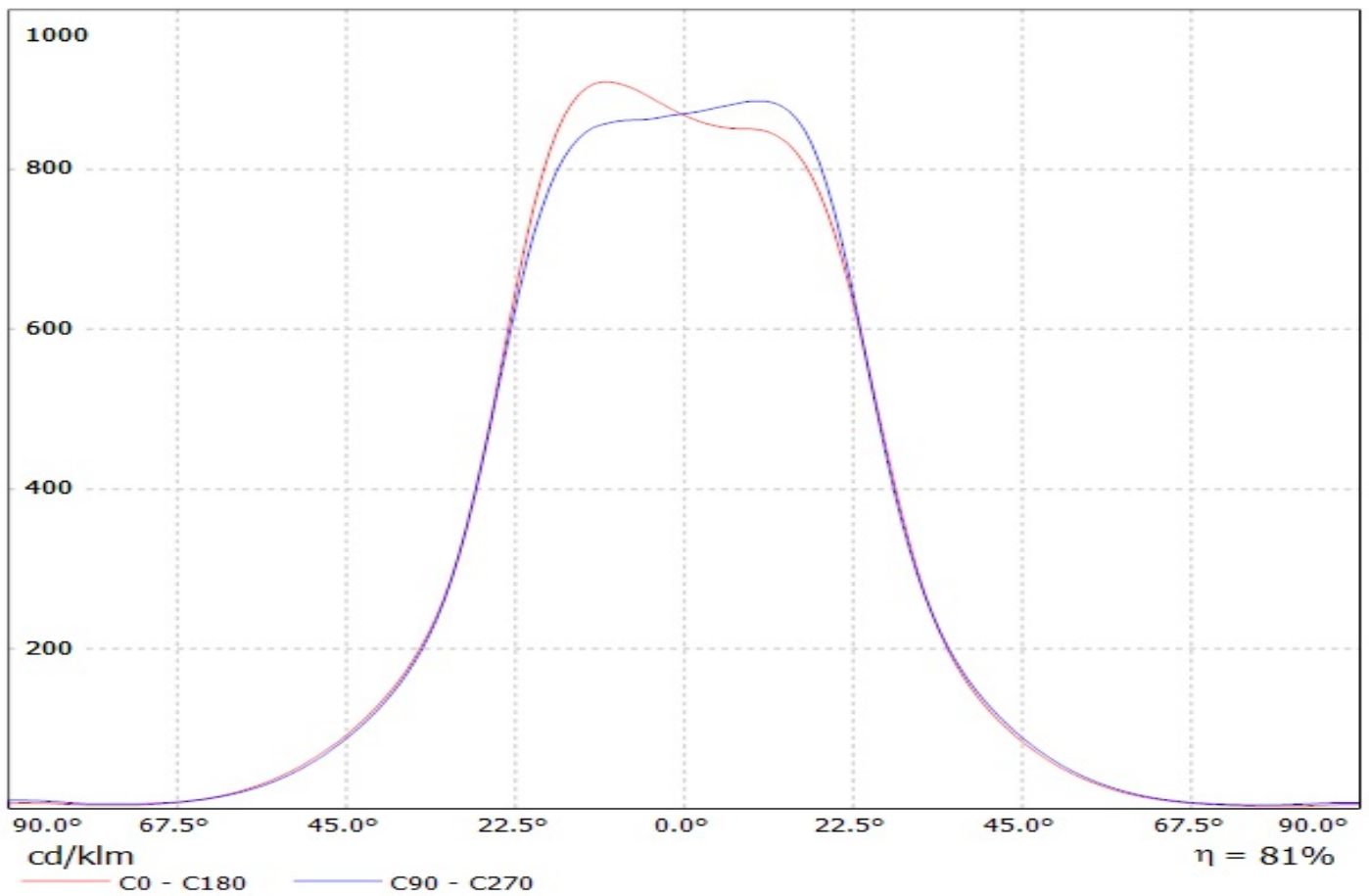

Luminaire: LEDiL Oy CA14442 VERONICA-SQ-W (H35C1)

Lamps: 1 x LG_H35C1_(PKG5700K)_116.036lm@250mA_CCT=6235K_P=0.757272W_I=0.2499A

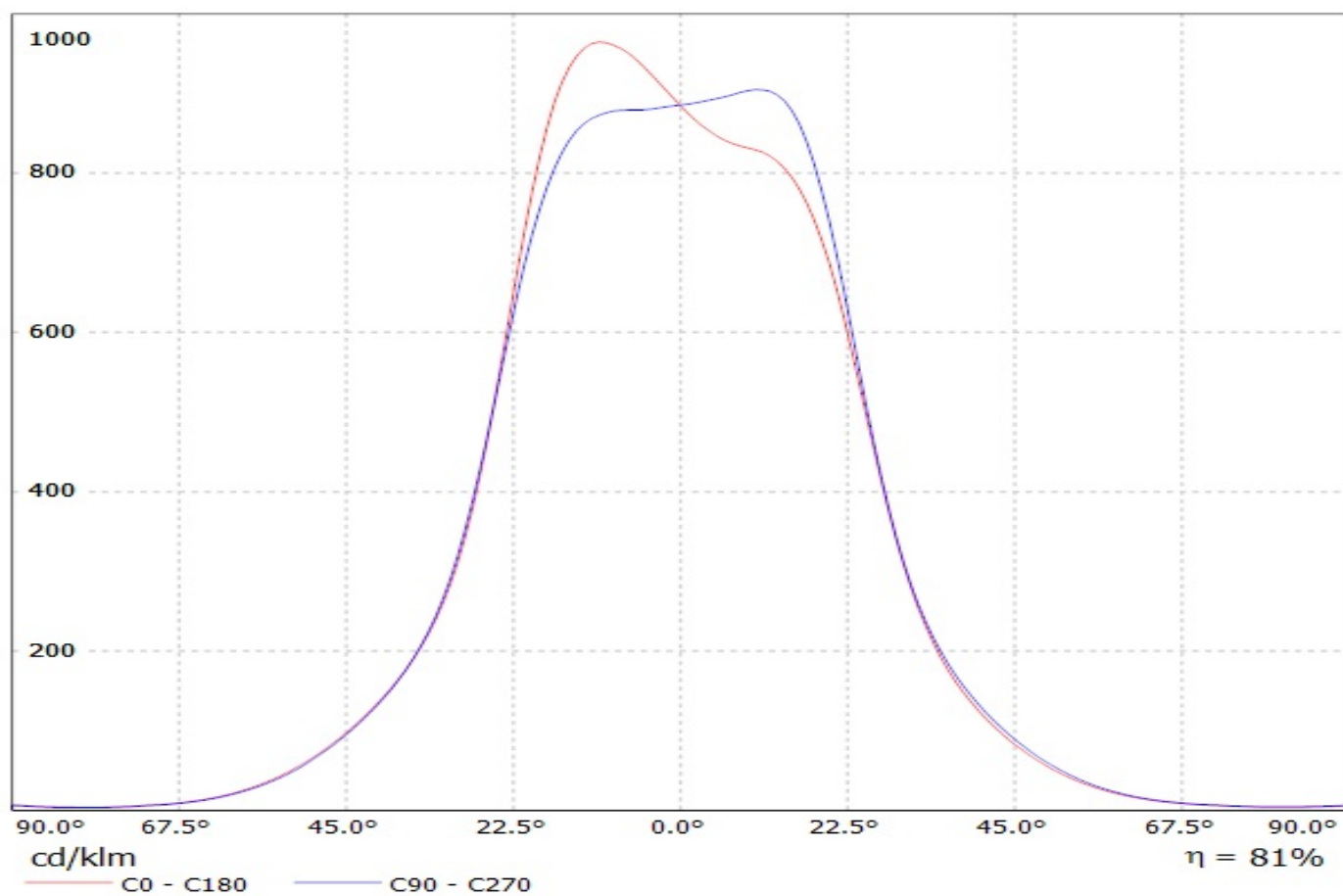

Luminaire: LEDiL Oy CA14442_VERONICA-SQ-W_(Luxeon_MZ)
Lamps: 1 x Philips_Lumileds_Luxeon_MZ_386.758lm@250mA_P=2.77489W_I=0.2499A

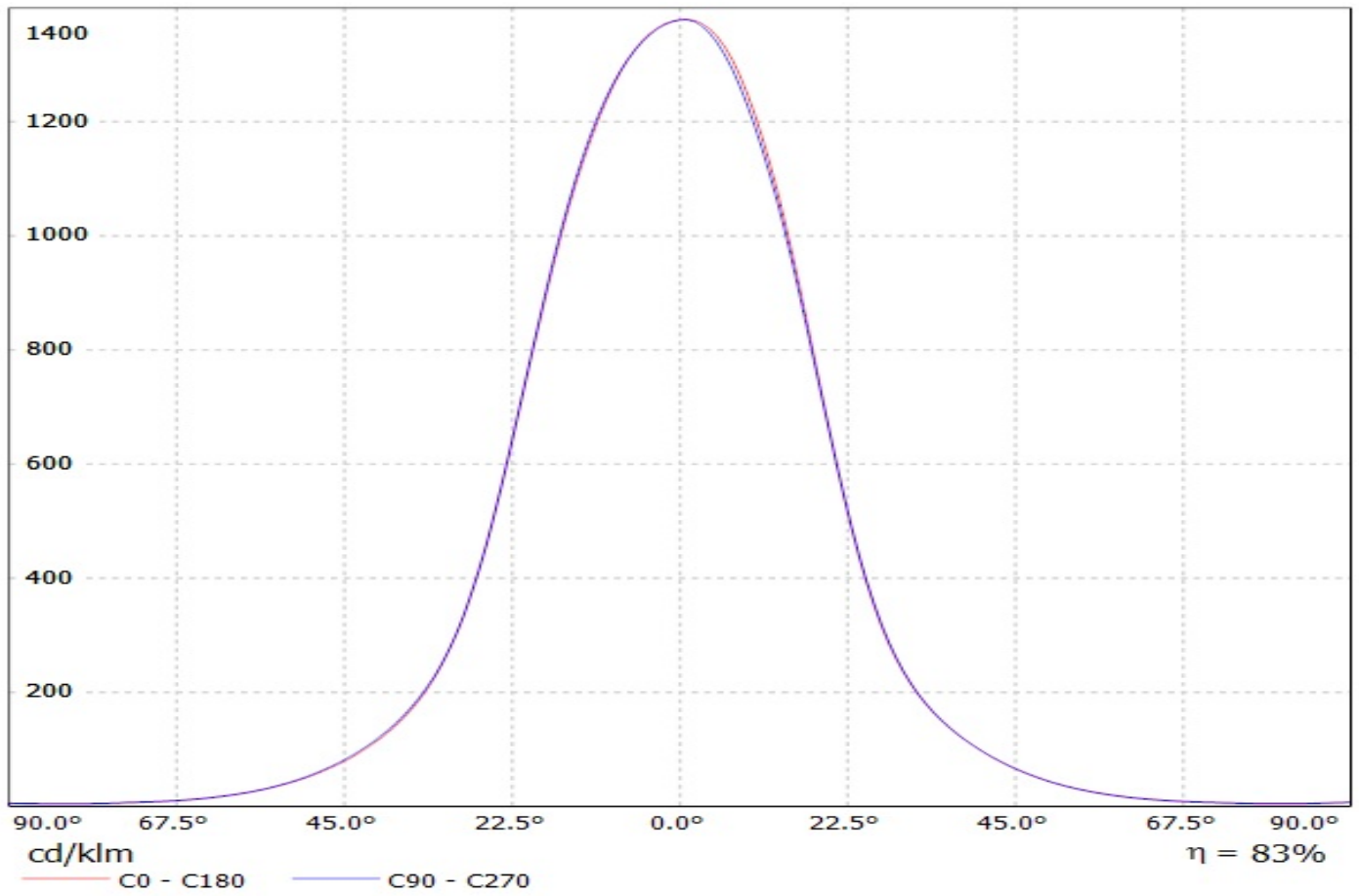

Luminaire: LEDiL Oy CA14442_VERONICA-SQ-W_(Luxeon_R)

Lamps: 1 x Philips_Lumileds_Luxeon_R_(LXA7-PW30)_74.1293lm@250mA_CCT=3049K_P=0.727484W_I=0.2499A

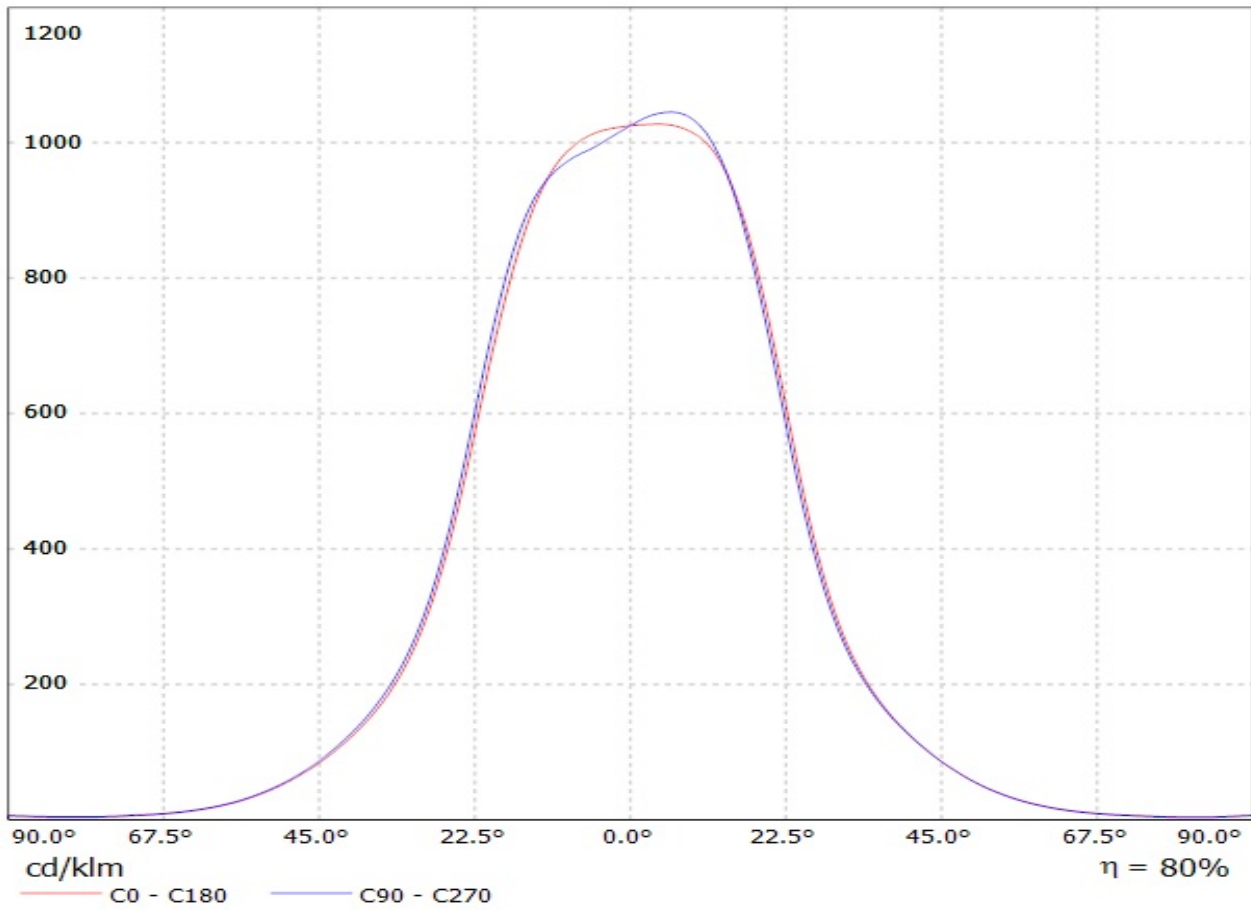

Luminaire: LEDiL Oy CA14442_VERONICA-SQ-W_(Luxeon_T)

Lamps: 1 x Philips_Lumileds_Luxeon_T_(LXH8-FW30-3)_72.2743lm@250mA_P=0.734231W_I=0.2499A

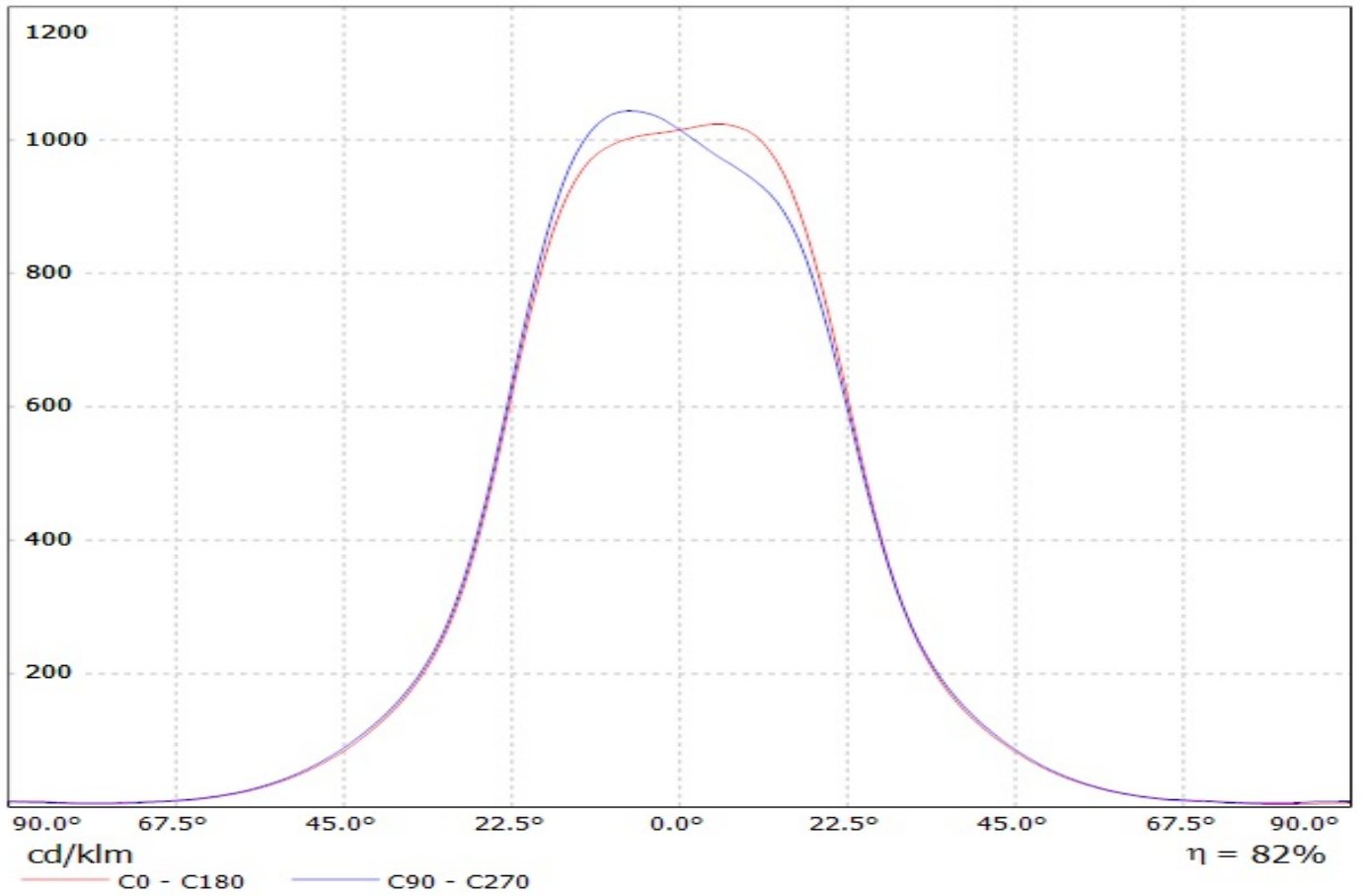

Luminaire: LEDiL Oy CA14442_VERONICA-SQ-W_(Luxeon_TX)

Lamps: 1 x Philips_Lumileds_Luxeon_TX_(L1T2-3585)_80.8039lm@250mA_CCT=3554K_P=0.740679W_I=0.2499A

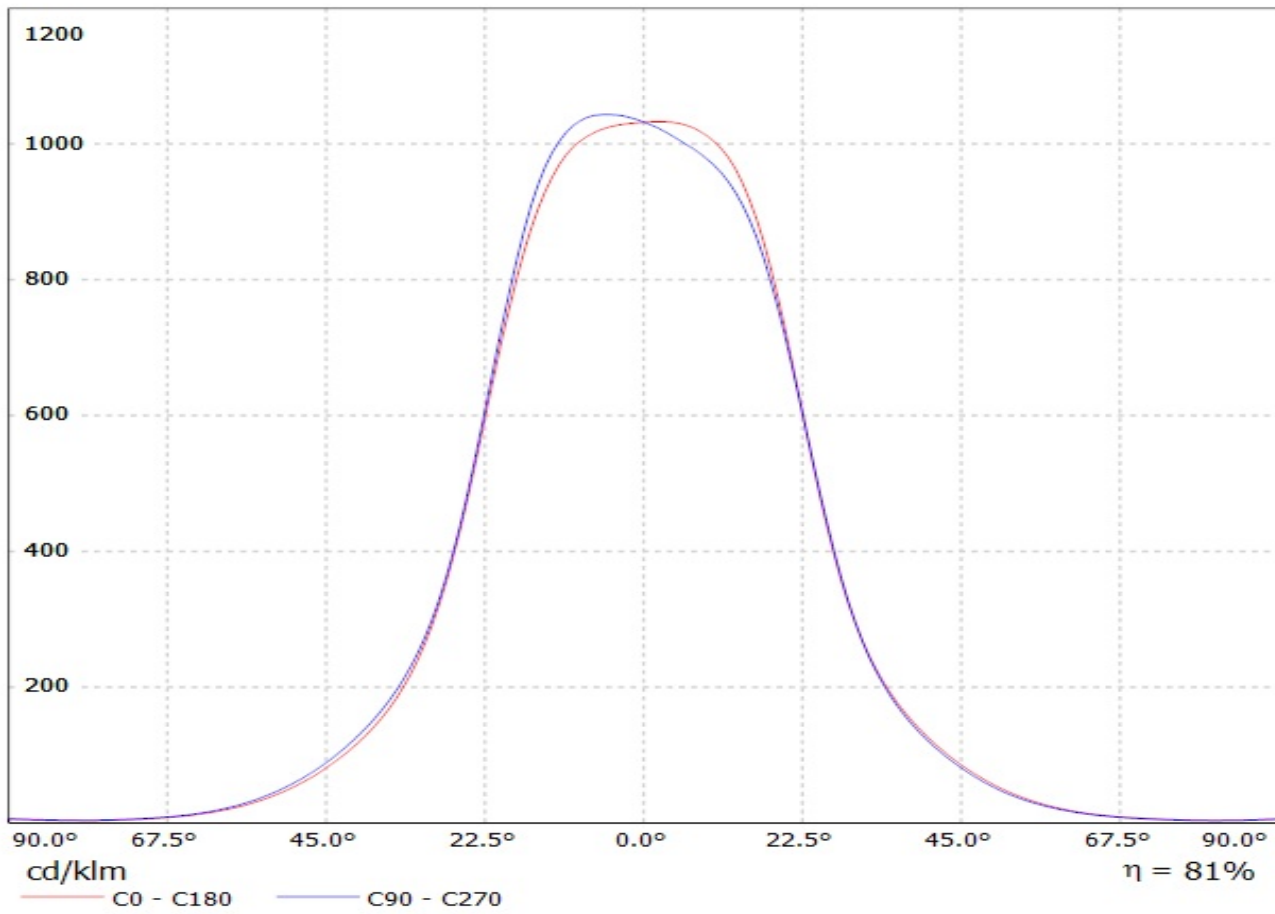

Luminaire: LEDiL Oy CA14442_VERONICA-SQ-W (Luxeon_Rebel_ES)

Lamps: 1 x Philips_Lumileds_Luxeon_Rebel_ES_(LXML-PWC2)_89.4472lm@250mA_P=0.746101W_I=0.2499A

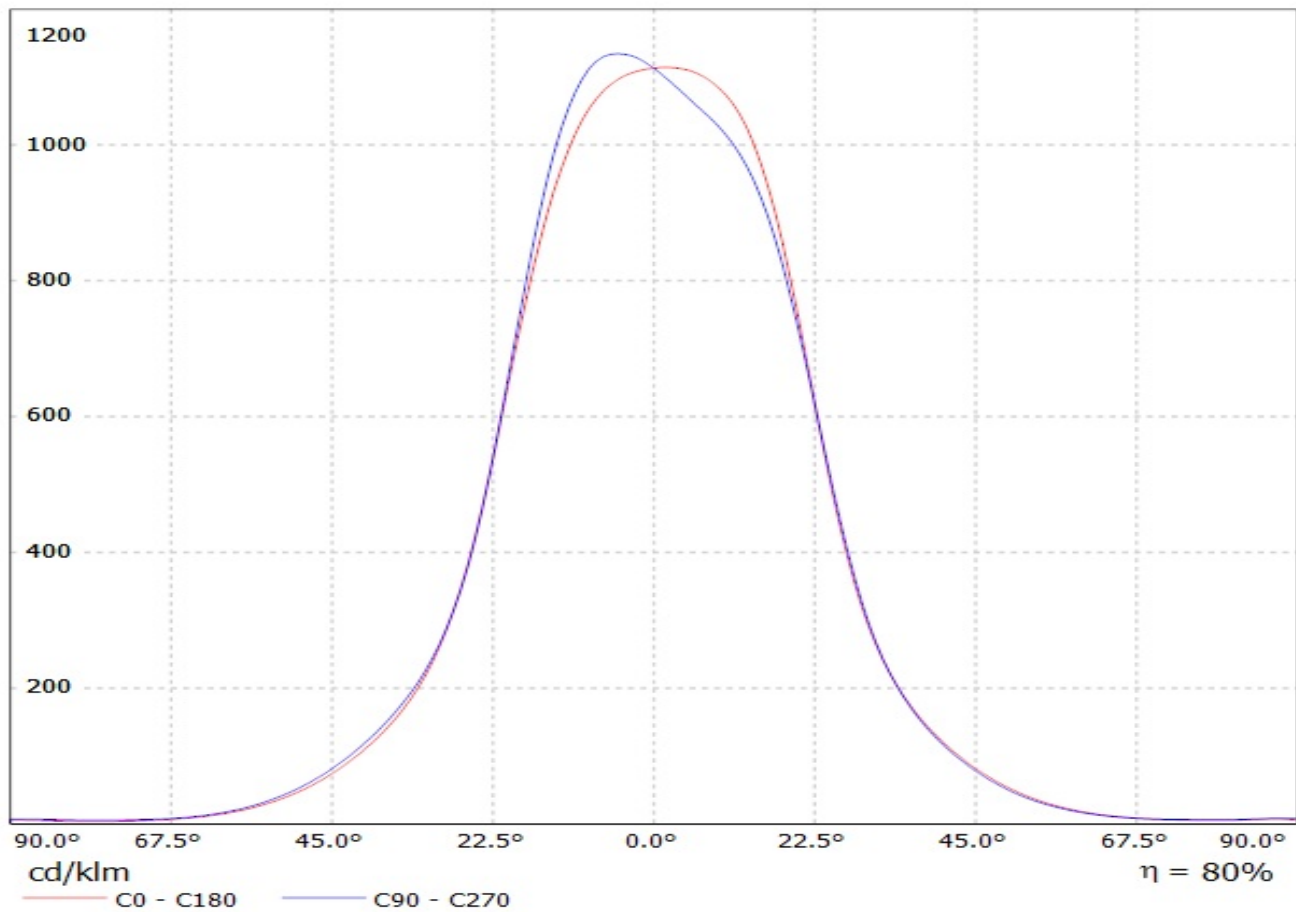

Luminaire: LEDiL Oy CA14442_VERONICA-SQ-W_(Luxeon_A)

Lamps: 1 x Philips_Lumileds_Luxeon_A_(LXH8-PW30)_65.8365lm@250mA_P=0.727284W_I=0.2499A

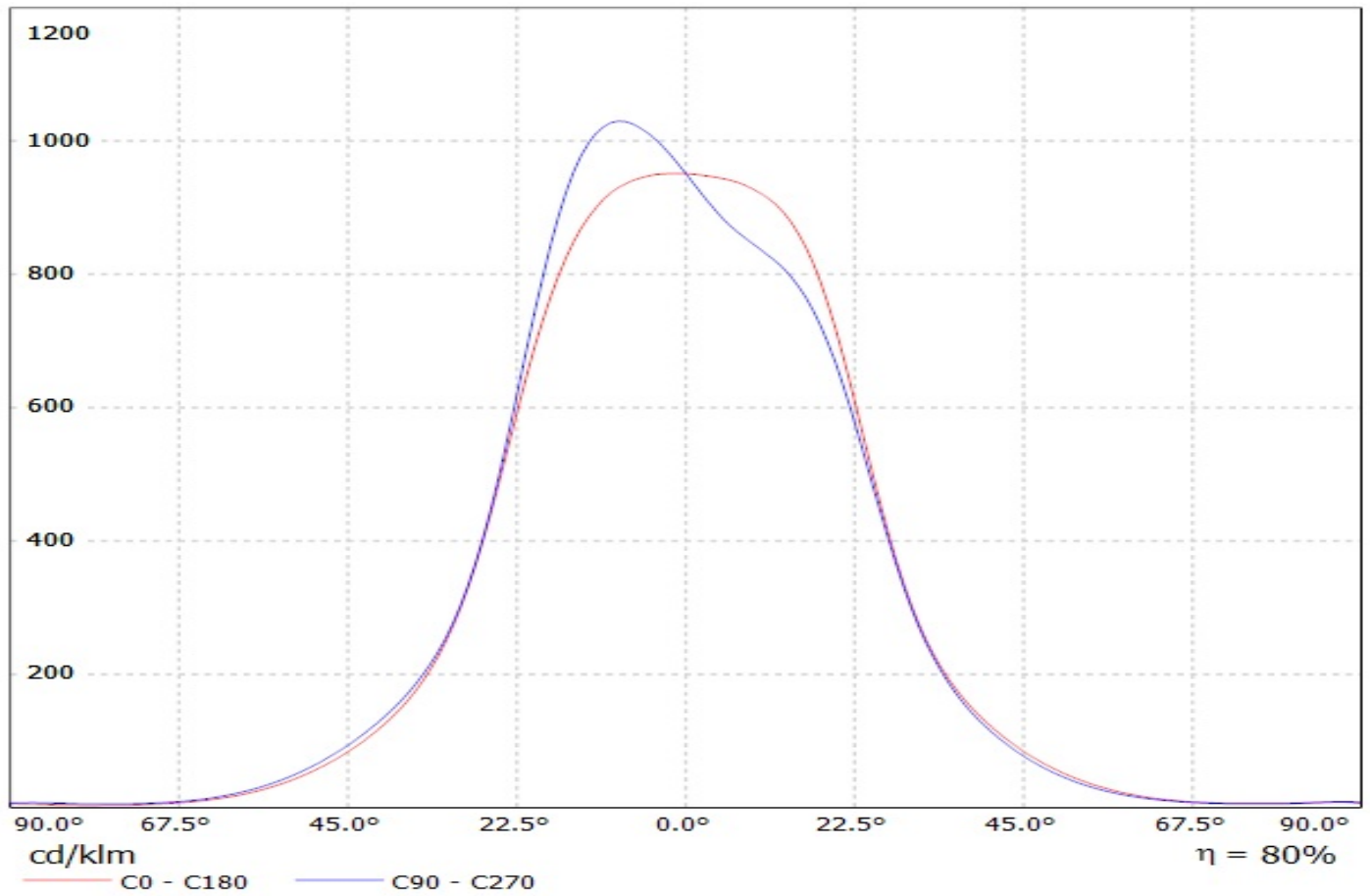

Luminaire: LEDiL Oy CA14442_VERONICA-SQ-W_(Nichia_NV5xx19B)
Lamps: 1 x Nichia_NV5xx19B_105.826lm@250mA_P=0.731182W_I=250mA

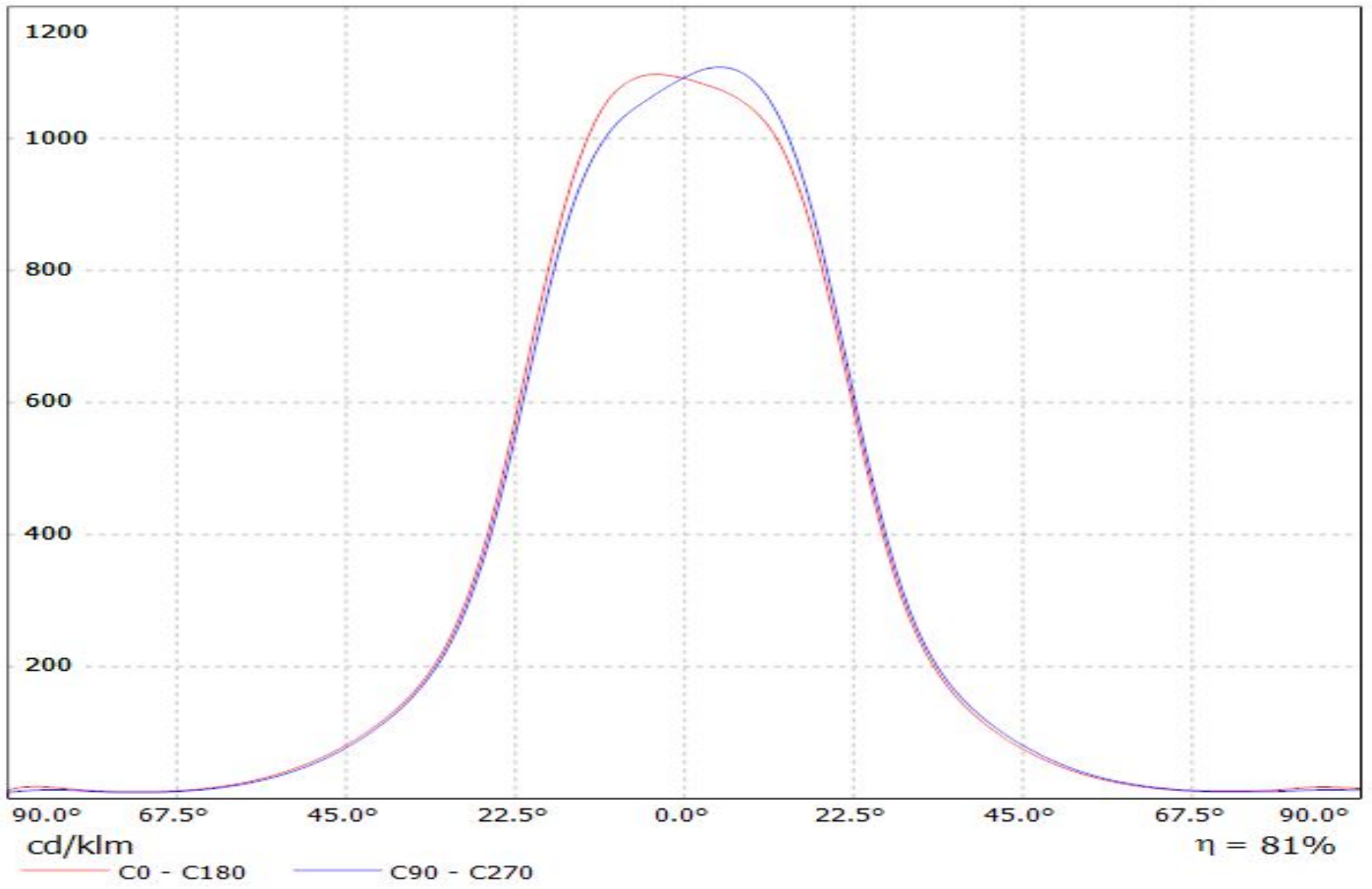

Luminaire: LEDiL Oy CA14442_VERONICA-SQ-W_(NCSxx19B) Nichia_NCSxx19B_(NCSL219B)_76.9443lm@250mA_P=0.779638W_I=0.2499A
Lamps: 1 x Nichia_NCSxx19B_(NCSL219B)_76.9443lm@250mA_P=0.779638W_I=0.2499A

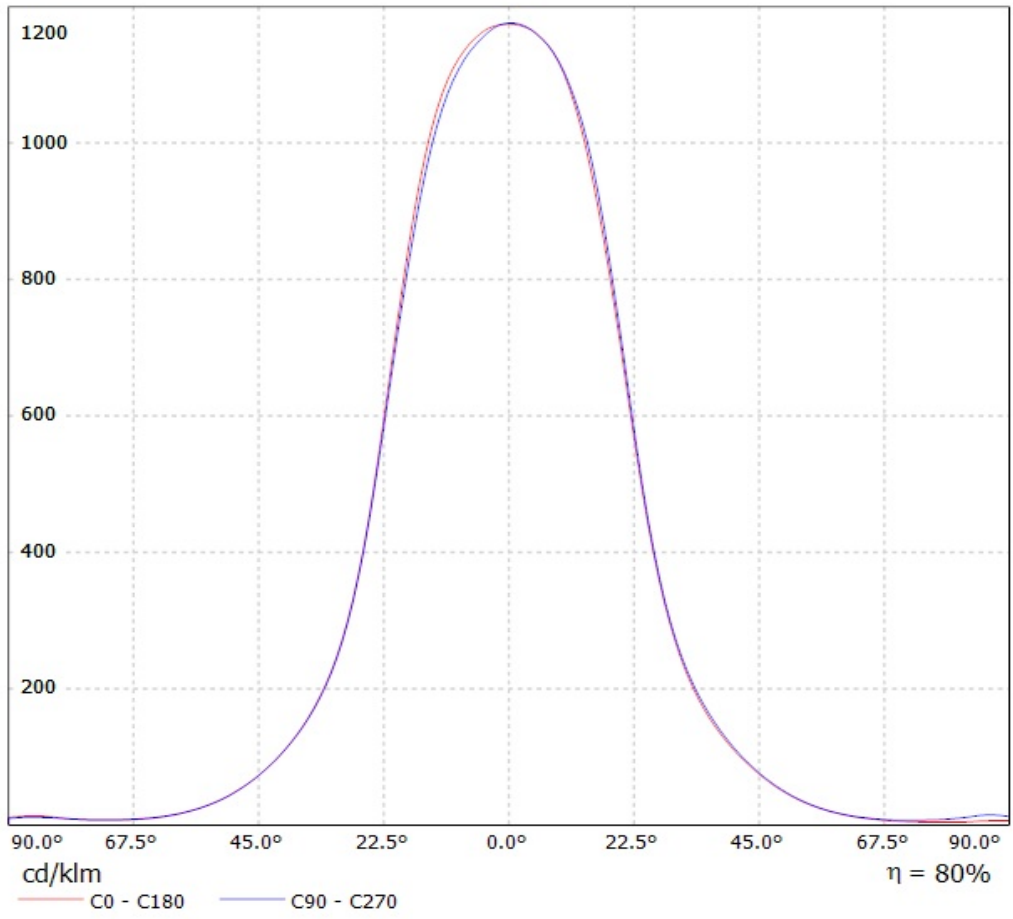

Luminaire: LEDiL Oy CA14442_VERONICA-SQ-W_(NWSL229AE)

Lamps: 1 x Nichia_NWSL229AE_120.54lm@250mA_P=0.7128W_I=0.250A

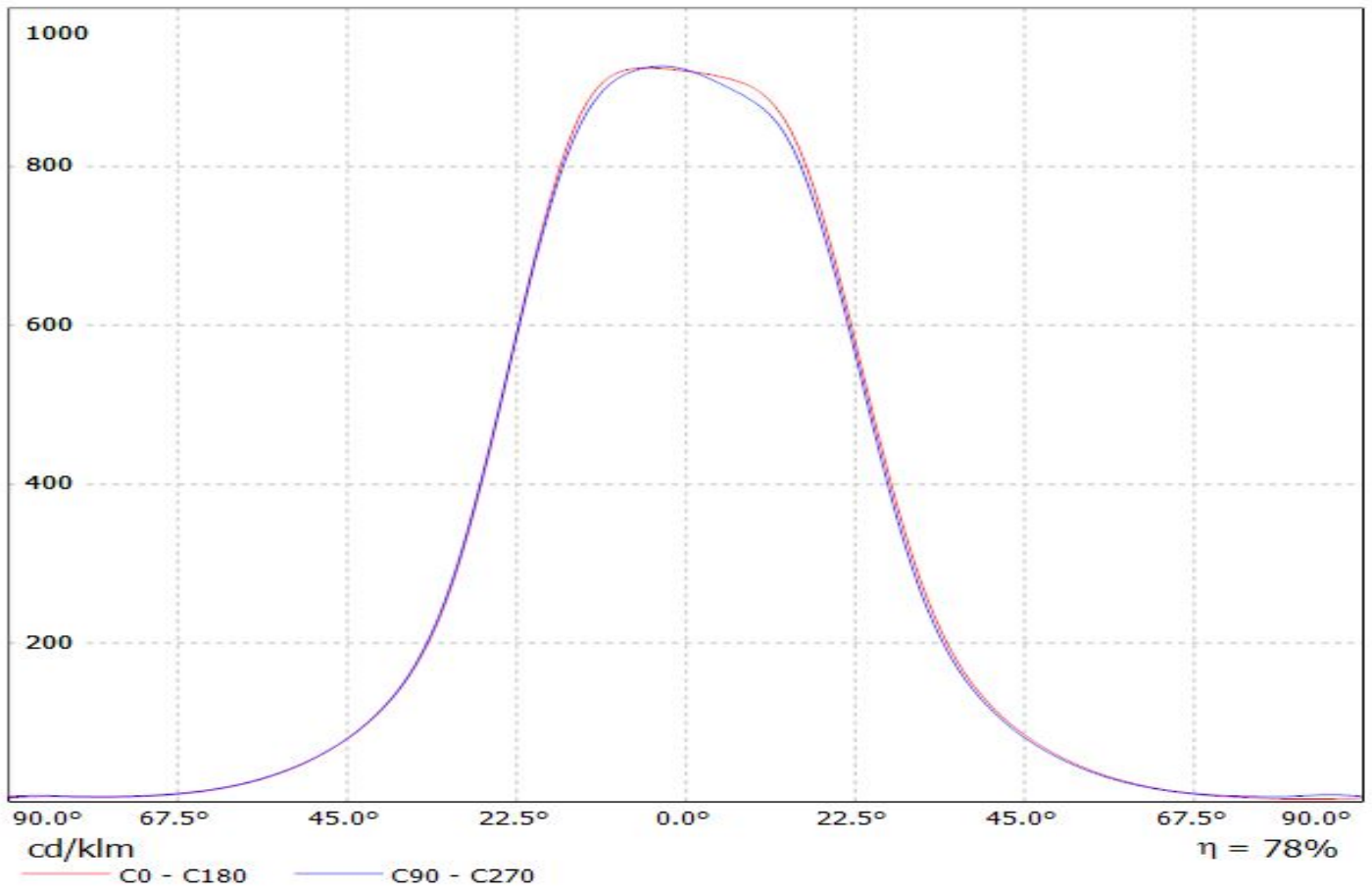

Luminaire: LEDiL Oy CA14442_VERONICA-SQ-W_(NVSW3x9A)

Lamps: 1 x Nichia_NVSW3x9A_(sm405/R70)_122.334lm@250mA_P=0.705435W_I=0.250A

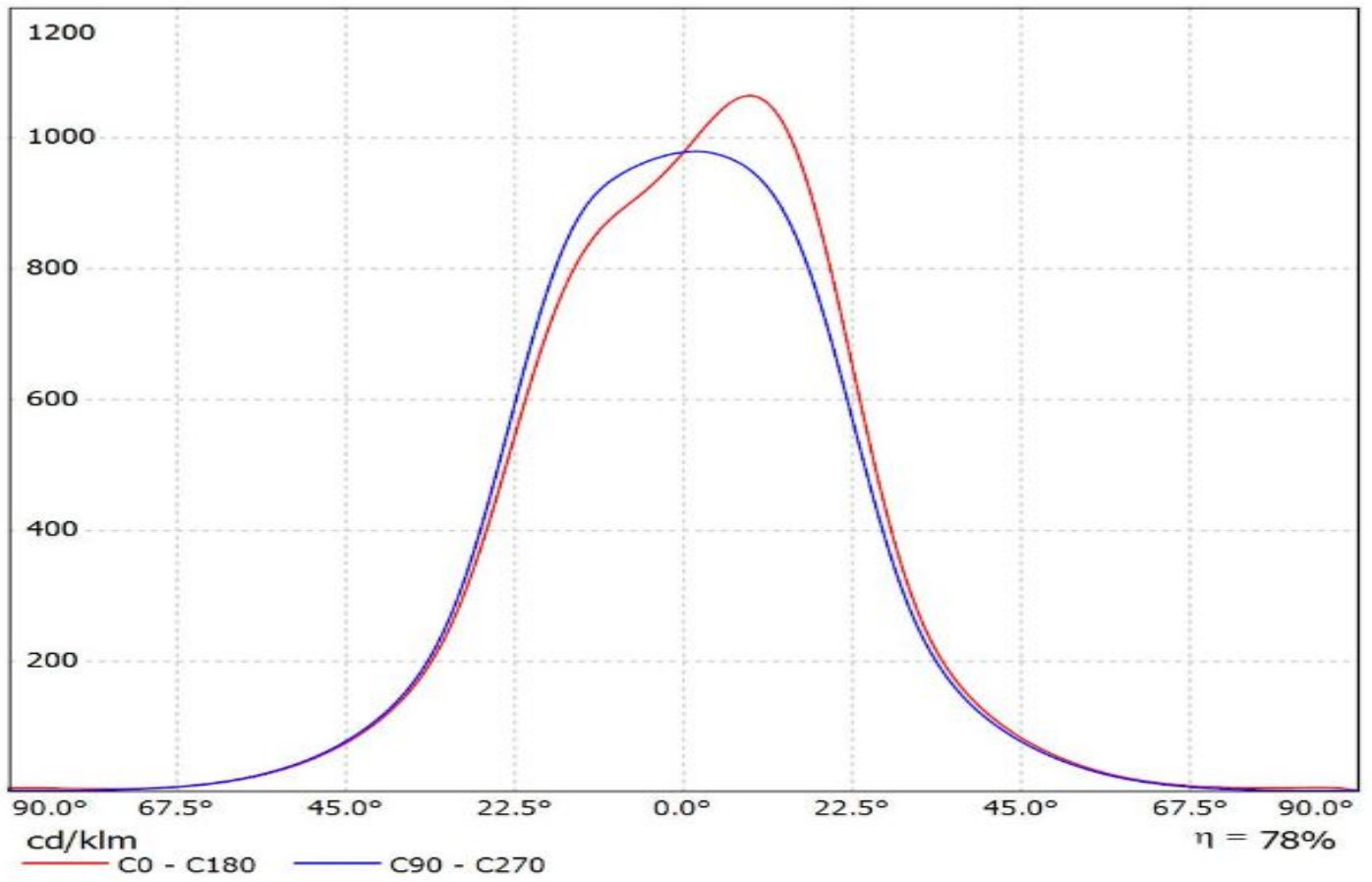

Luminaire: LEDiL Oy CA14442_VERONICA-SQ-W_(Oslon_SSL_80)

Lamps: 1 x Osram_Oslon_SSL_80_(LUW_CP7P-KTLP-5C8E-35-2)_75.7431lm@250mA_P=0.82352W_I=0.2499A

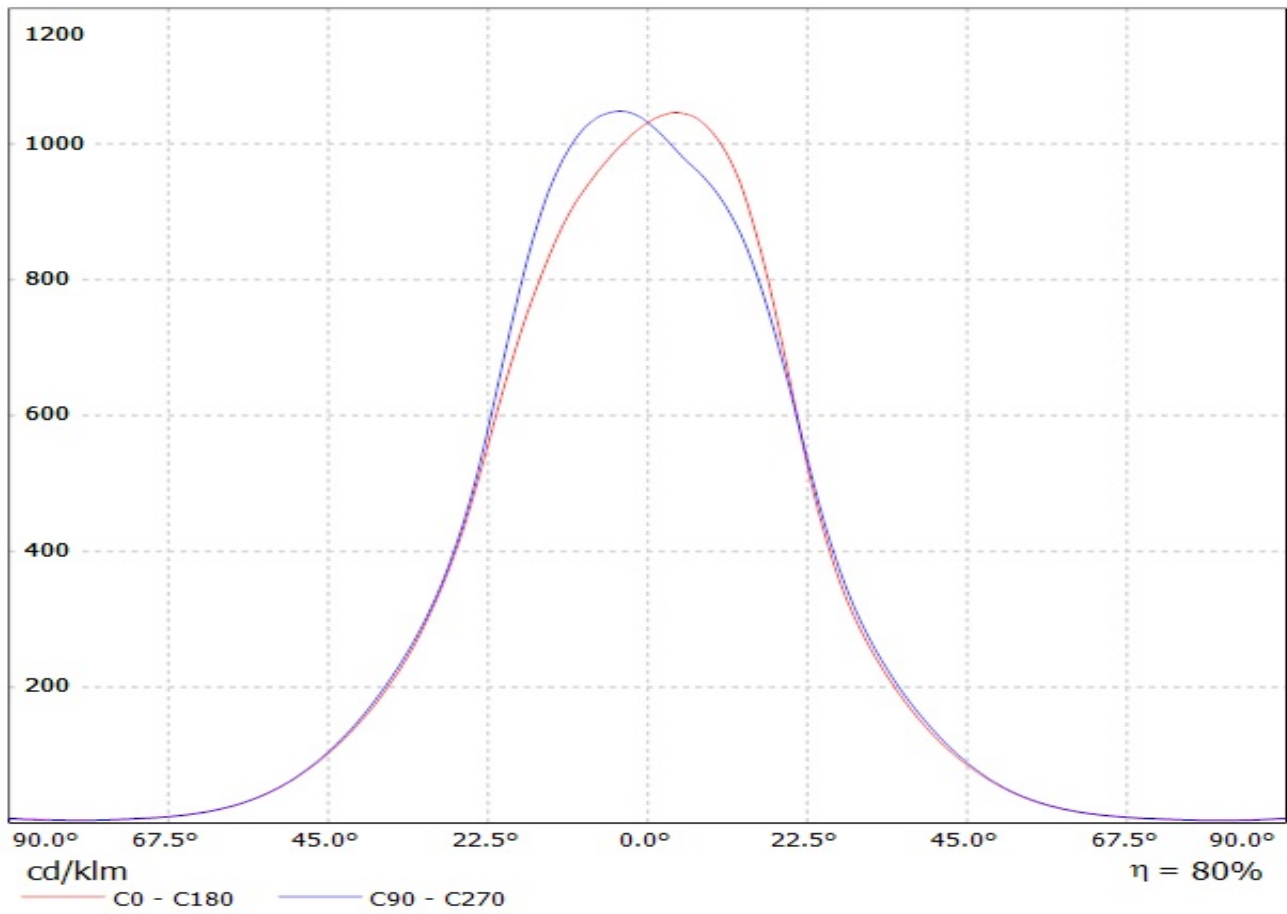

Luminaire: LEDiL Oy CA14442_VERONICA-SQ-W_(Oslon_Square_PC)

Lamps: 1 x Osram_Oslon_Square-PC_(LCW_CQAR.PL-MSMV-5H71-1)_99.714lm@250mA_P=0.770717W_I=0.2499A

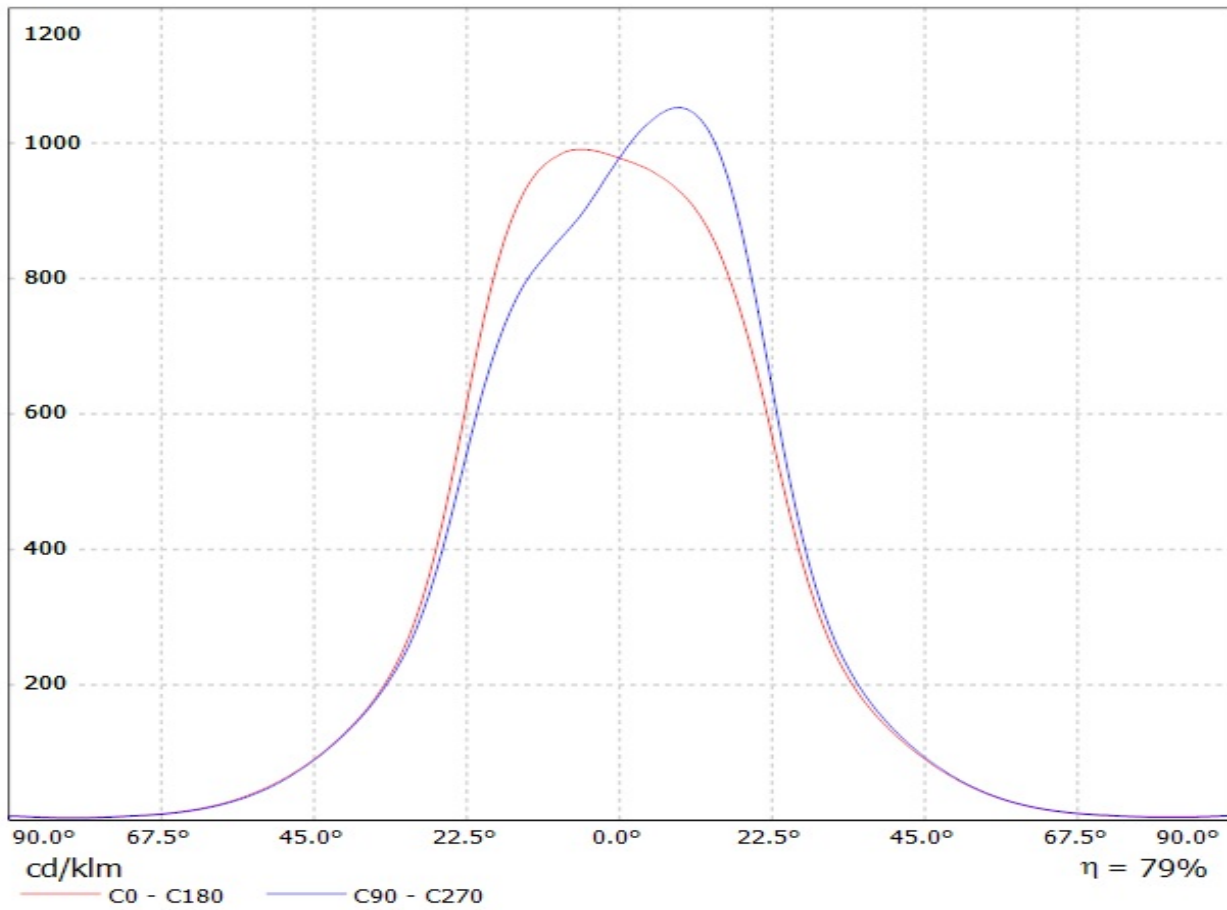

Luminaire: LEDiL Oy CA14442_VERONICA-SQ-W_(Oslon_Square_EC)

Lamps: 1 x Osram_Oslon_Square_EC_(GW_CSSRM1.EC)_85.3477lm@250mA_P=0.738904W_I=0.2499A

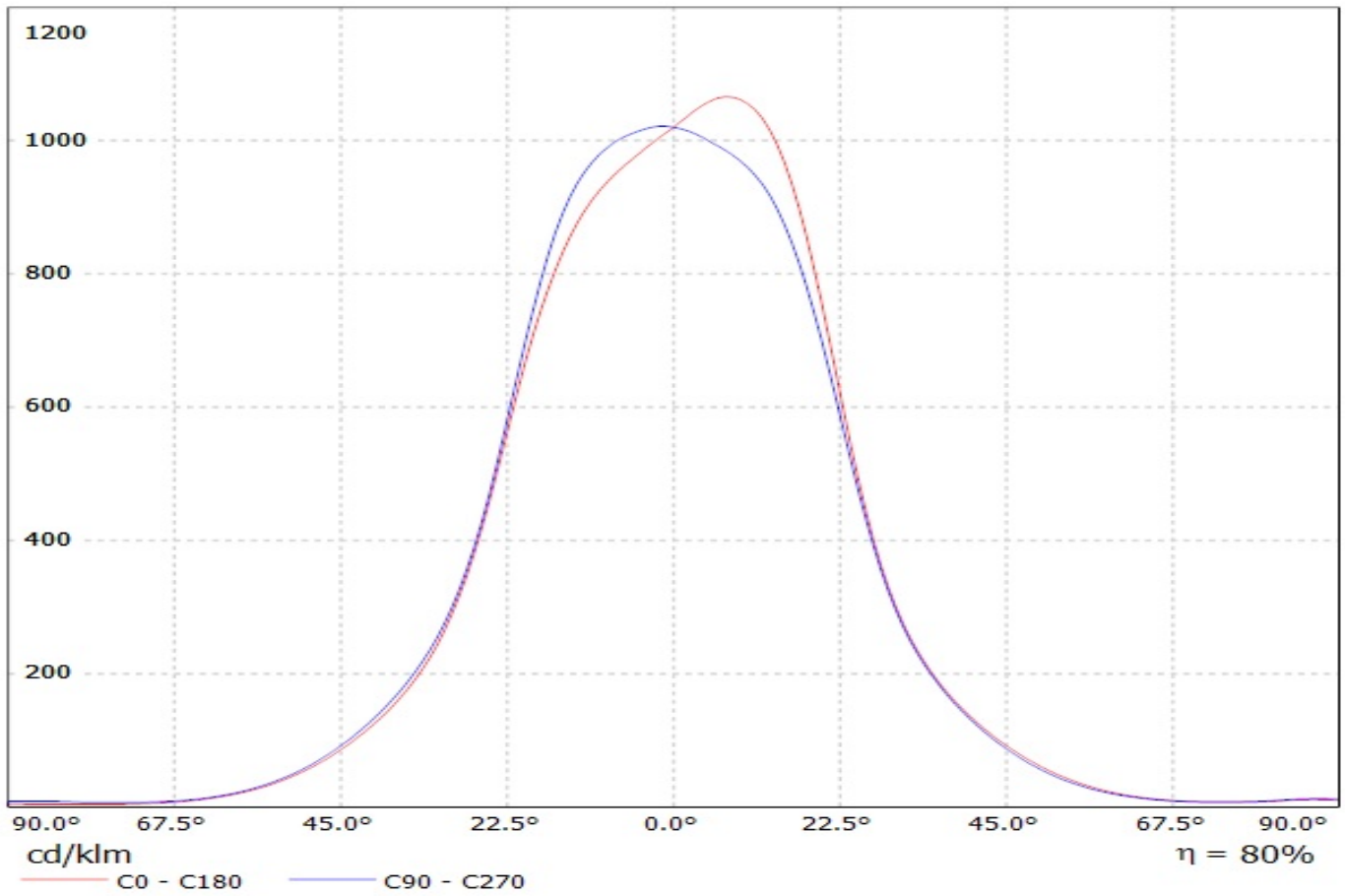

Luminaire: Ledil Oy CA14442_VERONICA-SQ-W_(Duris_P10)_SIMULATED
Lamps: 1 x Osram Duris P10

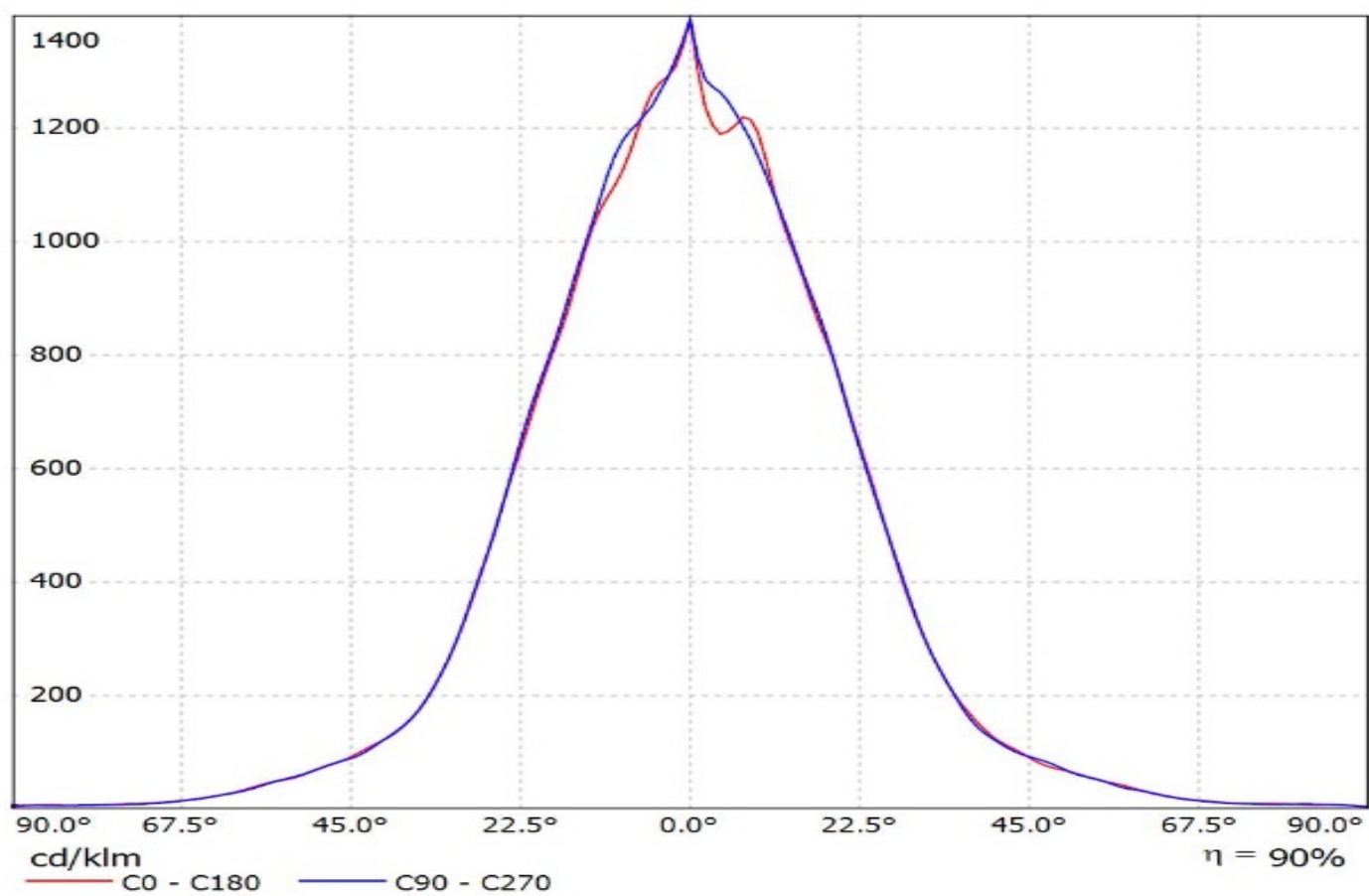

Luminaire: LEDiL Oy CA14442_VERONICA-SQ-W_(Z8Y22plus)

Lamps: 1 x Seoul_Z8Y22plus_(W6E2G)_125.652lm@250mA_P=0.69312W_I=0.250A

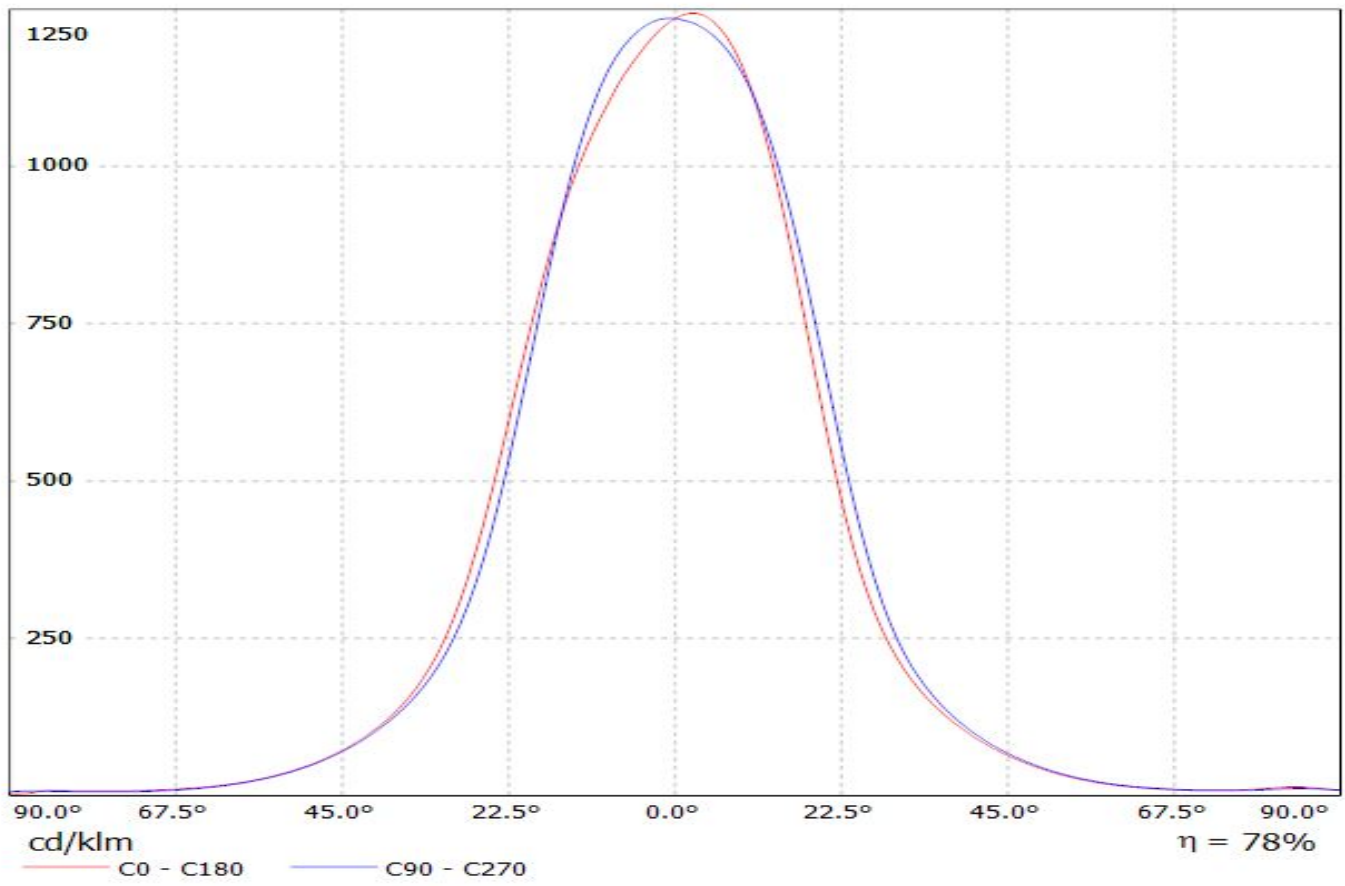

Luminaire: LEDiL Oy CA14442_VERONICA-SQ-W_(XB-H)

Lamps: 1 x Cree_XB-H_(XBHAWT-0-7C1-T30-0H-0001)_97.2452lm@250mA_P=0.755198W_I=0.2499A

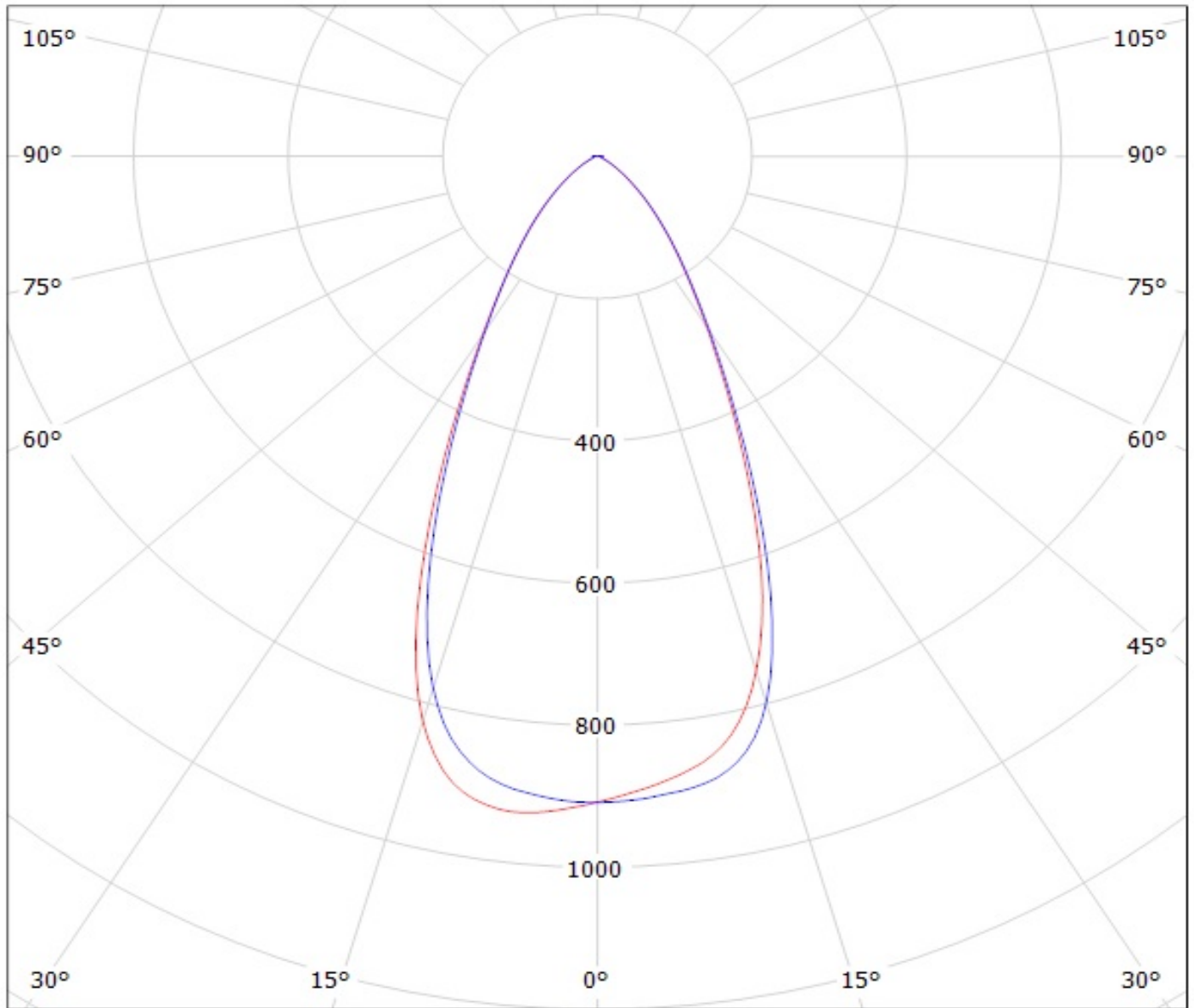

cd/klm

— C0 - C180

— C90 - C270

$\eta = 80\%$

Luminaire: LEDiL Oy CA14442_VERONICA-SQ-W_(XM-L2)

Lamps: 1 x Cree_XM-L2_(XMLBWT-0-7B4-T30-0L-0001)_88.0594lm@250mA_P=0.738554W_I=0.2499A

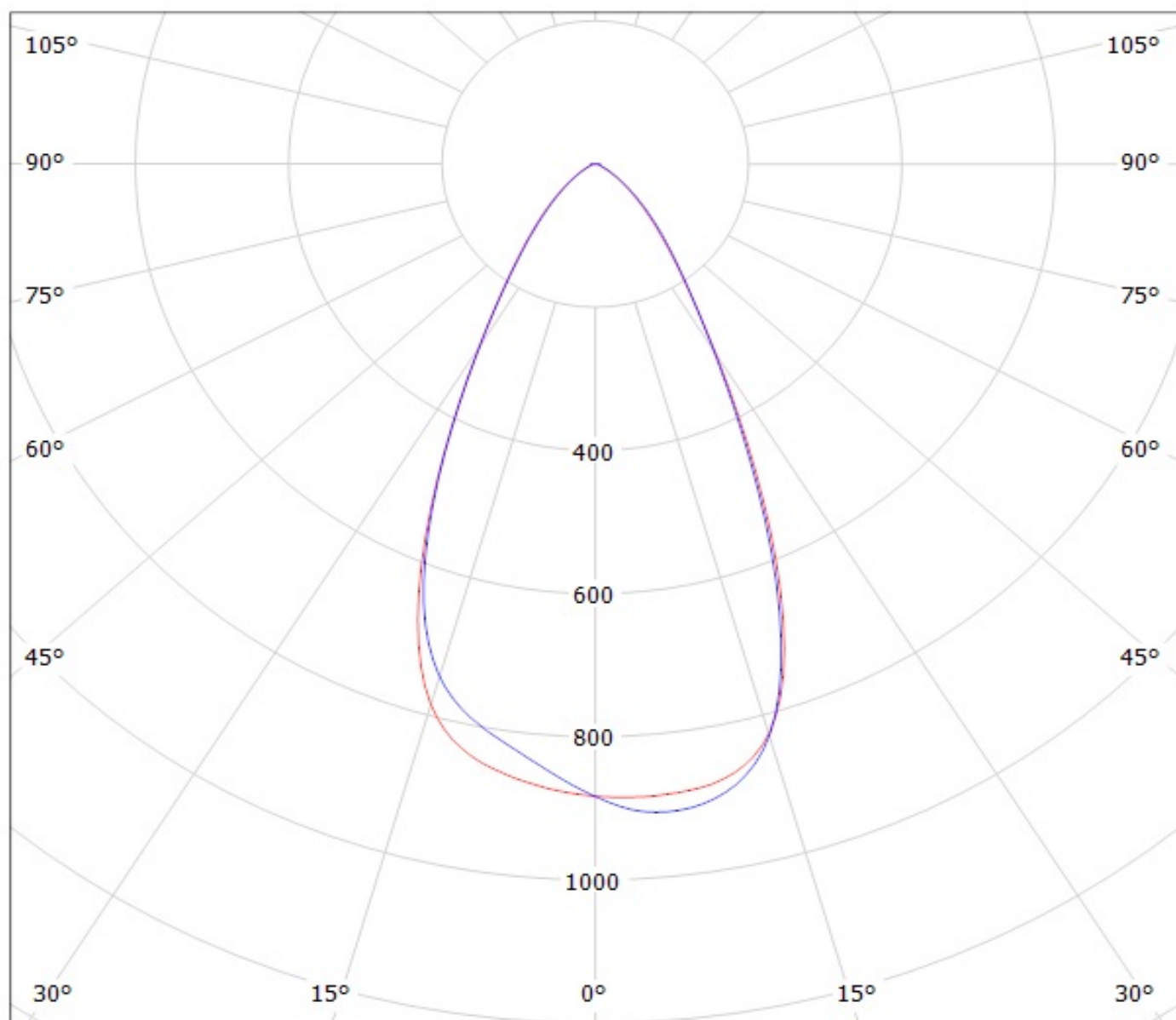

cd/klm

— C0 - C180

— C90 - C270

$\eta = 80\%$

Luminaire: LEDiL Oy CA14442_VERONICA-SQ-W_(XT-E)

Lamps: 1 x Cree_XT-E_(XTEAWT-0-2A0-R30-FB-0001)_98.1299lm@250mA_CCT=5453K_P=0.781812W_I=0.2499A

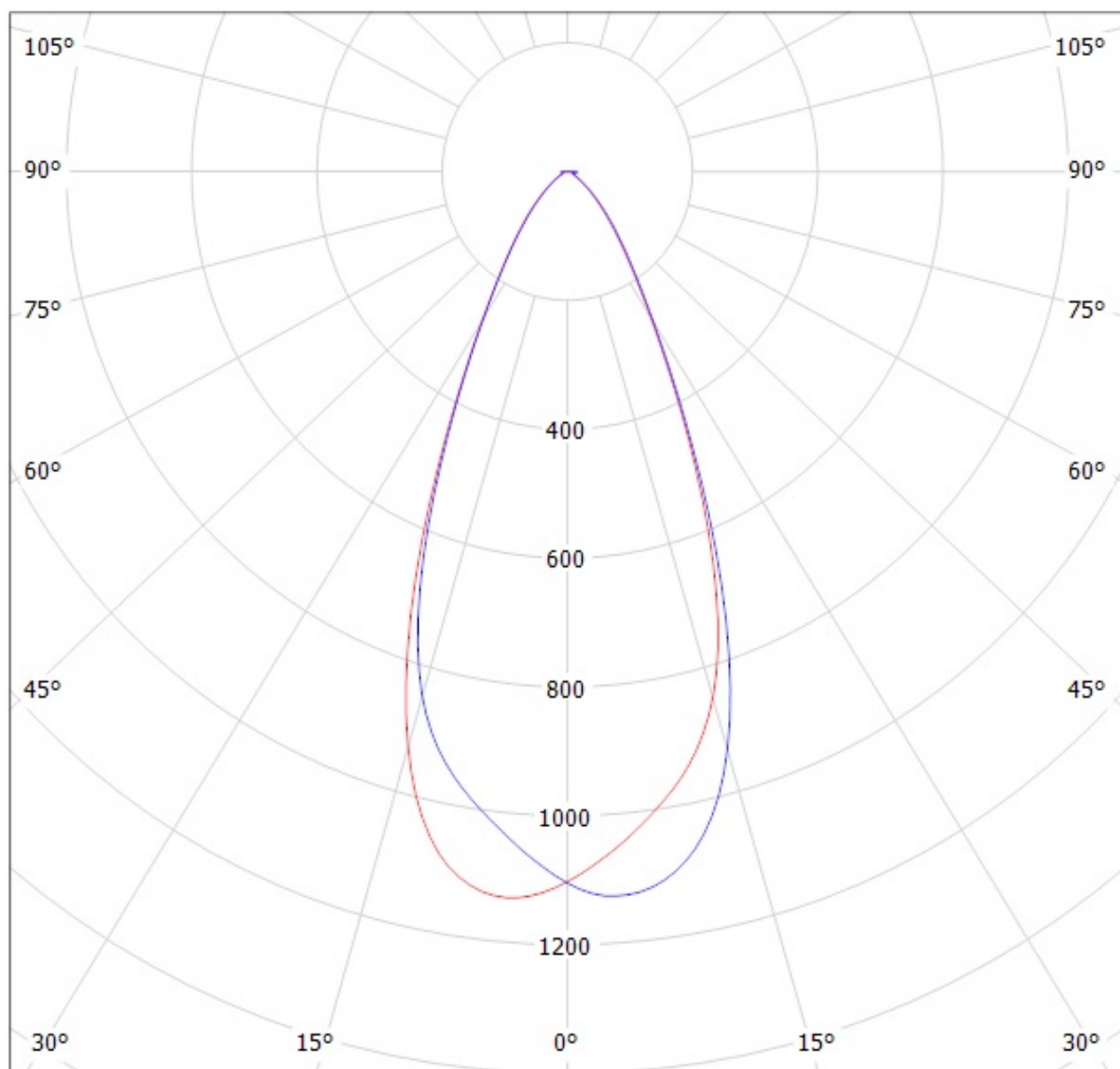

cd/klm

— C0 - C180

— C90 - C270

$\eta = 80\%$

Luminaire: LEDiL Oy CA14442_VERONICA-SQ-W_(XM-L)

Lamps: 1 x Cree_XM-L_(XMLAWT-00-0000-0000T6051)_100.156lm@250mA_P=0.72556W_I=0.2499A

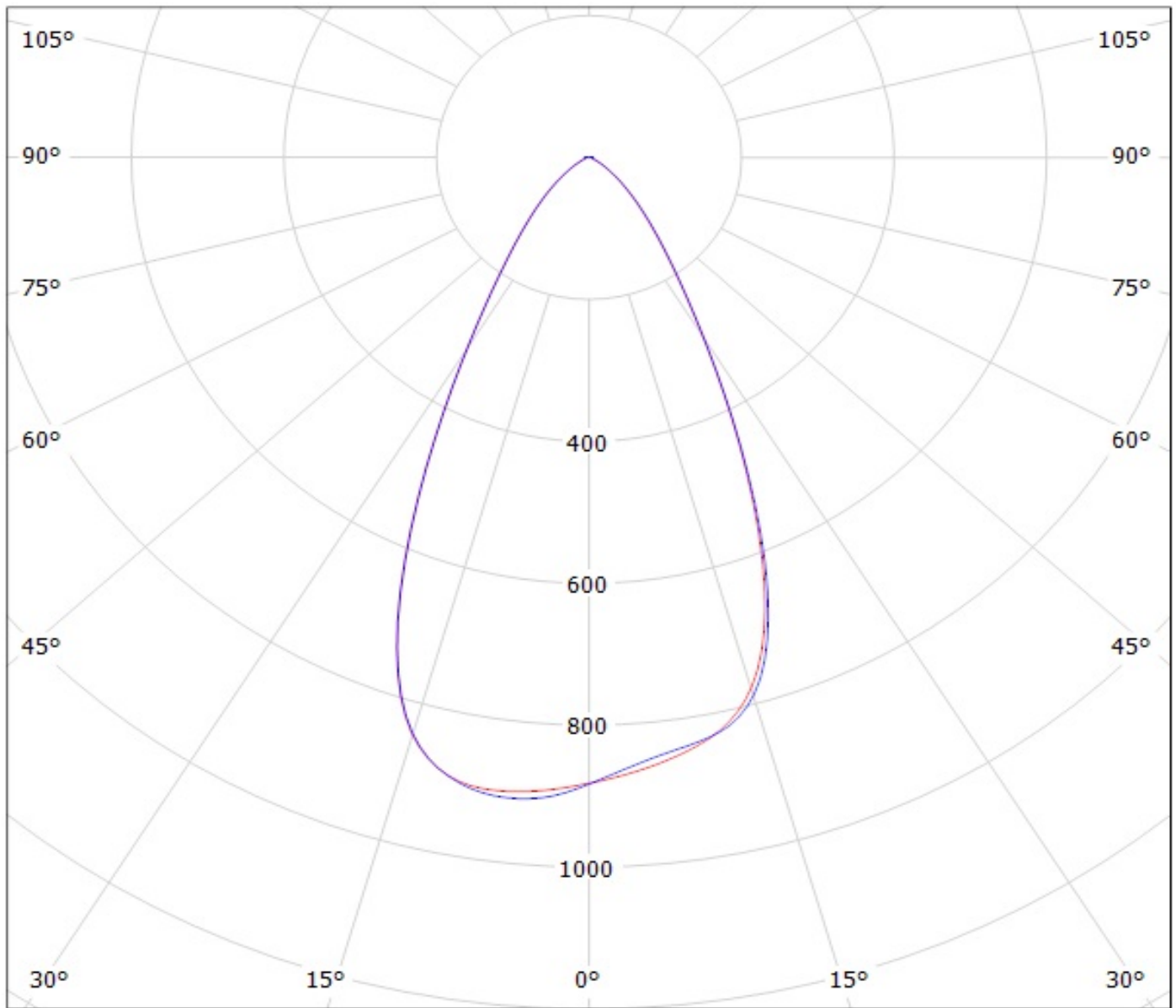

cd/klm

— C0 - C180

— C90 - C270

$\eta = 81\%$

Luminaire: LEDiL Oy CA14442_VERONICA-SQ-W_(XP-E)

Lamps: 1 x Cree_XP-E_(XPEWHT-L1-3C0-Q5-0-06)_78.5375lm@250mA_P=0.803279W_I=0.2499A

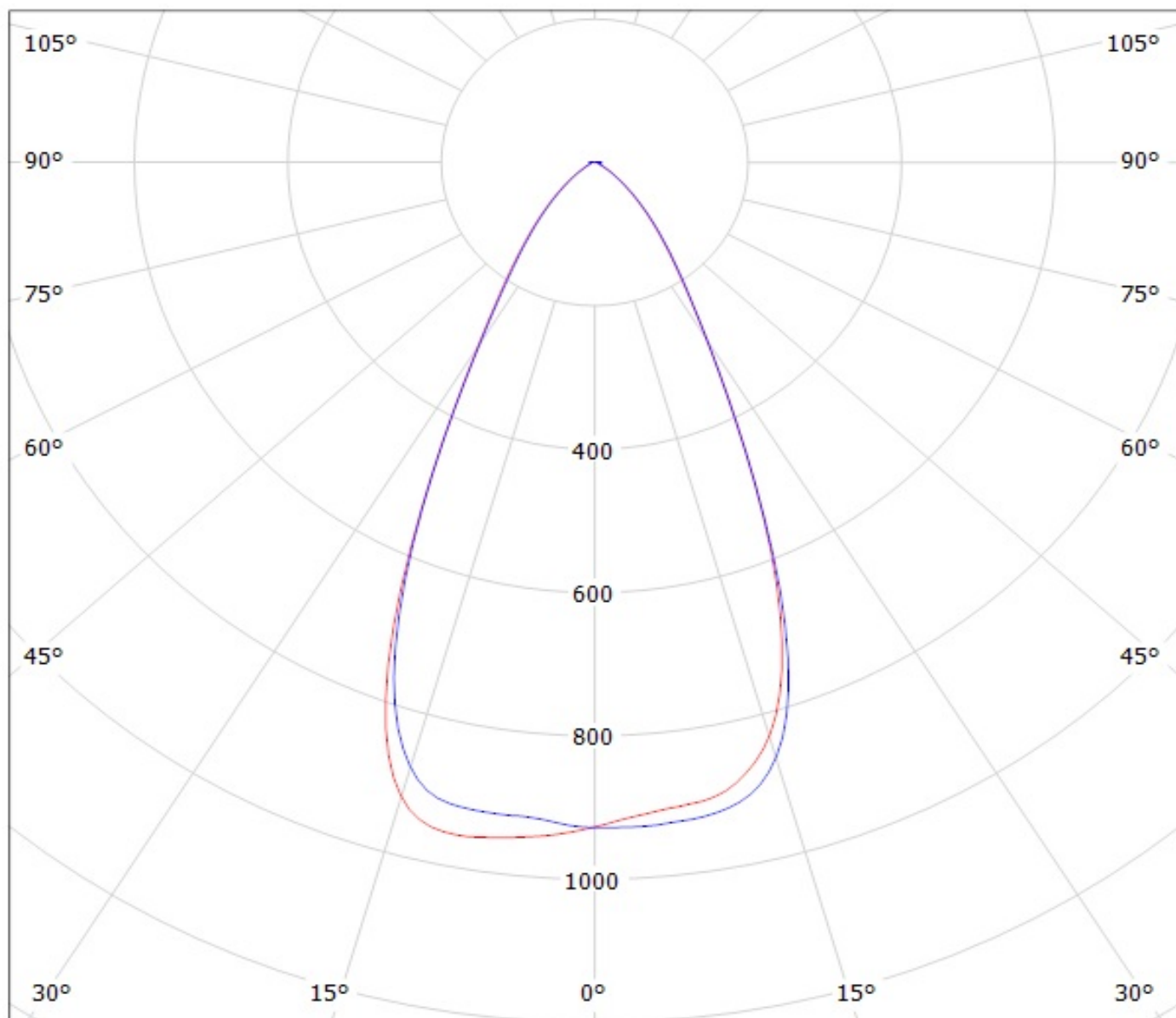

cd/klm

$\eta = 81\%$

— C0 - C180

— C90 - C270

Luminaire: LEDiL Oy CA14442_VERONICA-SQ-W_(XP-G)

Lamps: 1 x Cree_XP-G_(XPGWHT-L1-CWPI-00BE7)_67.193lm@250mA_P=0.769792W_I=0.2499A

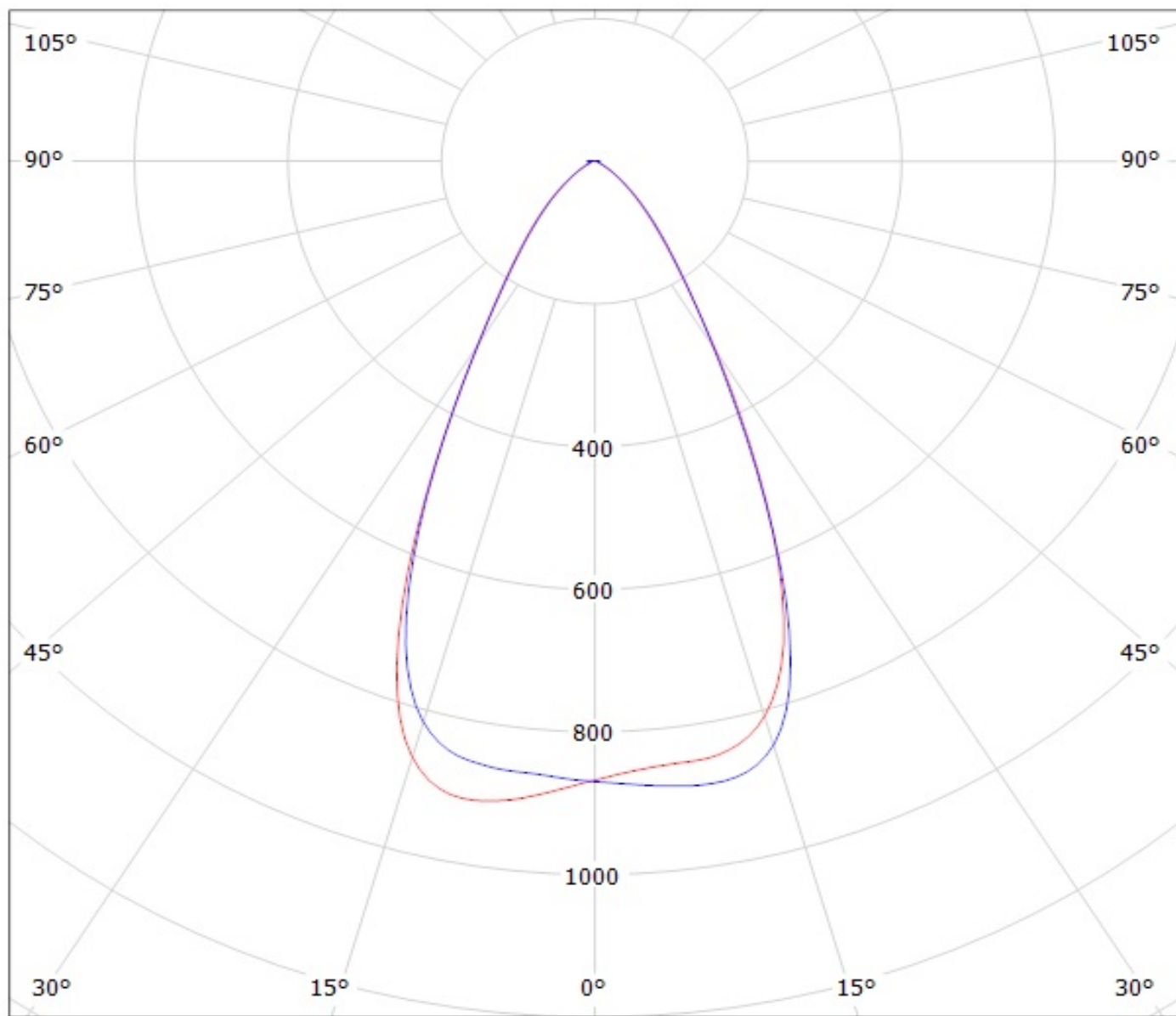

cd/klm

— C0 - C180 — C90 - C270

$\eta = 81\%$

Luminaire: LEDiL Oy CA14442_VERONICA-SQ-W_(H35C1)

Lamps: 1 x LG_H35C1_(PKG5700K)_116.036lm@250mA_CCT=6235K_P=0.757272W_I=0.2499A

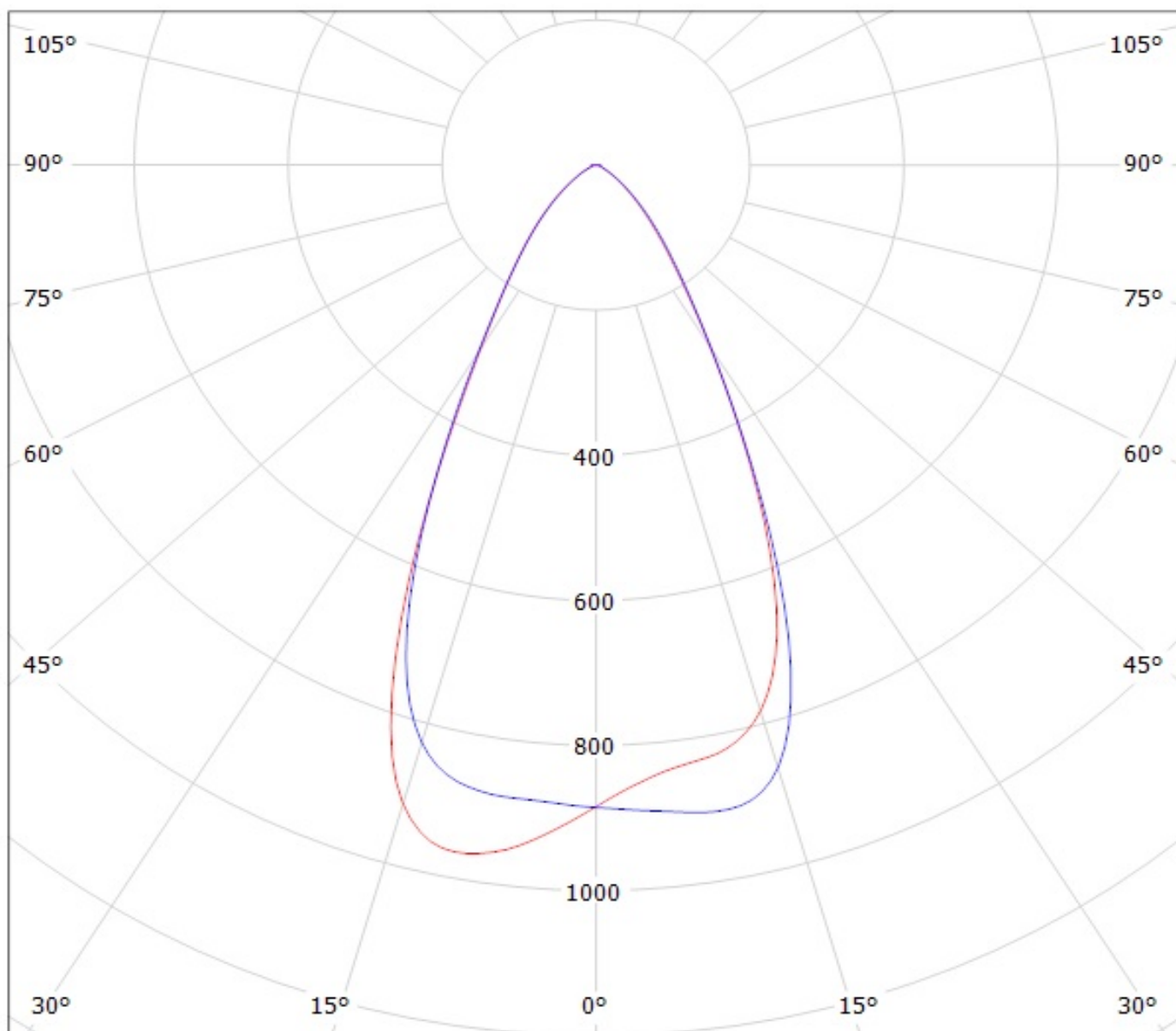

cd/klm

— C0 - C180

— C90 - C270

$\eta = 81\%$

Luminaire: LEDiL Oy CA14442_VERONICA-SQ-W_(Luxeon_MZ)

Lamps: 1 x Philips_Lumileds_Luxeon_MZ_386.758lm@250mA_P=2.77489W_I=0.2499A

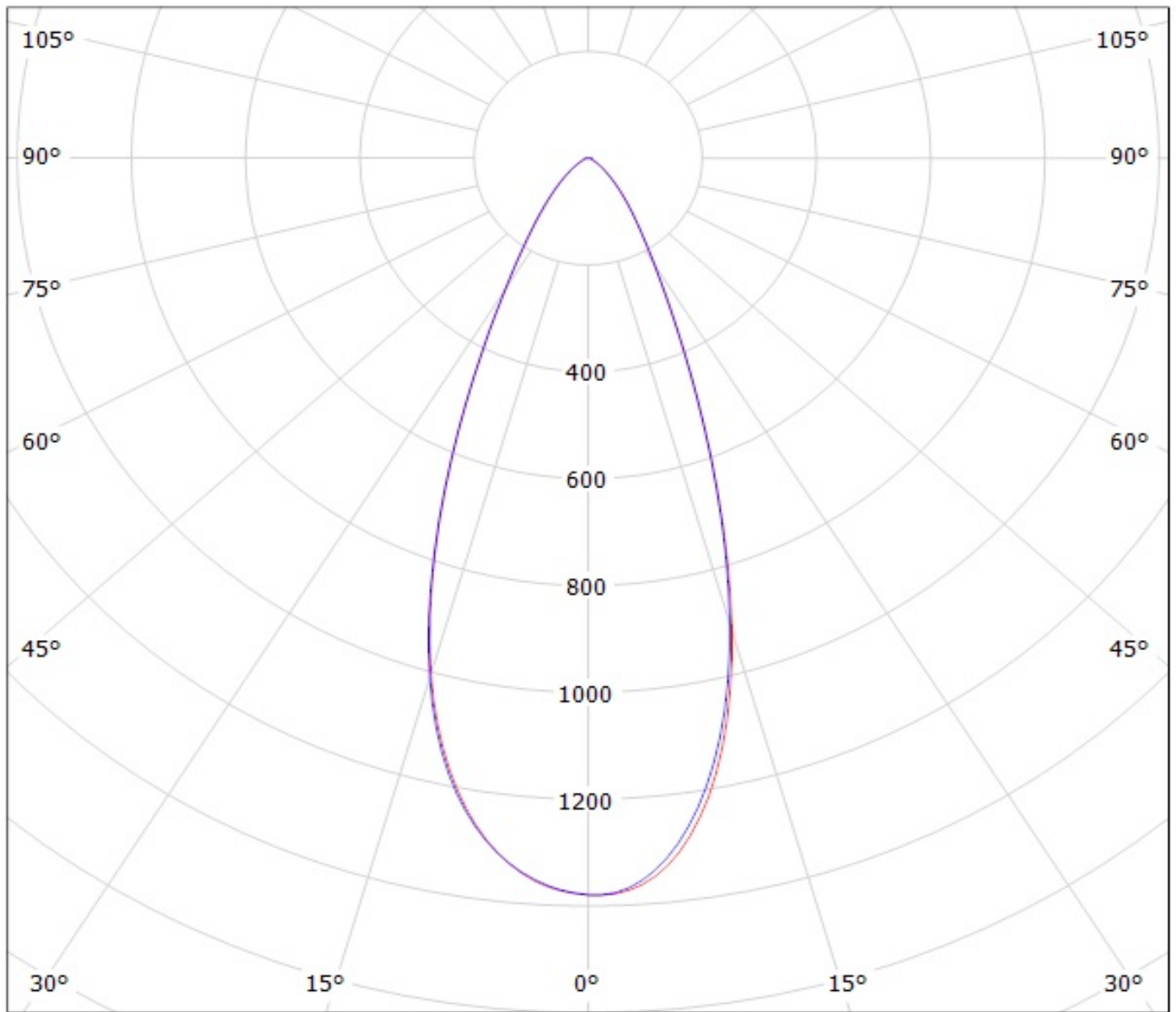

cd/klm

$\eta = 83\%$

— C0 - C180

— C90 - C270

Luminaire: LEDiL Oy CA14442_VERONICA-SQ-W_(Luxeon_R)

Lamps: 1 x Philips_Lumileds_Luxeon_R_(LXA7-PW30)_74.1293lm@250mA_CCT=3049K_P=0.727484W_I=0.2499A

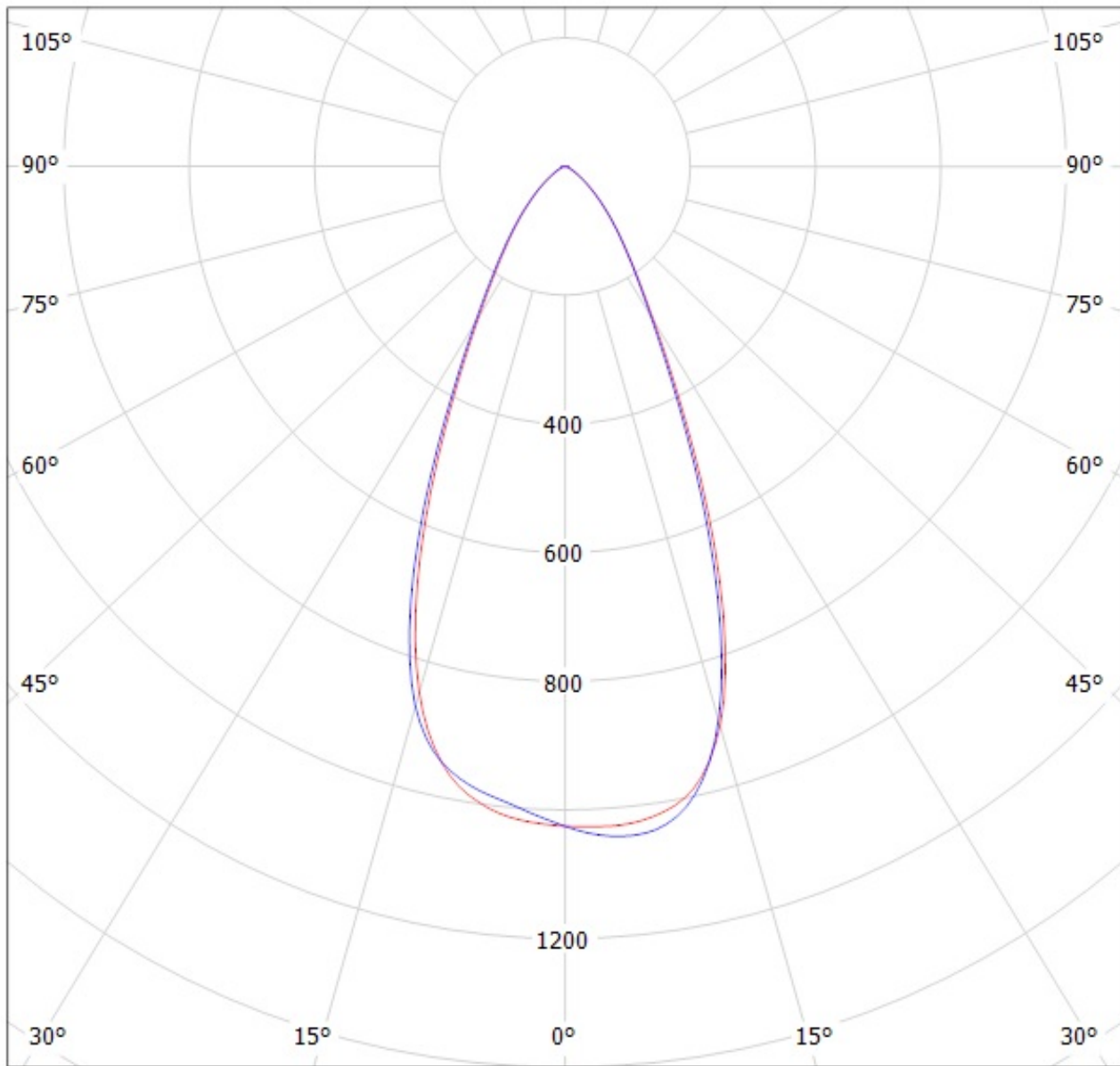

cd/klm

— C0 - C180

— C90 - C270

$\eta = 80\%$

Luminaire: LEDiL Oy CA14442_VERONICA-SQ-W_(Luxeon_T)

Lamps: 1 x Philips_Lumileds_Luxeon_T_(LXH8-FW30-3)_72.2743lm@250mA_P=0.734231W_I=0.2499A

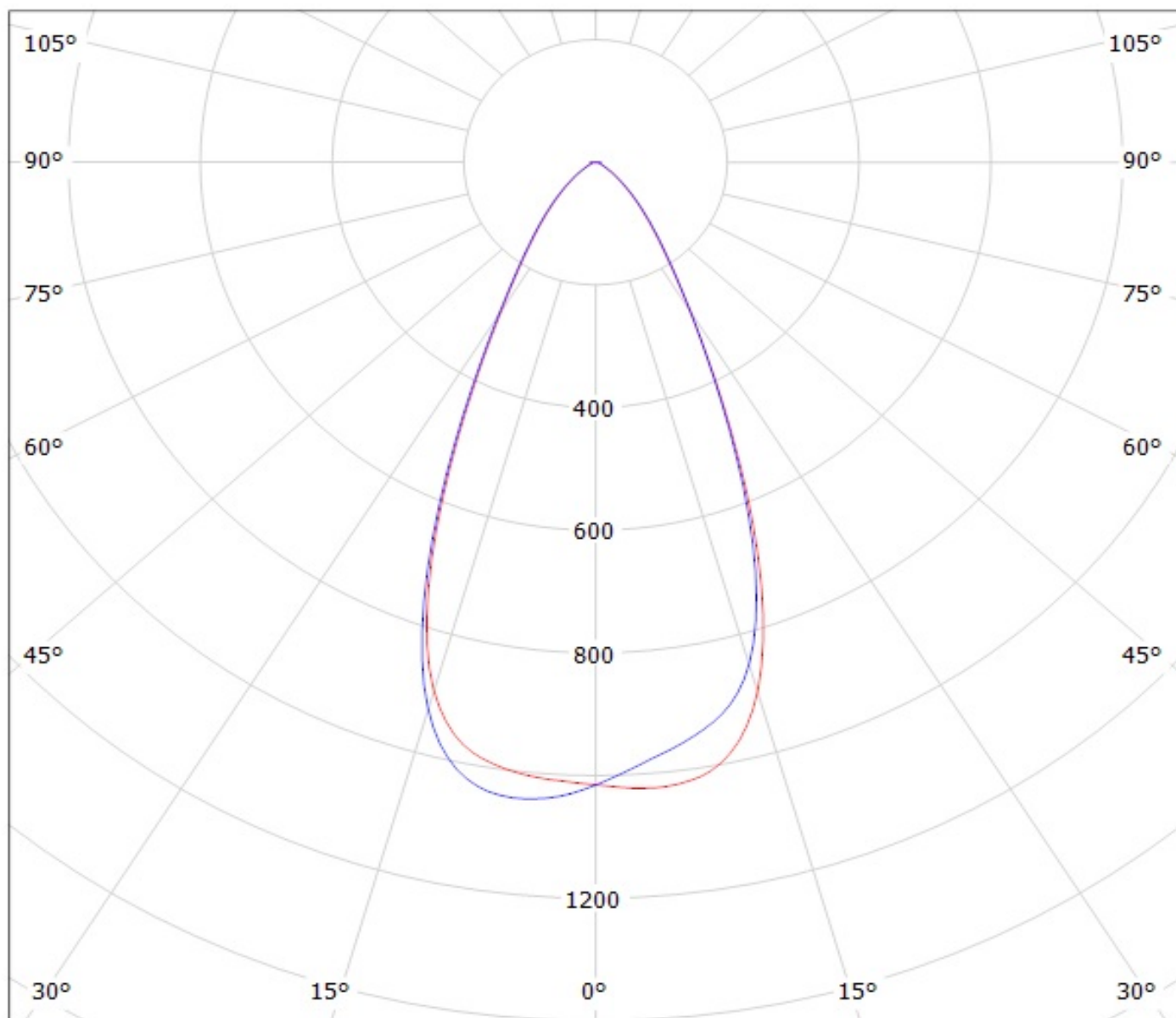

cd/klm

— C0 - C180

— C90 - C270

$\eta = 82\%$

Luminaire: LEDiL Oy CA14442_VERONICA-SQ-W_(Luxeon_TX)

Lamps: 1 x Philips_Lumileds_Luxeon_TX_(L1T2-3585)_80.8039lm@250mA_CCT=3554K_P=0.740679W_I=0.2499A

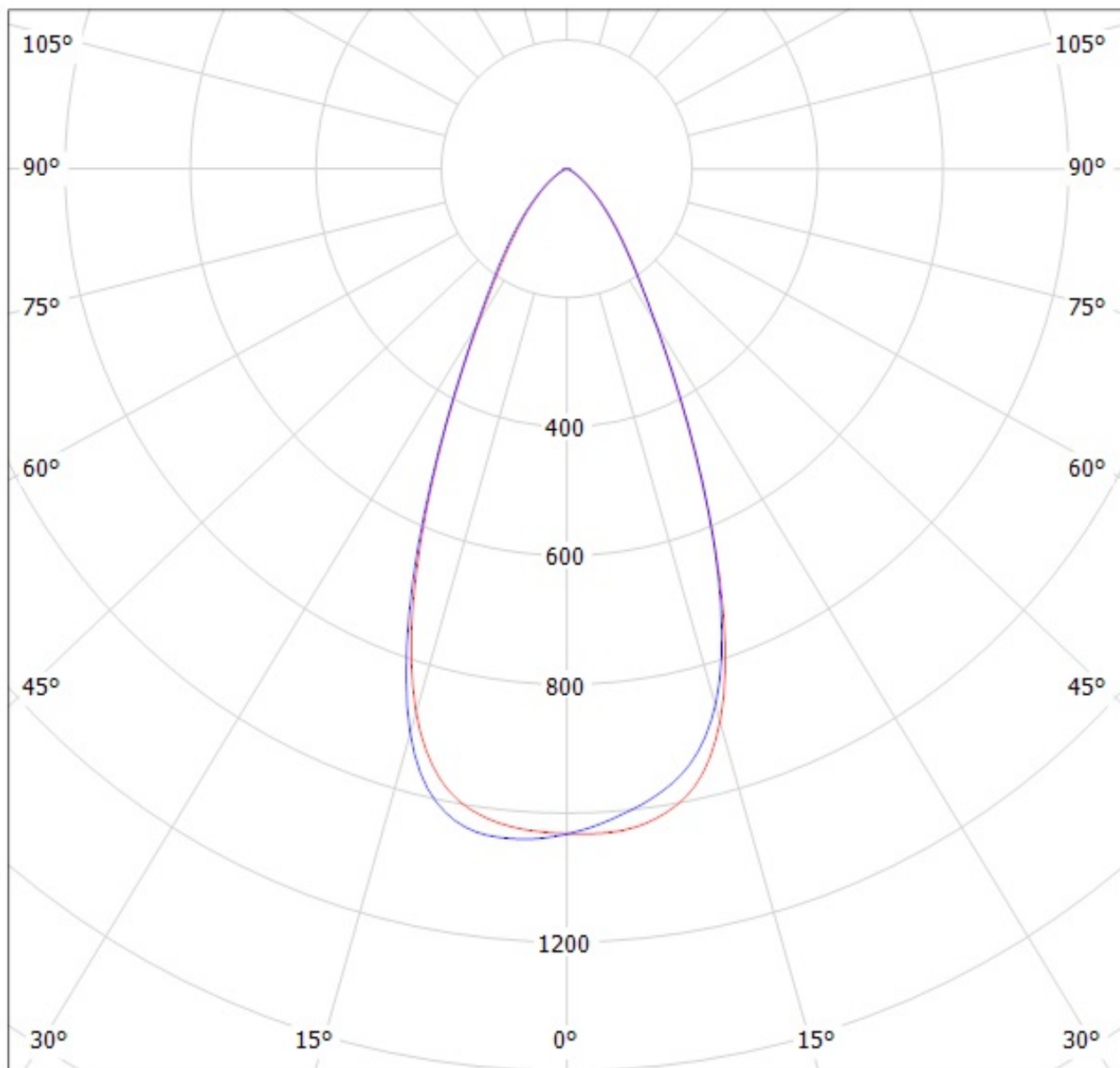

cd/klm

$\eta = 81\%$

— C0 - C180

— C90 - C270

Luminaire: LEDiL Oy CA14442_VERONICA-SQ-W_(Luxeon_Rebel_ES)

Lamps: 1 x Philips_Lumileds_Luxeon_Rebel_ES_(LXML-PWC2)_89.4472lm@250mA_P=0.746101W_I=0.2499A

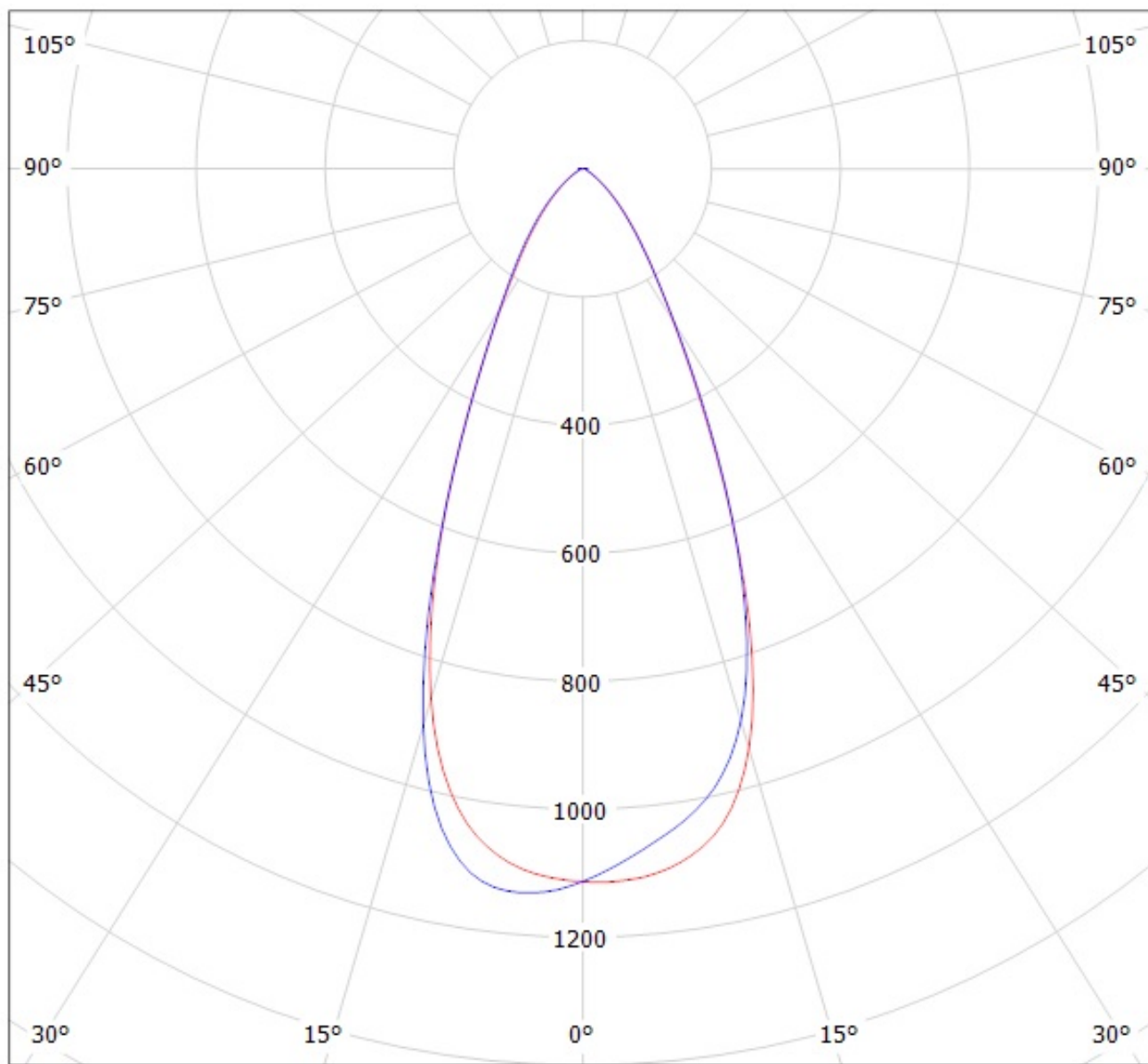

cd/klm

— C0 - C180

— C90 - C270

$\eta = 80\%$

Luminaire: LEDiL Oy CA14442_VERONICA-SQ-W_(Luxeon_A)

Lamps: 1 x Philips_Lumileds_Luxeon_A_(LXH8-PW30)_65.8365lm@250mA_P=0.727284W_I=0.2499A

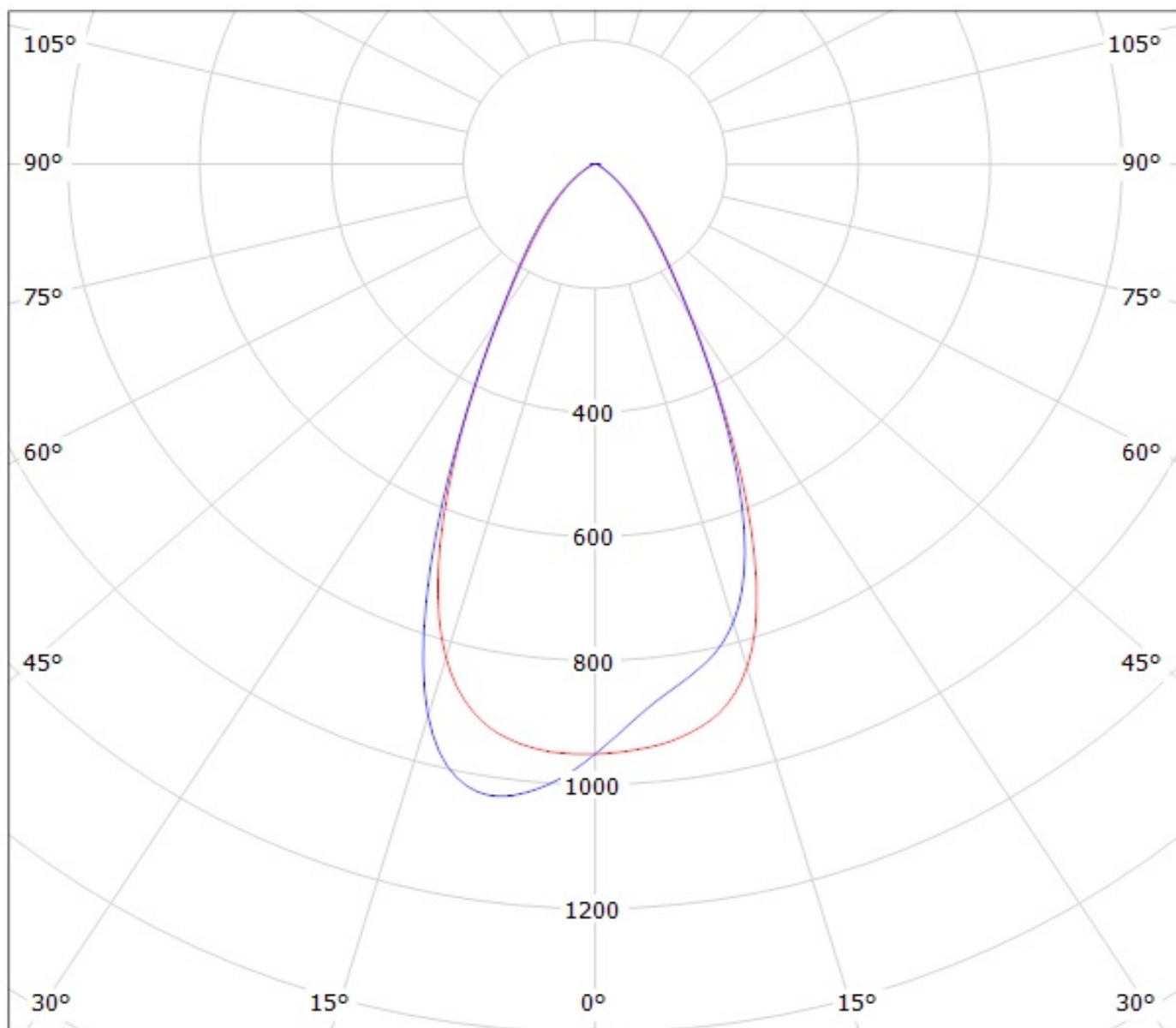

cd/klm

— C0 - C180

— C90 - C270

$\eta = 80\%$

Luminaire: LEDiL Oy CA14442_VERONICA-SQ-W_(Nichia_NVsxx19B)

Lamps: 1 x Nichia_NVsxx19B_105.826lm@250mA_P=0.731182W_I=250mA

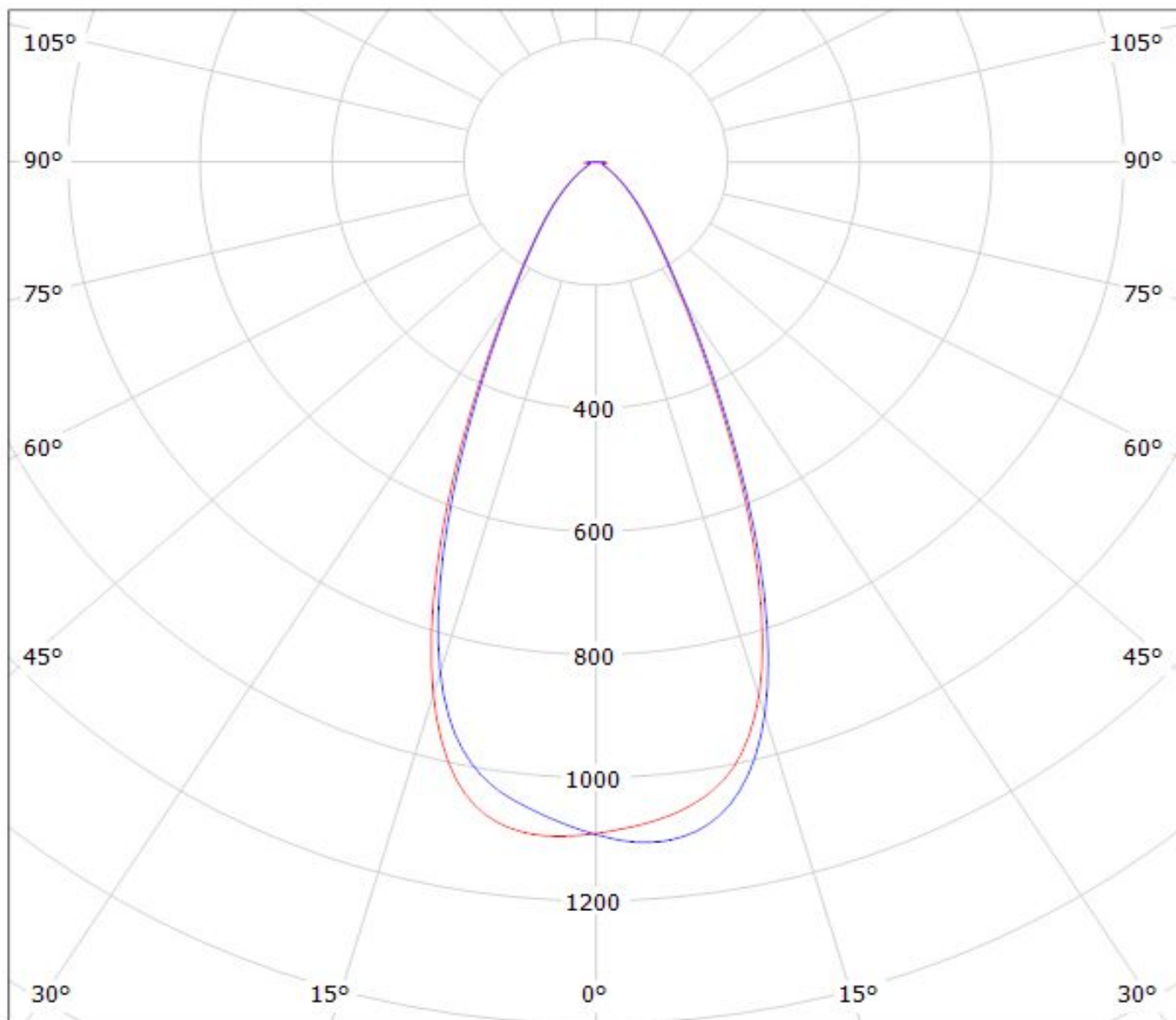

cd/klm

— C0 - C180

— C90 - C270

$\eta = 81\%$

Luminaire: LEDiL Oy CA14442_VERONICA-SQ-W_(NCSxx19B) Nichia_NCSxx19B_(NCSL219B)_76.9443lm@250mA_P=0.779638W_I=0.2499A
Lamps: 1 x Nichia_NCSxx19B_(NCSL219B)_76.9443lm@250mA_P=0.779638W_I=0.2499A

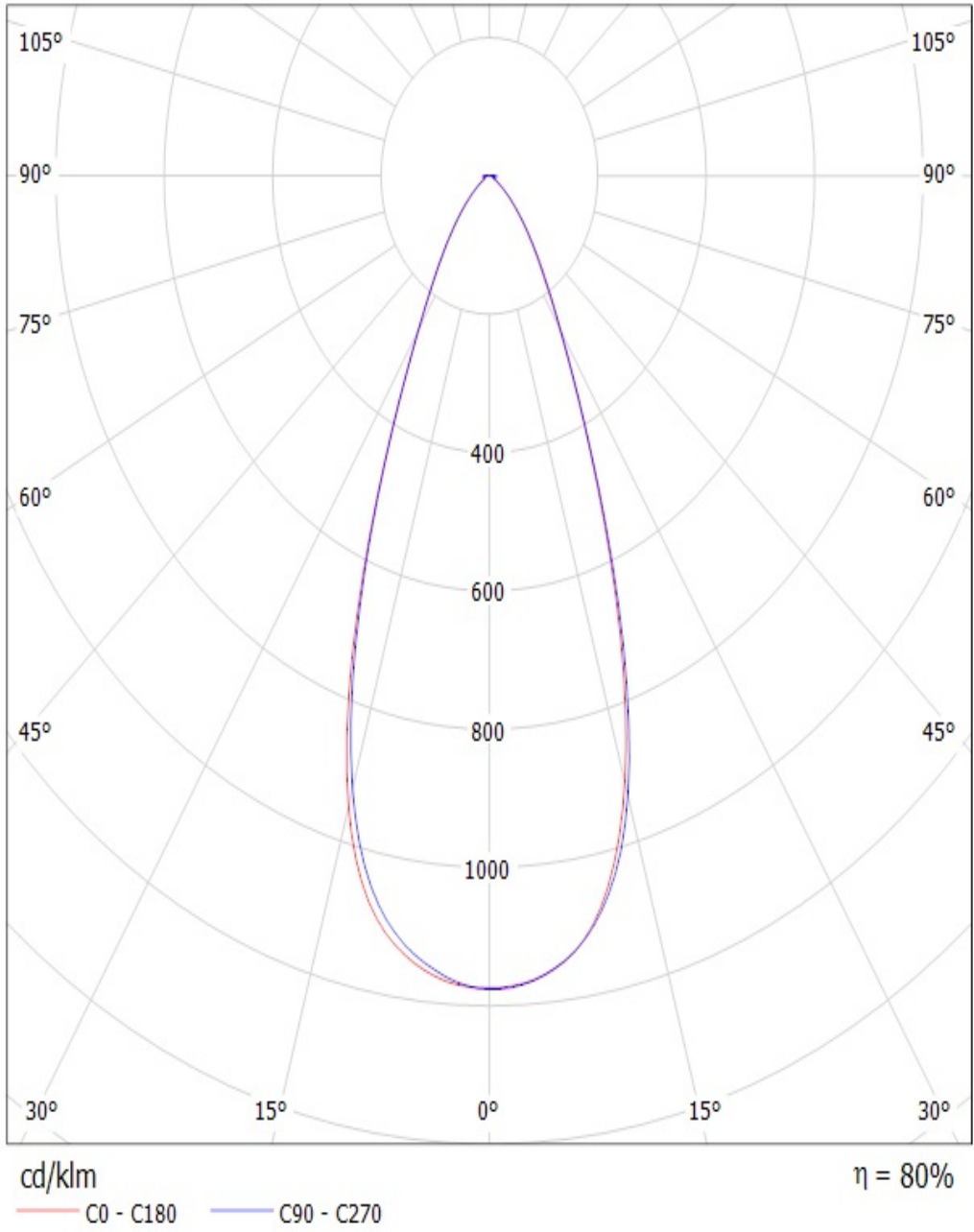

Luminaire: LEDiL Oy CA14442_VERONICA-SQ-W_(NWSL229AE)

Lamps: 1 x Nichia_NWSL229AE_120.54lm@250mA_P=0.7128W_I=0.250A

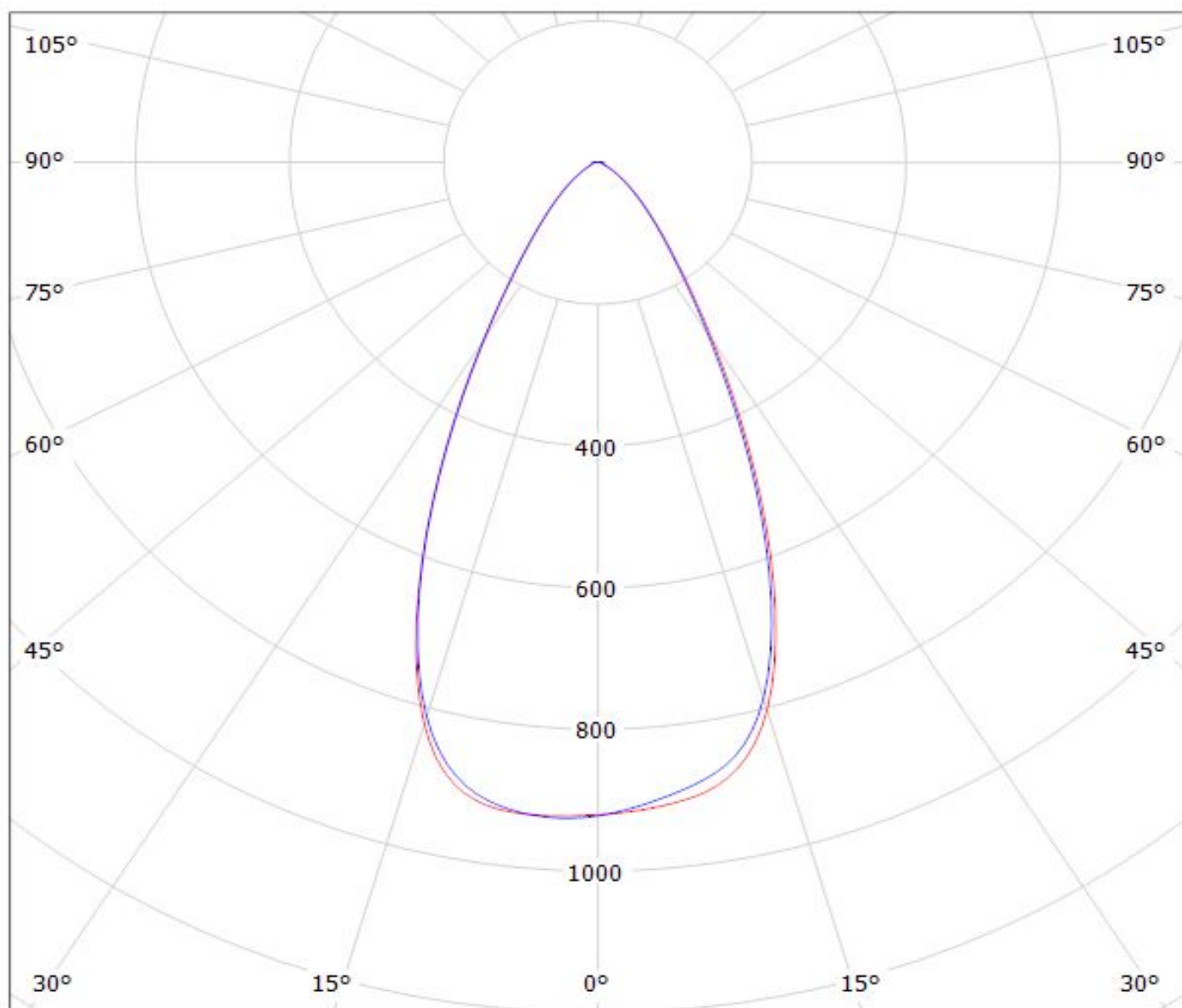

cd/klm

— C0 - C180

— C90 - C270

$\eta = 78\%$

Luminaire: LEDiL Oy CA14442_VERONICA-SQ-W_(NVSW3x9A)

Lamps: 1 x Nichia_NVSW3x9A_(sm405/R70)_122.334lm@250mA_P=0.705435W_I=0.250A

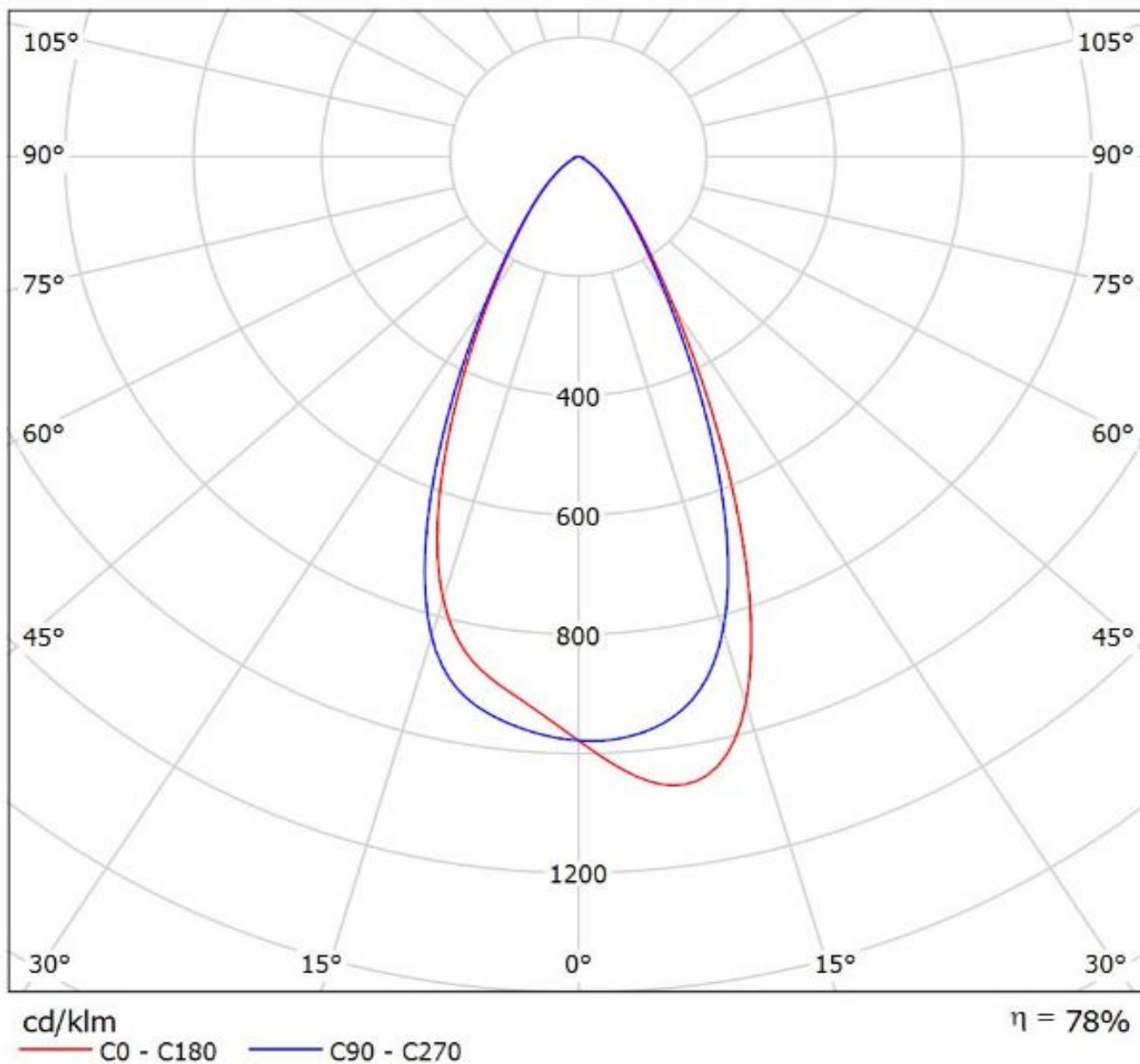

Luminaire: LEDiL Oy CA14442_VERONICA-SQ-W_(Oslon_SSL_80)

Lamps: 1 x Osram_Oslon_SSL_80_(LUW_CP7P-KTLP-5C8E-35-2)_75.7431lm@250mA_P=0.82352W_I=0.2499A

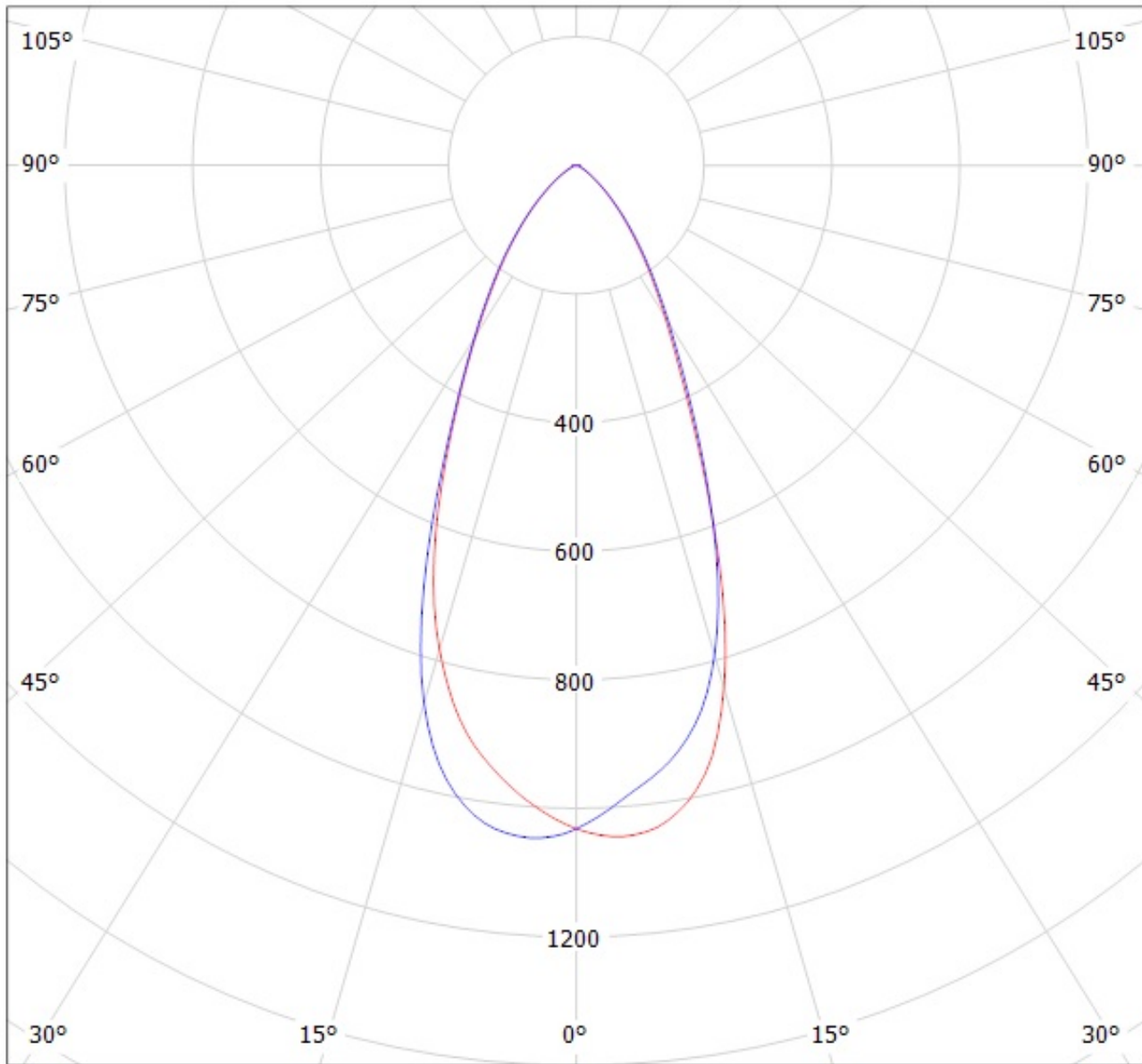

cd/klm

$\eta = 80\%$

— C0 - C180 — C90 - C270

Luminaire: LEDiL Oy CA14442_VERONICA-SQ-W_(Oslon_Square_PC)

Lamps: 1 x Osram_Oslon_Square-PC_(LCW_CQAR.PL-MSMV-5H71-1)_99.714lm@250mA_P=0.770717W_I=0.2499A

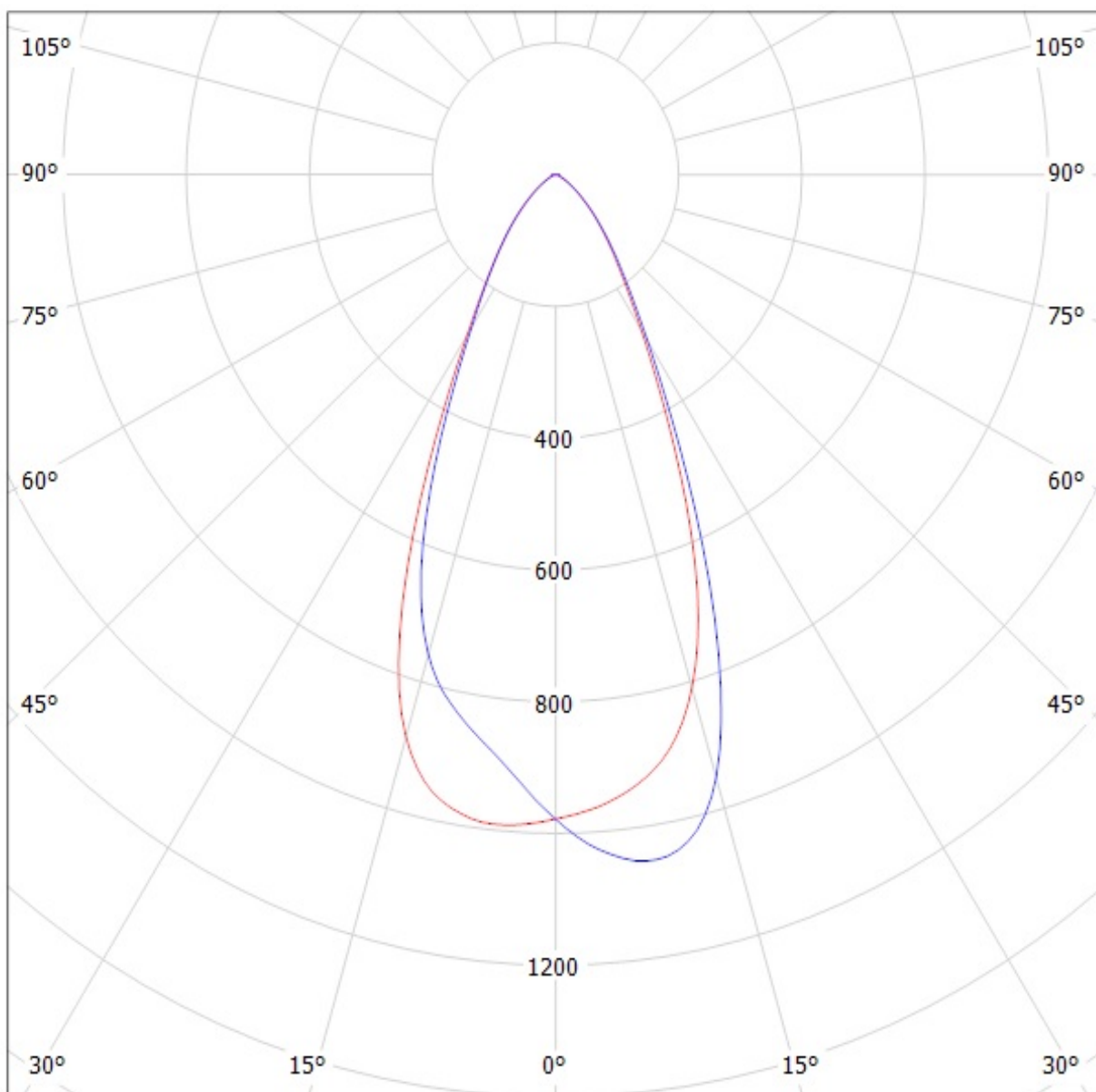

cd/klm

— C0 - C180

— C90 - C270

$\eta = 79\%$

Luminaire: LEDiL Oy CA14442_VERONICA-SQ-W_(Oslon_Square_EC)

Lamps: 1 x Osram_Oslon_Square_EC_(GW_CSSRM1.EC)_85.3477lm@250mA_P=0.738904W_I=0.2499A

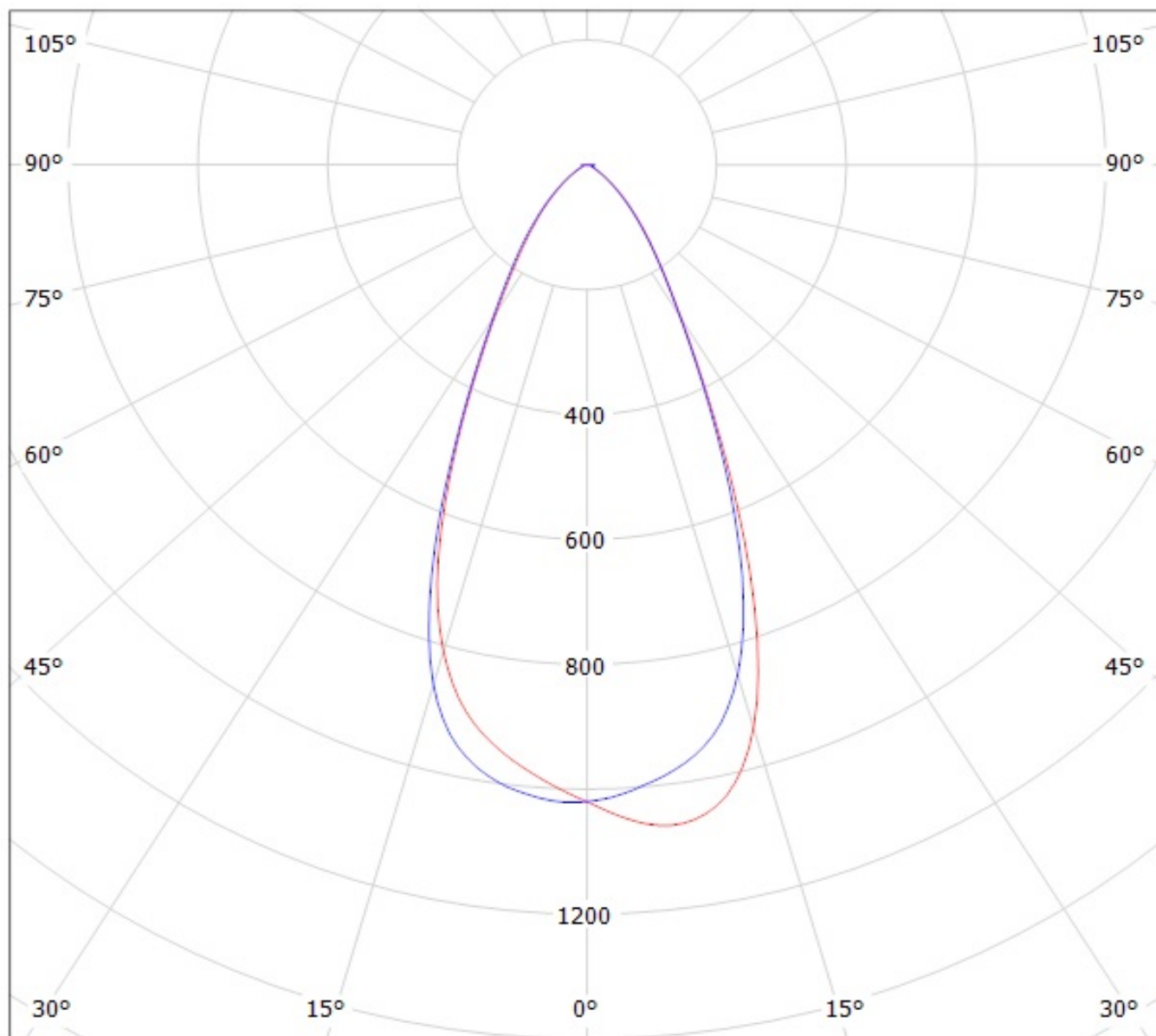

cd/klm

— C0 - C180

— C90 - C270

$\eta = 80\%$

Luminaire: Ledil Oy CA14442_VERONICA-SQ-W_(Duris_P10)_SIMULATED
Lamps: 1 x Osram Duris P10

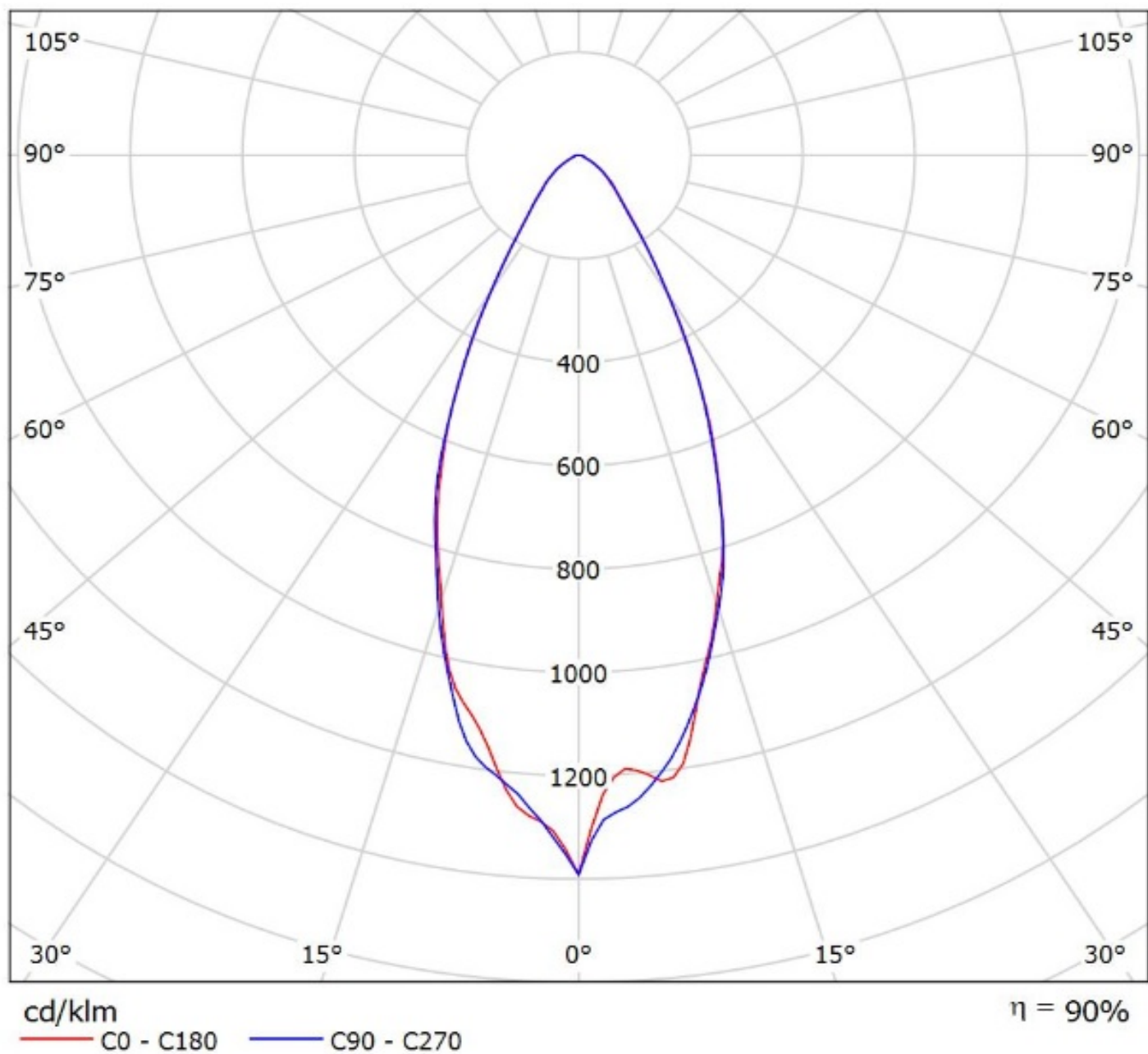

Luminaire: LEDiL Oy CA14442_VERONICA-SQ-W_(Z8Y22plus)

Lamps: 1 x Seoul_Z8Y22plus_(W6E2G)_125.652lm@250mA_P=0.69312W_I=0.250A

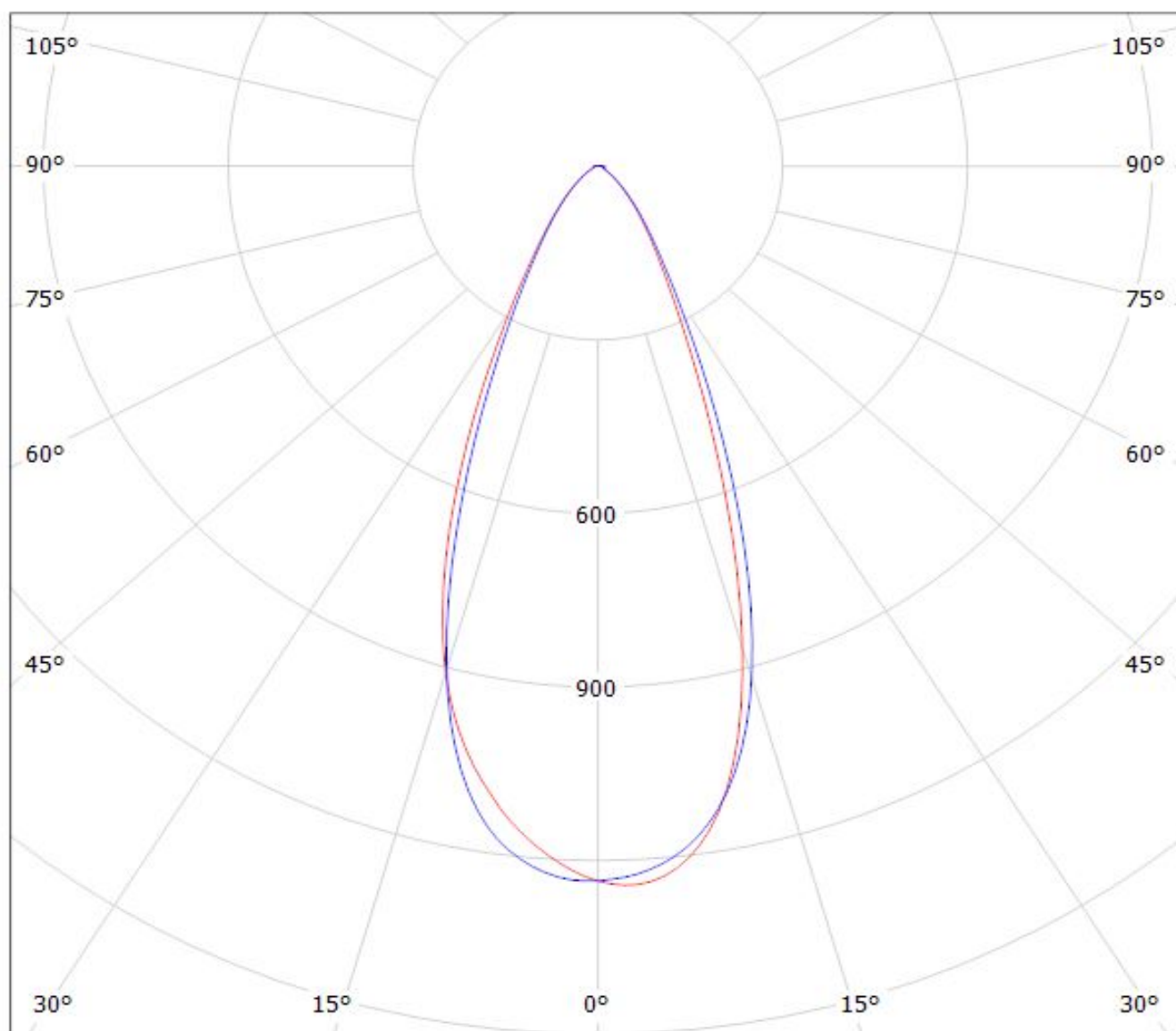

cd/klm

$\eta = 78\%$

— C0 - C180

— C90 - C270

NOTE: The typical divergence will be changed by different color, chip size and chip position tolerance. The typical total divergence is the full angle measured where the luminous intensity is half of the peak value.