



ZIF Connector & Flat Flexible Cable

03



ZIF Connector & Flat Flexible Cable







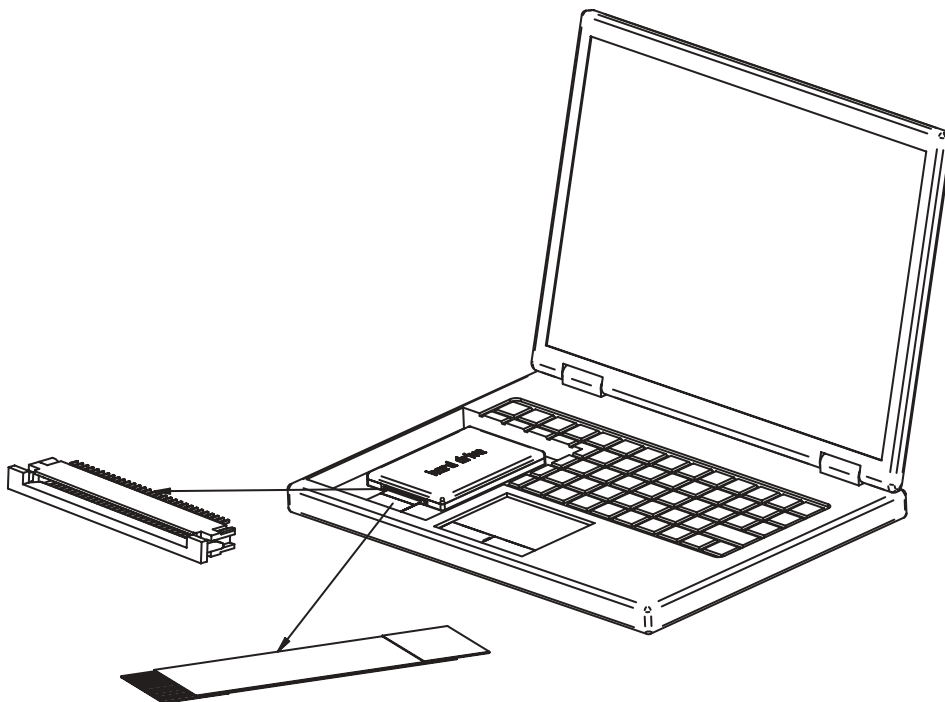



As the demand for higher density in electronic equipment increases, the use of Flexible Flat Cable (FFC) or Flexible Printed Circuits (FPC) to reduce size, weight and assembly costs has expanded. ZIF connectors are getting more and more common in several applications, specially when a connection to a small display (screen) or keyboard is needed. ZIF connectors have been developed to meet high combination of requirements like low profile, light-weight, secure and removable connection.

03

Technology: ZIF connectors are used for attaching wires to PCB inside electronic equipments. The wires, formed into a ribbon cable, are pre-stripped and the bare ends placed inside the connector. The two sliding parts of the connector are then pushed together, causing it to grip the wires. The main advantage of this system is that it does not require a mating half to be fitted to the wire ends: it's a **one connector solution**.



ZIF Connector & Flat Flexible Cable

	1.00 mm SMT ZIF Horizontal Bottom Contact	03-5
	1.00 mm SMT ZIF Horizontal Top Contact	03-6
	1.00 mm SMT ZIF Vertical Type A	03-7
	0.50 mm SMT ZIF Horizontal Bottom Contact	03-8 & 9
	0.50 mm SMT ZIF Horizontal Top Contact	03-10 & 11
	0.50 mm SMT ZIF Vertical Type A & B	03-12 & 13
	1.00 mm Flat Flexible Cable	03-14 & 15
	0.50 mm Flat Flexible Cable	03-16 & 17
	Special Request for Flat Flexible Cable	03-18
	Design Kit	03-19

NEW

03



ZIF Connector & Flat Flexible Cable

Connector/Cable	Pitch	Type	Construction	Contact design	Order Code	Page
Connector (ZIF)	Pitch 1,00 mm	HORIZONTAL	SMT	Bottom Contact	686 1xx 144 22	03-5
				Top Contact	686 1xx 141 22	03-6
	Pitch 0,50 mm	HORIZONTAL	SMT	Type A	686 1xx 124 422	03-7
				Bottom Contact	687 1xx 145 22	03-8 & 9
		VERTICAL	SMT	Type A	687 1xx 140 22	03-10 & 11
				Type B	687 1xx 124 322	03-12
Cable (FFC)	Pitch 1,00 mm	Type 1			686 6xx xxx 001	03-14
		Type 2			686 7xx xxx 001	03-15
	Pitch 0,50 mm	Type 1			687 6xx xxx 002	03-16
		Type 2			687 7xx xxx 002	03-17
	Special inquiries				tbd	03-18
	Design Kit					687 001

NEW
NEW
NEW
NEW
NEW

03



1.00mm SMT ZIF Horizontal Bottom Contact WR-FPC



HIGH TEMPERATURE



MATERIAL

- Housing material: PPS
- Flamability rating: UL94-V0
- Colour: Beige
- Actuator material: PPS
- Colour: Brown
- Contact material: Phosphor bronze
- Contact plating: 100 μ Tin over 50 μ Ni
- Quality class: 25 Mating cycles
- Pitch: 1.00 mm

ENVIRONMENTAL

- Operating temperature: -25 °C up to 85 °C
- Compliance: Lead free and RoHS

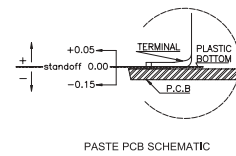
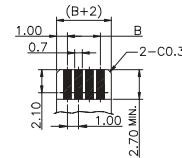
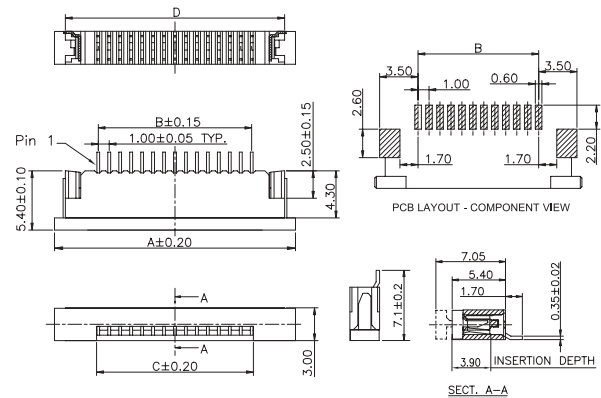

ELECTRICAL

- Current rating: 1 A
- Working voltage: 125 V
- Insulation resistance: >100 MOhm
- Dielectric withstanding voltage: 500 Vac/mn
- Contact resistance: 20 mOhm max

SOLDERING

- Solder temperature: JEDEC lead free reflow soldering

PACKAGING

- Tape & Reel

Order Code	Pins	A (mm)	B (mm)	C (mm)	D (mm)
686 104 144 22	4	11.0	3.0	5.15	9.0
686 105 144 22	5	12.0	4.0	6.10	10.0
686 106 144 22	6	13.0	5.0	7.15	11.0
686 108 144 22	8	15.0	7.0	9.15	13.0
686 109 144 22	9	16.0	8.0	10.10	14.0
686 110 144 22	10	17.0	9.0	11.15	15.0
686 112 144 22	12	19.0	11.0	13.15	17.0
686 114 144 22	14	21.0	13.0	15.15	19.0
686 116 144 22	16	23.0	15.0	17.15	21.0
686 118 144 22	18	25.0	17.0	19.15	23.0
686 120 144 22	20	27.0	19.0	21.15	25.0
686 122 144 22	22	29.0	21.0	23.15	27.0
686 124 144 22	24	31.0	23.0	25.15	29.0
686 126 144 22	26	33.0	25.0	27.15	31.0
686 128 144 22	28	36.0	28.0	30.15	34.0
686 130 144 22	30	37.0	29.0	31.15	35.0



1.00mm SMT ZIF Horizontal Top Contact WR-FPC



HIGH TEMPERATURE

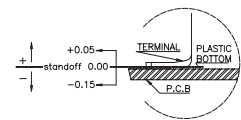
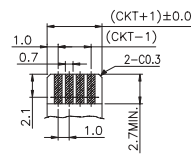
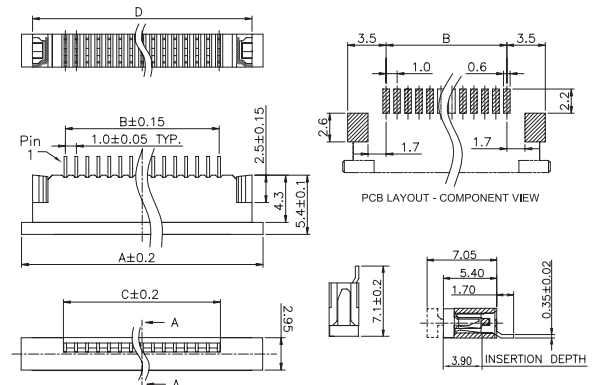

PASTE PCB SCHEMATIC

APPLICABLE FFC LAYOUT (THICKNESS: 0.3 ± 0.05)



MATERIAL

- Housing material: PPS
- Flamability rating: UL94-V0
- Colour: Beige
- Actuator material: PPS
- Colour: Brown
- Contact material: Phosphor bronze
- Contact plating: 100µ Tin over 50µ Ni
- Quality class: 25 Mating cycles
- Pitch: 1.00 mm

ENVIRONMENTAL

- Operating temperature: -25 °C up to 85 °C
- Compliance: Lead free and RoHS

ELECTRICAL

- Current rating: 1 A
- Working voltage: 125 V
- Insulation resistance: >100 MOhm
- Dielectric withstanding voltage: 500 Vac/mn
- Contact resistance: 20 mOhm max

SOLDERING

- Solder temperature: JEDEC lead free reflow soldering

PACKAGING

- Tape & Reel

Order Code	Pins	A (mm)	B (mm)	C (mm)	D (mm)
686 104 141 22	4	11.0	3.0	5.15	9.0
686 106 141 22	6	13.0	5.0	7.15	11.0
686 108 141 22	8	15.0	7.0	9.15	13.0
686 110 141 22	10	17.0	9.0	11.15	15.0
686 111 141 22	11	18.0	10.0	12.15	16.0
686 112 141 22	12	19.0	11.0	13.15	17.0
686 114 141 22	14	21.0	13.0	15.15	19.0
686 115 141 22	15	22.0	14.0	12.15	20.0
686 116 141 22	16	23.0	15.0	17.15	21.0
686 118 141 22	18	25.0	17.0	19.15	23.0
686 120 141 22	20	27.0	19.0	21.15	25.0
686 122 141 22	22	29.0	21.0	23.15	27.0
686 124 141 22	24	31.0	23.0	25.15	29.0
686 126 141 22	26	33.0	25.0	27.15	31.0
686 128 141 22	28	36.0	28.0	30.15	34.0
686 130 141 22	30	37.0	29.0	31.15	35.0

1.00mm SMT ZIF Vertical Type A WR-FPC



HIGH TEMPERATURE



MATERIAL

- Housing material: LCP
- Flammability rating: UL94-V0
- Colour: Ivory
- Actuator material: LCP
- Colour: Black
- Contact material: Phosphor bronze
- Contact plating: 100µ Tin over 50µ Ni
- Quality class: 25 Mating cycles
- Pitch: 1.00 mm

ENVIRONMENTAL

- Operating temperature: -25 °C up to 85 °C
- Compliance: Lead free and RoHS

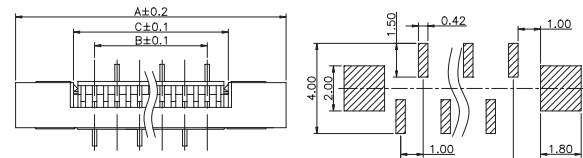

PCB LAYOUT - COMPONENT VIEW

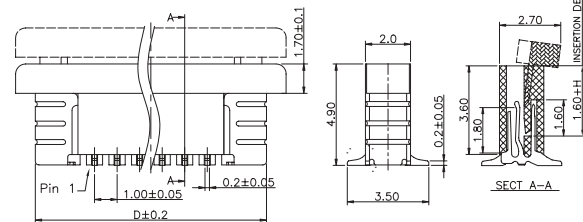

SECT A-A

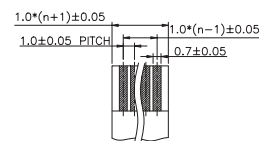

APPLICABLE FFC LAYOUT (THICKNESS: 0.3 ± 0.05)

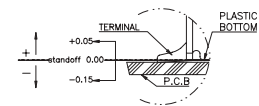

PASTE PCB SCHEMATIC

ELECTRICAL

- Current rating: 1 A
- Working voltage: 125 V
- Insulation resistance: >100 MOhm
- Dielectric withstanding voltage: 500 Vac/mm
- Contact resistance: 20 mOhm max

SOLDERING

- Solder temperature: JEDEC lead free reflow soldering

PACKAGING

- Tape & Reel

Order Code	Pins	A (mm)	B (mm)	C (mm)	D (mm)
686 104 124 422	4	10.0	3.0	5.0	8.85
686 106 124 422	6	12.0	5.0	7.0	10.85
686 108 124 422	8	14.0	7.0	9.0	12.85
686 110 124 422	10	16.0	9.0	11.0	14.85
686 112 124 422	12	18.0	11.0	13.0	16.85
686 114 124 422	14	20.0	13.0	15.0	18.85
686 116 124 422	16	22.0	15.0	17.0	20.85
686 118 124 422	18	24.0	17.0	19.0	22.85
686 120 124 422	20	26.0	19.0	21.0	24.85
686 122 124 422	22	28.0	21.0	23.0	26.85
686 124 124 422	24	30.0	23.0	25.0	28.85
686 128 124 422	28	34.0	27.0	29.0	32.85



0.5mm SMT ZIF Horizontal Bottom Contact WR-FPC

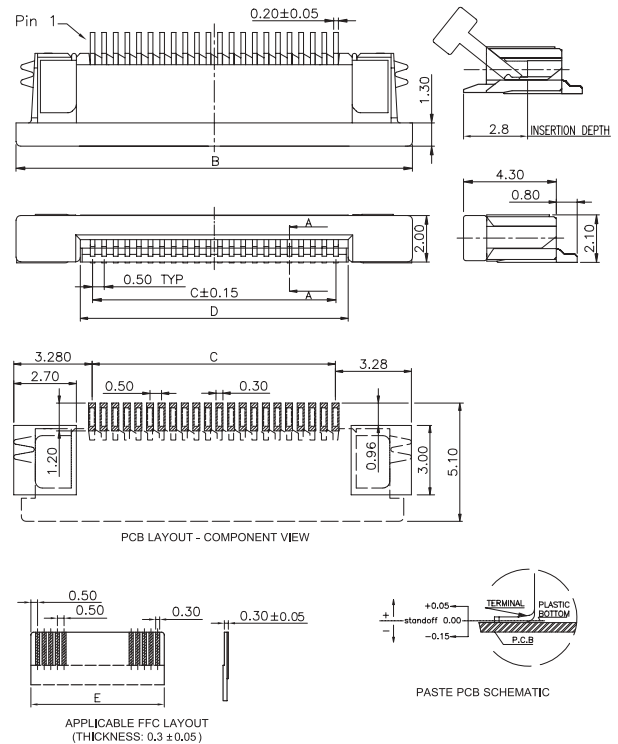

HIGH TEMPERATURE



MATERIAL

- Housing material: LCP
- Flamability rating: UL94-V0
- Colour: Ivory
- Actuator material: LCP
- Colour: Black
- Contact material: Phosphor bronze
- Contact plating: 100μ Tin over 50μ Ni
- Quality class: 25 Mating cycles
- Pitch: 0.50 mm

ENVIRONMENTAL

- Operating temperature: $-25\text{ }^\circ\text{C}$ up to $85\text{ }^\circ\text{C}$
- Compliance: Lead free and RoHS

ELECTRICAL

- Current rating: 0.4 A
- Working voltage: 50 V
- Insulation resistance: $>100\text{ MOhm}$
- Dielectric withstanding voltage: 250 Vac/mn
- Contact resistance: 20 mOhm max

SOLDERING

- Solder temperature: JEDEC lead free reflow soldering

PACKAGING

- Tape & Reel

See table on the next page >



0.5mm SMT ZIF Horizontal Bottom Contact WR-FPC

03

Order Code	Pins	B (mm)	C (mm)	D (mm)	E (mm)
687 104 145 22	4	8.4	1.5	2.6	2.5
687 106 145 22	6	9.4	2.5	3.6	3.5
687 108 145 22	8	10.4	3.5	4.6	4.5
687 110 145 22	10	11.4	4.5	5.6	5.5
687 112 145 22	12	12.4	5.5	6.6	6.5
687 114 145 22	14	13.4	6.5	7.6	7.5
687 116 145 22	16	14.4	7.5	8.6	8.5
687 117 145 22	17	15.0	8.0	9.1	9.0
687 118 145 22	18	15.4	8.5	9.6	9.5
687 120 145 22	20	16.4	9.5	10.6	10.5
687 122 145 22	22	17.4	10.5	11.6	11.5
687 124 145 22	24	18.4	11.5	12.6	12.5
687 126 145 22	26	19.4	12.5	13.6	13.5
687 128 145 22	28	20.4	13.5	14.6	14.5
687 130 145 22	30	21.4	14.4	15.6	15.5
687 133 145 22	33	23.0	16.0	17.1	17.0
687 134 145 22	34	23.5	16.5	17.6	17.5
687 135 145 22	35	24.0	17.0	18.1	18.0
687 140 145 22	40	26.4	19.5	20.6	20.5
687 144 145 22	44	28.4	21.5	22.6	22.5
687 145 145 22	45	29.0	22.0	23.1	23.0
687 150 145 22	50	31.4	24.5	25.6	25.5

0.5mm SMT ZIF Horizontal Top Contact WR-FPC

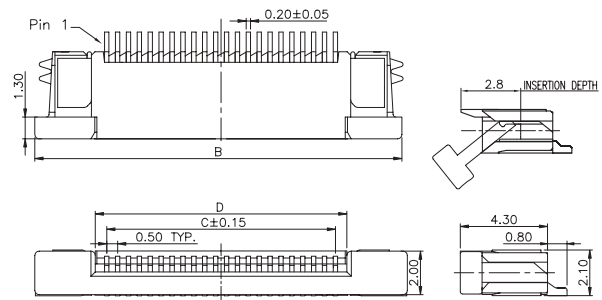

HIGH TEMPERATURE

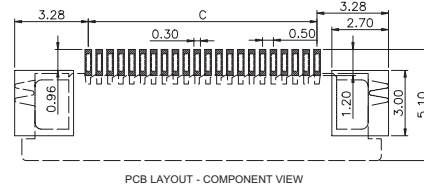

PCB LAYOUT - COMPONENT VIEW

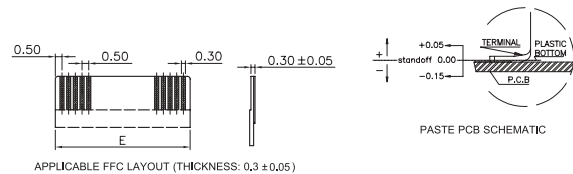

APPLICABLE FFC LAYOUT (THICKNESS: 0,3 ±0,05)

PASTE PCB SCHEMATIC



MATERIAL

- Housing material: LCP
- Flamability rating: UL94-V0
- Colour: Ivory
- Actuator material: LCP
- Colour: Black
- Contact material: Phosphor bronze
- Contact plating: 100µ Tin over 50µ Ni
- Quality class: 25 Mating cycles
- Pitch: 0.50 mm

ENVIRONMENTAL

- Operating temperature: -25 °C up to 85 °C
- Compliance: Lead free and RoHS

ELECTRICAL

- Current rating: 0.4 A
- Working voltage: 50 V
- Insulation resistance: >100 MOhm
- Dielectric withstanding voltage: 250 Vac/mn
- Contact resistance: 20 mOhm max

SOLDERING

- Solder temperature: JEDEC lead free reflow soldering

PACKAGING

- Tape & Reel



0.5mm SMT ZIF Horizontal Top Contact WR-FPC

03

Order Code	Pins	B (mm)	C (mm)	D (mm)	E (mm)
687 104 140 22	4	8.4	1.5	2.6	2.5
687 106 140 22	6	9.4	2.5	3.6	3.5
687 108 140 22	8	10.4	3.5	4.6	4.5
687 110 140 22	10	11.4	4.5	5.6	5.5
687 112 140 22	12	12.4	5.5	6.6	6.5
687 114 140 22	14	13.4	6.5	7.6	7.5
687 116 140 22	16	14.4	7.5	8.6	8.5
687 117 140 22	17	15.0	8.0	9.1	9.0
687 118 140 22	18	15.4	8.5	9.6	9.5
687 120 140 22	20	16.4	9.5	10.6	10.5
687 122 140 22	22	17.4	10.5	11.6	11.5
687 124 140 22	24	18.4	11.5	12.6	12.5
687 125 140 22	25	19.0	12.0	13.1	13.0
687 126 140 22	26	19.4	12.5	13.6	13.5
687 128 140 22	28	20.4	13.5	14.6	14.5
687 130 140 22	30	21.4	14.4	15.6	15.5
687 132 140 22	32	22.5	15.5	16.6	16.5
687 133 140 22	33	23.0	16.0	17.1	17.0
687 134 140 22	34	23.5	16.5	17.6	17.5
687 135 140 22	35	24.0	17.0	18.1	18.0
687 140 140 22	40	26.4	19.5	20.6	20.5
687 144 140 22	44	28.5	21.5	22.6	22.5
687 145 140 22	45	29.0	22.0	23.1	23.0
687 150 140 22	50	31.4	24.5	25.6	25.5



0.50mm SMT ZIF Vertical Type A WR-FPC



HIGH TEMPERATURE



MATERIAL

- Housing material: LCP
- Flamability rating: UL94-V0
- Colour: Ivory
- Actuator material: LCP
- Colour: Black
- Contact material: Phosphor bronze
- Contact plating: 100 μ Tin over 50 μ Ni
- Quality class: 25 Mating cycles
- Pitch: 0.50 mm

ENVIRONMENTAL

- Operating temperature: -25 °C up to 85 °C
- Compliance: Lead free and RoHS

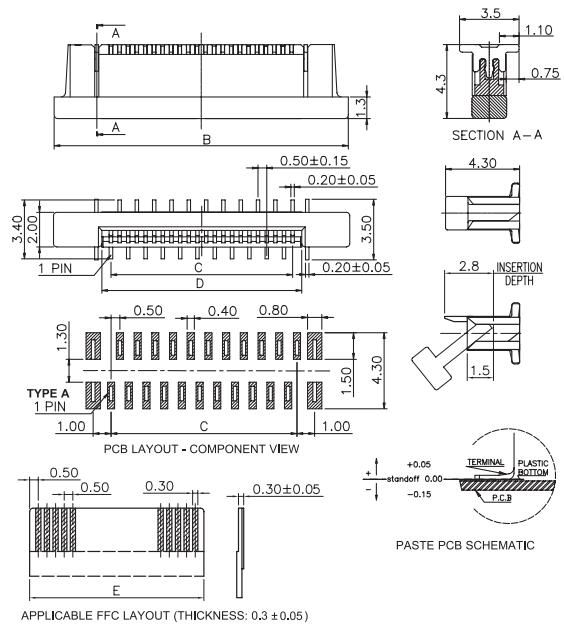

ELECTRICAL

- Current rating: 0.4 A
- Working voltage: 50 V
- Insulation resistance: >100 MOhm
- Dielectric withstanding voltage: 250 Vac/mn
- Contact resistance: 20 mOhm max

SOLDERING

- Solder temperature: JEDEC lead free reflow soldering

PACKAGING

- Tape & Reel

Order Code	Pins	B (mm)	C (mm)	D (mm)	E (mm)
687 104 124 422	4	8.4	1.5	2.6	2.5
687 106 124 422	6	9.4	2.5	3.6	3.5
687 108 124 422	8	10.4	3.5	4.6	4.5
687 110 124 422	10	11.4	4.5	5.6	5.5
687 112 124 422	12	12.4	5.5	6.6	6.5
687 114 124 422	14	13.4	6.5	7.6	7.5
687 116 124 422	16	14.4	7.5	8.6	8.5
687 118 124 422	18	15.4	8.5	9.6	9.5
687 120 124 422	20	16.4	9.5	10.6	10.5
687 122 124 422	22	17.4	10.5	11.6	11.5
687 124 124 422	24	18.4	11.5	12.6	12.5
687 126 124 422	26	19.4	12.5	13.6	13.5
687 128 124 422	28	20.4	13.5	14.6	14.5
687 130 124 422	30	21.4	14.4	15.6	15.5
687 134 124 422	34	23.4	16.5	17.6	17.5
687 140 124 422	40	26.4	19.5	20.6	20.5
687 150 124 422	50	31.4	24.5	25.6	25.5

0.50mm SMT ZIF Vertical Type B WR-FPC



HIGH TEMPERATURE



MATERIAL

- Housing material: LCP
- Flamability rating: UL94-V0
- Colour: Ivory
- Actuator material: LCP
- Colour: Black
- Contact material: Phosphor bronze
- Contact plating: 100µ Tin over 50µ Ni
- Quality class: 25 Mating cycles
- Pitch: 0.50 mm

ENVIRONMENTAL

- Operating temperature: -25 °C up to 85 °C
- Compliance: Lead free and RoHS

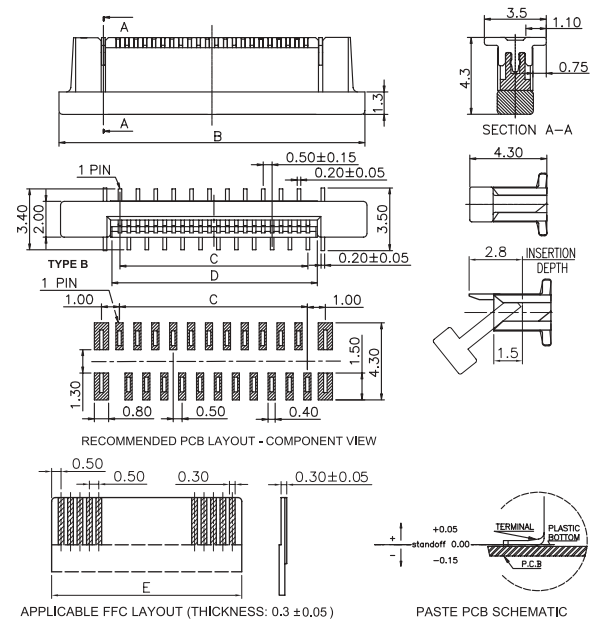

ELECTRICAL

- Current rating: 0.4 A
- Working voltage: 50 V
- Insulation resistance: >100 MOhm
- Dielectric withstanding voltage: 250 Vac/mn
- Contact resistance: 20 mOhm max

SOLDERING

- Solder temperature: JEDEC lead free reflow soldering

PACKAGING

- Tape & Reel

Order Code	Pins	B (mm)	C (mm)	D (mm)	E (mm)
687 104 124 322	4	8.4	1.5	2.6	2.5
687 106 124 322	6	9.4	2.5	3.6	3.5
687 108 124 322	8	10.4	3.5	4.6	4.5
687 110 124 322	10	11.4	4.5	5.6	5.5
687 112 124 322	12	12.4	5.5	6.6	6.5
687 114 124 322	14	13.4	6.5	7.6	7.5
687 116 124 322	16	14.4	7.5	8.6	8.5
687 118 124 322	18	15.4	8.5	9.6	9.5
687 120 124 322	20	16.4	9.5	10.6	10.5
687 122 124 322	22	17.4	10.5	11.6	11.5
687 124 124 322	24	18.4	11.5	12.6	12.5
687 126 124 322	26	19.4	12.5	13.6	13.5
687 128 124 322	28	20.4	13.5	14.6	14.5
687 130 124 322	30	21.4	14.4	15.6	15.5
687 140 124 322	40	26.4	19.5	20.6	20.5
687 150 124 322	50	31.4	24.5	25.6	25.5



EXTENDED RANGE

1.00mm Flat Flexible Cable Type 1 WR-FPC

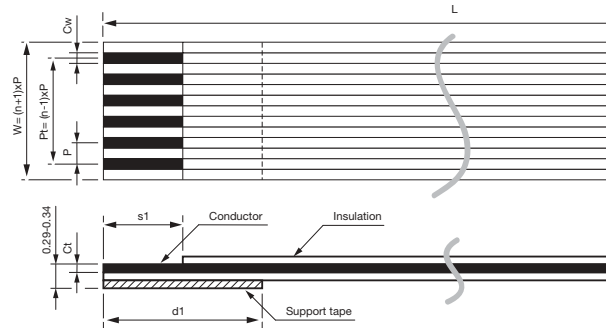
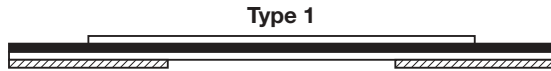

03



MATERIAL

- Insulation: PET (White)
- Support tape: PET (Blue)
- Flamability rating: UL Sub.758
- Contact material: Copper
- Contact plating: Tin
- Quality class: 20 Mating cycles minimum
- Pitch: 1.00 mm

ENVIRONMENTAL

- Operating temperature: -30 °C up to 105 °C
- Heat resistance: 85°C x 95Hrs
- Moisture resistance: 40°C, 95% RH x 96Hrs
- Compliance: Lead free and RoHS

MECHANICAL

- Elongation of insulator: More than 60 %

- Tensile strenght of insulation: More than 3.5kg/mm²
- Flexig test: 180° More than 20 times
- Abrasion: More than 10.000times
- Pull/Out: More than 20 times

ELECTRICAL

- Working voltage: 60V
- Current rating: 1 A
- Insulation resistance: 500 Vdc more than 1.000 MOhm
- Dielectric strenght: 500 Vac/1mn No breakdown
- Conductor resistance: Less than 0.33Ohm/m
- Contact resistance: 20 mOhm max

PACKAGING

Bag

Order Code	Pins	Length (mm)	Ct (mm)	Cw (mm)	W (mm)	Pt (mm)	P (mm)	d1 (mm)	s1 (mm)
686 604 xxx 001	4	xxx = 050 Length 50mm	0.100	0.7	(n+1) x 1.0	(n-1) x 1.0	1.0	10.0	5.0
686 605 xxx 001	5								
686 606 xxx 001	6								
686 608 xxx 001	8								
686 609 xxx 001	9								
686 610 xxx 001	10								
686 611 xxx 001	11								
686 612 xxx 001	12								
686 614 xxx 001	14								
686 615 xxx 001	15								
686 616 xxx 001	16	xxx = 152 Length 152mm	0.100	0.7	(n+1) x 1.0	(n-1) x 1.0	1.0	10.0	5.0
686 618 xxx 001	18								
686 620 xxx 001	20								
686 621 xxx 001	21								
686 622 xxx 001	22								
686 624 xxx 001	24								
686 626 xxx 001	26								
686 628 xxx 001	28								
686 630 xxx 001	30								

EXTENDED
RANGE

1.00mm Flat Flexible Cable Type 2 WR-FPC

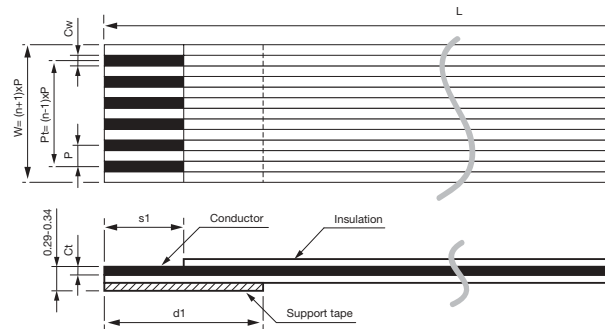
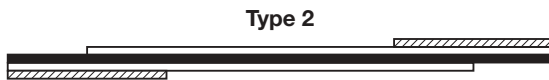

03



MATERIAL

- Insulation: PET (White)
- Support tape: PET (Blue)
- Flammability rating: UL Sub.758
- Contact material: Copper
- Contact plating: Tin
- Quality class: 20 Mating cycles minimum
- Pitch: 1.00 mm

ENVIRONMENTAL

- Operating temperature: -30 °C up to 105 °C
- Heat resistance: 85°C x 95Hrs
- Moisture resistance: 40°C, 95% RH x 96Hrs
- Compliance: Lead free and RoHS

MECHANICAL

- Elongation of insulator: More than 60 %

- Tensile strength of insulation: More than 3.5kg/mm²
- Flexig test: 180° More than 20 times
- Abrasion: More than 10.000times
- Pull/Out: More than 20 times

ELECTRICAL

- Working voltage: 60V
- Current rating: 1 A
- Insulation resistance: 500 Vdc more than 1.000 MOhm
- Dielectric strength: 500 Vac/1mm No breakdown
- Conductor resistance: Less than 0.33Ohm/m
- Contact resistance: 20 mOhm max

PACKAGING

Bag

Order Code	Pins	Length (mm)	Ct (mm)	Cw (mm)	W (mm)	Pt (mm)	P (mm)	d1 (mm)	s1 (mm)
686 704 xxx 001	4	xxx = 050 Length 50mm	0.100	0.7	(n+1) x 1.0	(n-1) x 1.0	1.0	10.0	5.0
686 705 xxx 001	5								
686 706 xxx 001	6								
686 708 xxx 001	8								
686 709 xxx 001	9								
686 710 xxx 001	10								
686 711 xxx 001	11								
686 712 xxx 001	12								
686 714 xxx 001	14								
686 715 xxx 001	15								
686 716 xxx 001	16	xxx = 100 Length 100mm	0.100	0.7	(n+1) x 1.0	(n-1) x 1.0	1.0	10.0	5.0
686 718 xxx 001	18								
686 720 xxx 001	20								
686 721 xxx 001	21								
686 722 xxx 001	22								
686 724 xxx 001	24								
686 726 xxx 001	26								
686 728 xxx 001	28								
686 730 xxx 001	30								



EXTENDED RANGE

0.50mm Flat Flexible Cable Type 1 WR-FPC

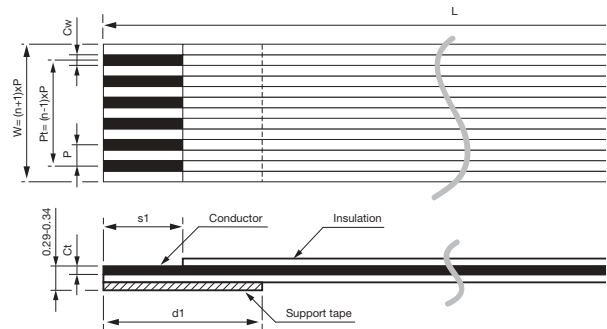
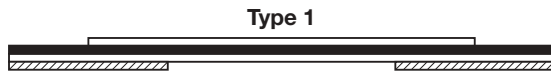

03



MATERIAL

- Insulation: PET (White)
- Support tape: PET (Blue)
- Flammability rating: UL Sub.758
- Contact material: Copper
- Contact plating: Tin
- Quality class: 20 Mating cycles minimum
- Pitch: 0.50 mm

- Tensile strength of insulation: More than 3.5kg/mm²
- Flexig test: 180° More than 20 times
- Abrasion: More than 10.000times
- Pull/Out: More than 20 times

ENVIRONMENTAL

- Operating temperature: -30 °C up to 105 °C
- Heat resistance: 85°C x 95Hrs
- Moisture resistance: 40°C, 95% RH x 96Hrs
- Compliance: Lead free and RoHS

ELECTRICAL

- Working voltage: 60V
- Current rating: 0.5 A
- Insulation resistance: 500 Vdc more than 1.000 MOhm
- Dielectric strength: 500 Vac/1mm No breakdown
- Conductor resistance: Less than 2.20Ohm/m
- Contact resistance: 20 mOhm max

MECHANICAL

- Elongation of insulator: More than 60 %

PACKAGING

Bag

Order Code	Pins	Length (mm)	Ct (mm)	Cw (mm)	W (mm)	Pt (mm)	P (mm)	d1 (mm)	s1 (mm)
687 606 xxx 002	6								
687 608 xxx 002	8								
687 610 xxx 002	10								
687 612 xxx 002	12								
687 614 xxx 002	14								
687 616 xxx 002	16								
687 617 xxx 002	17								
687 618 xxx 002	18								
687 620 xxx 002	20	xxx = 050 Length 50mm							
687 622 xxx 002	22								
687 624 xxx 002	24	xxx = 100 Length 100mm							
687 625 xxx 002	25		0.035	0.3	(n+1) x 0.5	(n-1) x 0.5	0.5	8.0	4.0
687 626 xxx 002	26	xxx = 152 Length 152mm							
687 628 xxx 002	28								
687 630 xxx 002	30	xxx = 200 Length 200mm							
687 632 xxx 002	32								
687 633 xxx 002	33								
687 634 xxx 002	34								
687 635 xxx 002	35								
687 640 xxx 002	40								
687 644 xxx 002	44								
687 645 xxx 002	45								
687 650 xxx 002	50								



EXTENDED RANGE

0.50mm Flat Flexible Cable Type 2 WR-FPC

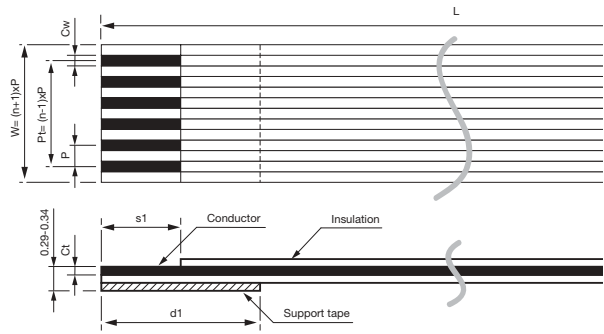
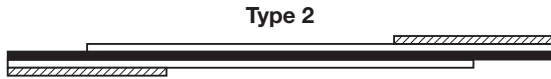

03



MATERIAL

- Insulation: PET (White)
- Support tape: PET (Blue)
- Flamability rating: UL Sub.758
- Contact material: Copper
- Contact plating: Tin
- Quality class: 20 Mating cycles minimum
- Pitch: 0.50 mm

- Tensile strength of insulation: More than 3.5kg/mm²
- Flexig test: 180° More than 20 times
- Abrasion: More than 10.000times
- Pull/Out: More than 20 times

ENVIRONMENTAL

- Operating temperature: -30 °C up to 105 °C
- Heat resistance: 85°C x 95Hrs
- Moisture resistance: 40°C, 95% RH x 96Hrs
- Compliance: Lead free and RoHS

ELECTRICAL

- Working voltage: 60V
- Current rating: 0.5 A
- Insulation resistance: 500 Vdc more than 1.000 MOhm
- Dielectric strength: 500 Vac/1mm No breakdown
- Conductor resistance: Less than 2.20Ohm/m
- Contact resistance: 20 mOhm max

MECHANICAL

- Elongation of insulator: More than 60 %

PACKAGING

Bag

Order Code	Pins	Length (mm)	Ct (mm)	Cw (mm)	W (mm)	Pt (mm)	P (mm)	d1 (mm)	s1 (mm)
687 706 xxx 002	6								
687 708 xxx 002	8								
687 710 xxx 002	10								
687 712 xxx 002	12								
687 714 xxx 002	14								
687 716 xxx 002	16								
687 717 xxx 002	17								
687 718 xxx 002	18								
687 720 xxx 002	20	xxx = 050 Length 50mm							
687 722 xxx 002	22								
687 724 xxx 002	24	xxx = 100 Length 100mm							
687 725 xxx 002	25		0.035	0.3	(n+1) x 0.5	(n-1) x 0.5	0.5	8.0	4.0
687 726 xxx 002	26	xxx = 152 Length 152mm							
687 728 xxx 002	28								
687 730 xxx 002	30	xxx = 200 Length 200mm							
687 732 xxx 002	32								
687 733 xxx 002	33								
687 734 xxx 002	34								
687 735 xxx 002	35								
687 740 xxx 002	40								
687 744 xxx 002	44								
687 745 xxx 002	45								
687 750 xxx 002	50								



Specific Flat Flexible Cable WR-FPC

Flat flexible cables offer an excellent flexibility able to support most of designer's wishes. That's why Würth Elektronik offers flexibility in design and let designer select pin n°, pitch, length, type. Special assembly requirements are also possible. Caution: specific FFC are subject to MOQ and will be studied by our product managers to check feasibility so we ask you to carefully fill in the following selection guide

03

Selection Guide								
Dimensions in mm								
N° of wires	Termination type 1 / 2 (See draw below)	Plating (Tin= Standard)	Pitch	Length	Support tape length		Strip length	
			P	L	d1+/-1.0	d2+/-1.0	s1+/-2.0	s2+/-2.0
			0.5 / 1.0mm	Overall length	0.5mm pitch: d1 = d2 = 8.0mm 1.0mm pitch: d1 = d2 = 10.0mm		0.5mm pitch: s1 = s2 = 4.0mm 1.0mm pitch: s1 = s2 = 5.0mm	
		Tin						

Please fill in the red area according to your needs

Formed, shielded, terminated, special packaging or any other specific request please submit drawing for quotation

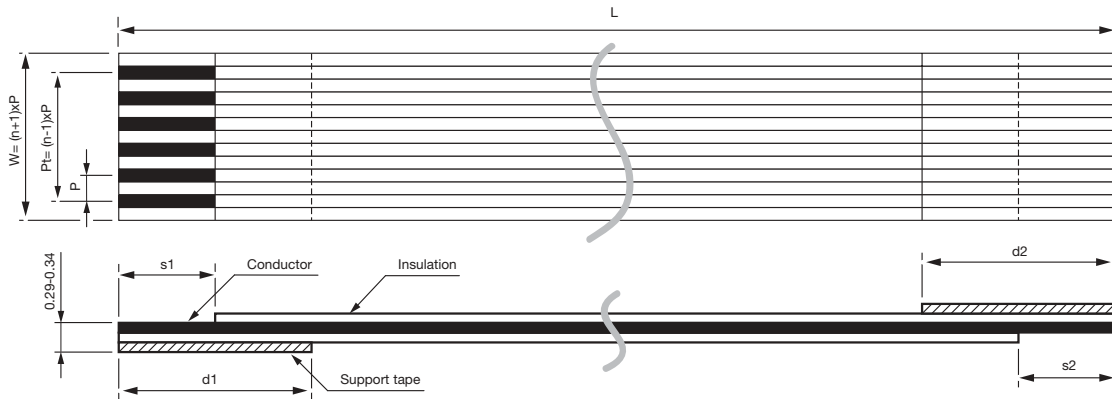

Termination Type



NEW

Design Kit WR-FPC



03



Order Code 687 001

Design Kit WR-FPC

All the parts of the assortment are detailed below

P/N in the Kit	Pins	Description
686 114 144 22	4 to 30	1.00mm SMT ZIF Horizontal Bottom Contact
686 114 141 22	4 to 30	1.00mm SMT ZIF Horizontal TOP Contact
686 1 124 422	4 to 28	1.00mm SMT ZIF Vertical Type A
687 1xx 145 22	4 to 50	0.5mm SMT ZIF Horizontal Bottom Contact
687 1xx 140 22	4 to 50	0.5mm SMT ZIF Horizontal TOP Contact
687 1xx 124 422	4 to 50	0.5mm SMT ZIF Vertical Type A
687 1xx 124 322	4 to 50	0.5mm SMT ZIF Vertical Type B
686 6xx 050 001	10 & 20	1.00mm Flat Flexible Cable Type 1
686 7xx 050 001	10 & 20	1.00mm Flat Flexible Cable Type 2
687 6xx 050 002	10 & 20	0.5mm Flat Flexible Cable Type 1
687 7xx 050 002	10 & 20	0.5mm Flat Flexible Cable Type 2



Notes: