

4.2V to 18V, 2A 1ch Synchronous Buck Converter integrated FET

BD1482EFJ

●General Description

The BD1482EFJ is a synchronous step-down switching regulator that integrates 2 low ON-resistance N-channel MOSFETs. It achieves 2A continuous output current over a wide input supply range. Current mode operation provides fast transient response and easy phase compensation.

●Features

- Low ESR Output Ceramic Capacitors are Available
- Low Standby Current during Shutdown Mode
- 380 kHz Fixed Operating Frequency
- Feedback voltage
 - 0.923V ± 1.5%(Ta=25°C),
 - 0.923V ± 2.0%(Ta=-25°C to 85°C)
- Protection Circuits
 - Under Voltage Lockout Protection
 - Thermal Shutdown
 - Over Current Protection

●Applications

Distributed Power System
Pre-Regulator for Linear Regulator

●Typical Application Circuit

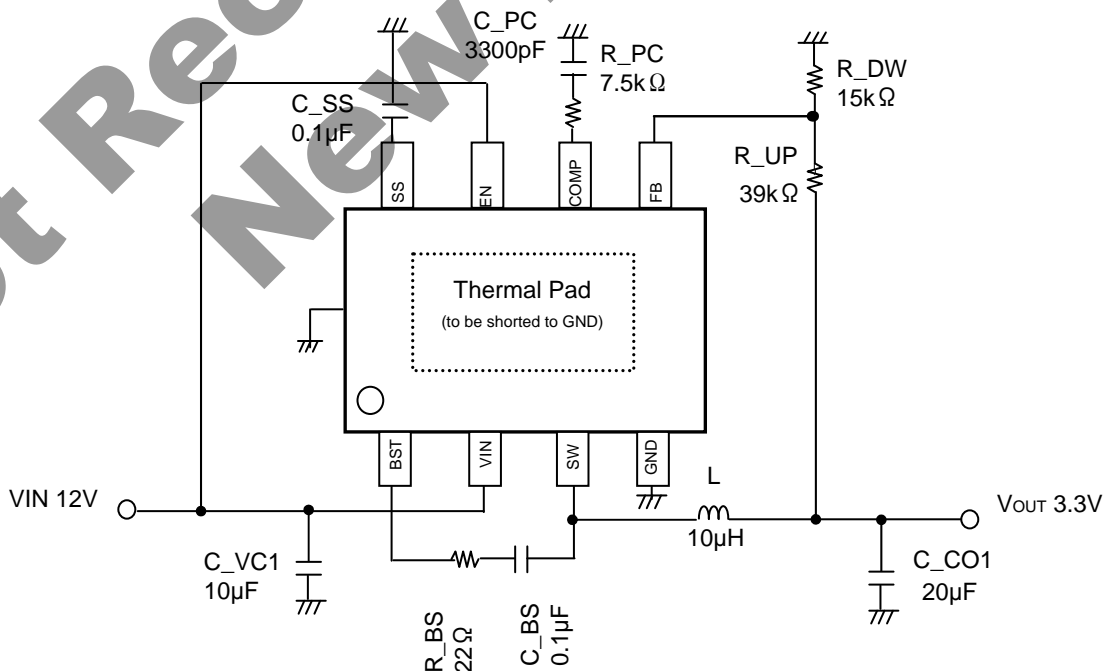

※R_BS protect from VIN-BST short destruction.

Fig.1 Typical Application Circuit

●Key Specifications

- Input voltage range: 4.2V to 18V
- Output voltage range: 0.923V to (Vin × 0.7)V
- Output current: 2.0A (Max.)
- Switching Frequency: 380kHz(Typ.)
- Hi-side FET On-resistance: 0.15Ω (Typ.)
- Lo-side FET On-resistance: 0.13Ω (Typ.)
- Standby current: 15µA (Typ.)
- Operating temperature range: -40°C to +85°C

●Package

HTSOP-J8 (Typ.) (Typ.) (Max.)
4.90mm x 6.00mm x 1.00mm

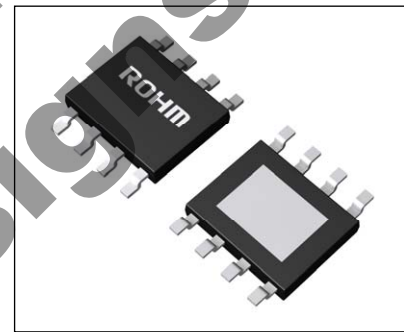

HTSOP-J8

●Pin Configuration

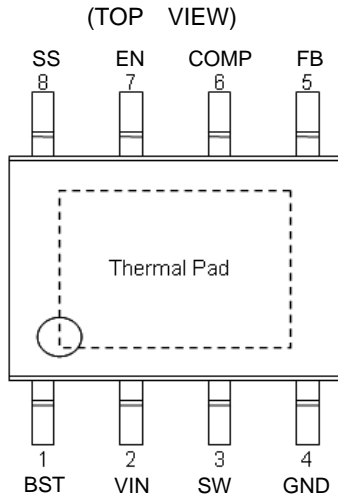

Fig.2 Pin Configuration

●Block Diagram

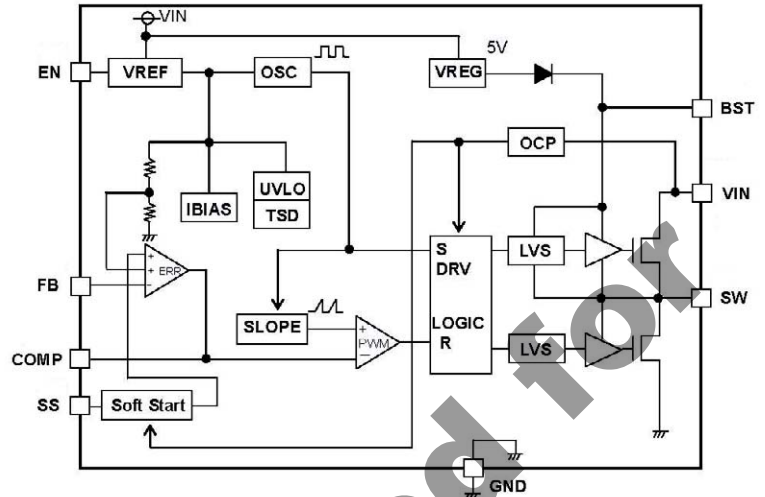

Fig.3 Block Diagram

●Pin Description

Pin No.	Pin name	Function
1	BST	High-Side Gate Drive Boost Input
2	VIN	Power Input
3	SW	Power Switching Output
4	GND	Ground
5	FB	Feed Back Input
6	COMP	Compensation Node
7	EN	Enable Input
8	SS	Soft Start Control Input

●Block Operation

- VREG
A block to generate constant-voltage for DC/DC boosting.
- VREF
A block that generates internal reference voltage of 5.1 V (Typ.).
- TSD/UVLO
TSD (Thermal shutdown)/UVLO (Under Voltage Lockout) protection block. The TSD circuit shuts down IC at high temperature. The UVLO circuit shuts down the IC when the VIN is Low Voltage.
- Error amp block (ERR)
This is the circuit to compare the reference voltage and the feedback voltage of output voltage. The COMP pin voltage resulting from this comparison determines the switching duty. At the time of startup, since the soft start is operated by the SS pin voltage, the COMP pin voltage is limited to the SS pin voltage.
- Oscillator block (OSC)
This block generates the oscillating frequency.
- SLOPE block
This block generates the triangular waveform from the clock created by OSC. Generated triangular waveform is sent to the PWM comparator.
- PWM block
The COMP pin voltage output by the error amp is compared to the SLOPE block's triangular waveform to determine the switching duty. Since the switching duty is limited by the maximum duty ratio which is determined internally, it does not become 100%.
- DRV block
A DC/DC driver block. A signal from the PWM is input to drive the power FETs.
- OCP block
OCP (Over Current Protection) block. The current which flowed into FET is detected and OCP starts at 3.5A (min). After OCP, switching is turned off and SS capacitor is discharged. OCP is not latch type but auto restart.
- Soft start circuit
Since the output voltage rises gradually while restricting the current at the time of startup, it is possible to prevent the output voltage overshoot or the rush current.

● Absolute Maximum Ratings($T_a = 25^\circ\text{C}$)

Parameter	Symbol	Ratings	Unit
Supply Voltage	V _{IN}	20	V
Switch Voltage	V _{SW}	20	V
Power Dissipation for HTSOP-J8	P _d	3760 ^{*1}	mW
Package thermal resistance θ_{ja} ^{*2}	θ_{ja}	29.27	$^\circ\text{C}/\text{W}$
Package thermal resistance θ_{jc} ^{*2}	θ_{jc}	3.75	$^\circ\text{C}/\text{W}$
Operating Temperature Range	T _{opr}	-40 to +85	$^\circ\text{C}$
Storage Temperature Range	T _{stg}	-55 to +150	$^\circ\text{C}$
Maximum Junction Temperature	T _{jmax}	150	$^\circ\text{C}$
BST Voltage	V _{BST}	V _{SW} +7	V
EN Voltage	V _{EN}	20	V
All other pins	V _{OTH}	20	V

*1 Derating is done 30.08 mW/ $^\circ\text{C}$ for operating above $T_a \geq 25^\circ\text{C}$ (Mount on 4-layer 70.0mm x 70.0mm x 1.6mm board)

*2 Mount on 4-layer 50mm x 30mm x 1.6mm application board

● Operating Ratings ($T_a = -40$ to 85°C)

Parameter	Symbol	Ratings			Unit
		Min	Typ	Max	
Supply Voltage	V _{IN}	4.2	12	18	V
SW Voltage	V _{SW}	-0.5	-	18	V
Output current	I _{SW3}	-	-	2	A
Output voltage range	V _{RANGE}	0.923	-	V _{IN} x 0.7	V

● Electrical Characteristics (Unless otherwise specified V_{IN}=12V $T_a=25^\circ\text{C}$)

Parameter	Symbol	Limits			Unit	Conditions
		Min	Typ	Max		
Error amplifier block						
FB input bias current	I _{FB}	-	0.02	2	μA	
Feedback voltage1	V _{FB1}	0.910	0.923	0.938	V	Voltage follower
Feedback voltage2	V _{FB2}	0.906	0.923	0.942	V	$T_a = -25^\circ\text{C}$ to 85°C
SW block						
High-side FET On-resistance	R _{ONH}	-	0.15	-	Ω	I _{SW} = -0.8A
Low-side FET On-resistance	R _{ONL}	-	0.13	-	Ω	I _{SW} = 0.8A
High/Low-side FET Leak current	I _{LEAKN}	-	0	10	μA	V _{IN} = 18V, V _{SW} = 0V / 18V
Switch Current Limit	I _{LIMIT3}	3.5	-	-	A	
Maximum duty cycle	M _{DUTY}	-	90	-	%	V _{FB} = 0V
General						
Enable Sink current	I _{EN}	45	90	135	μA	V _{EN} = 12V
Enable Threshold voltage	V _{EN}	0.6	1.2	1.4	V	
Under Voltage Lockout threshold	V _{UVLO}	3.5	3.75	4.0	V	V _{IN} rising
Under Voltage Lockout Hysteresis	V _{HYS}	-	0.3	-	V	
Soft Start Current	I _{SS}	5	10	15	μA	V _{SS} = 0 V
Soft Start Time	T _{SS}	-	22	-	ms	C _{SS} = 0.1 μF
Operating Frequency	F _{OSC}	300	380	460	kHz	
Circuit Current	I _{CC}	-	1.2	3	mA	V _{FB} = 1.5V, V _{EN} = 12V
Standby Current	I _{QUI}	-	15	27	μA	V _{EN} = 0V

● Typical Performance Curves

(Unless otherwise specified, VIN= 12V Ta = 25°C)

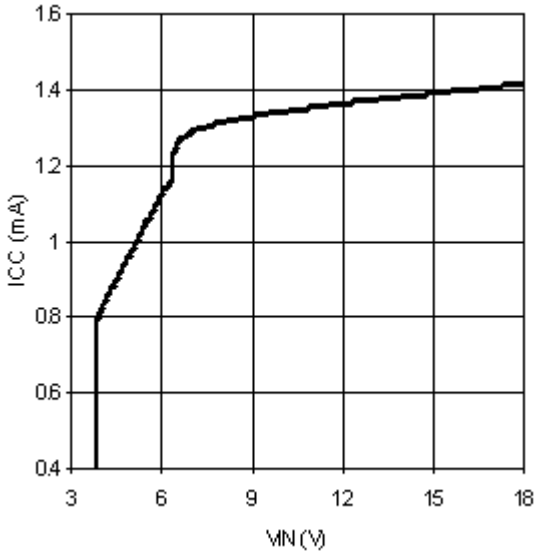

Fig.4 Circuit Current
(No switching)

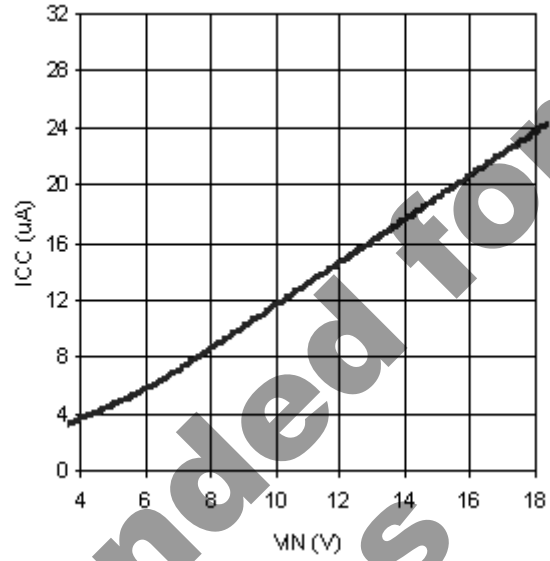

Fig.5 Stand by current
(IC not active)

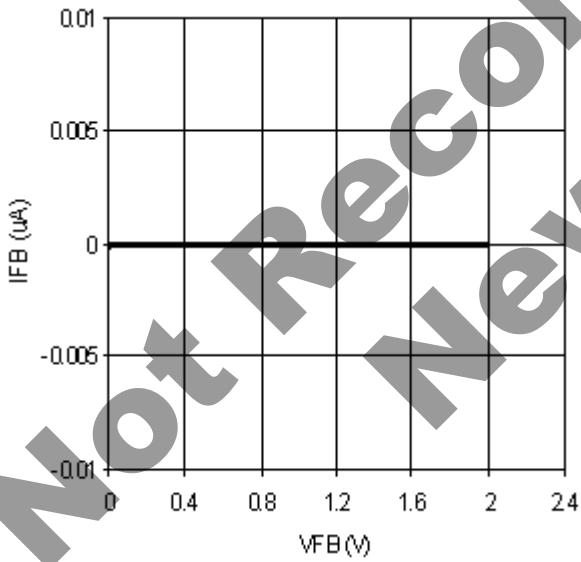

Fig.6 Input Bias Current

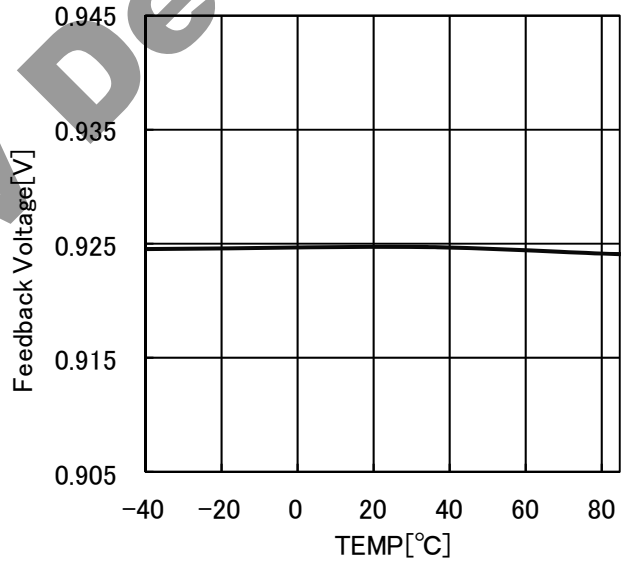

Fig.7 Feedback voltage

●Typical Performance Curves

(Unless otherwise specified, VIN= 12V Ta = 25°C) (Continued)

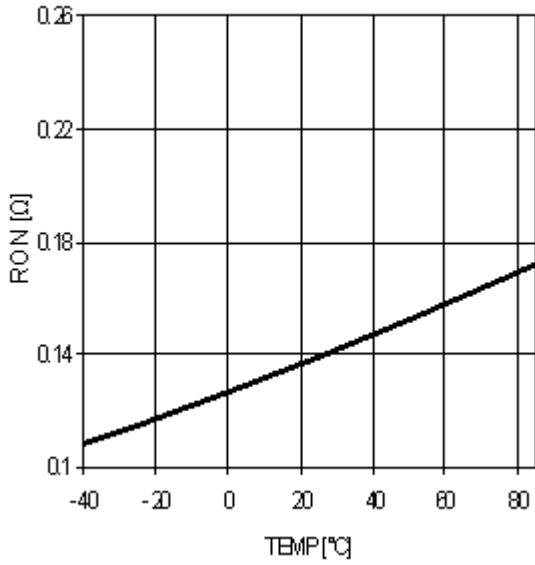

Fig.8 Hi,Low-Side On-resistance

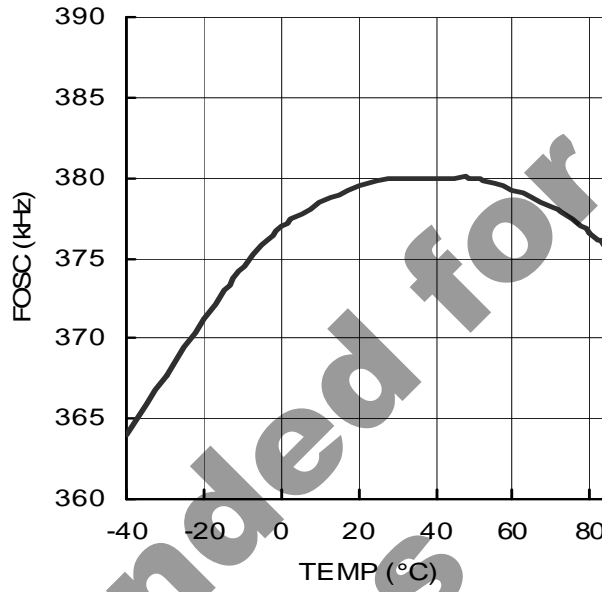

Fig.9 Operating Frequency

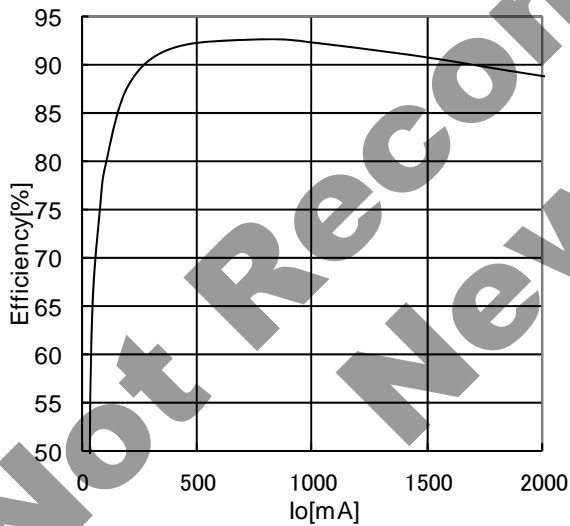

Fig.10 STEP Down Efficiency
(VIN= 12V VOUT= 3.3V L=10μH)

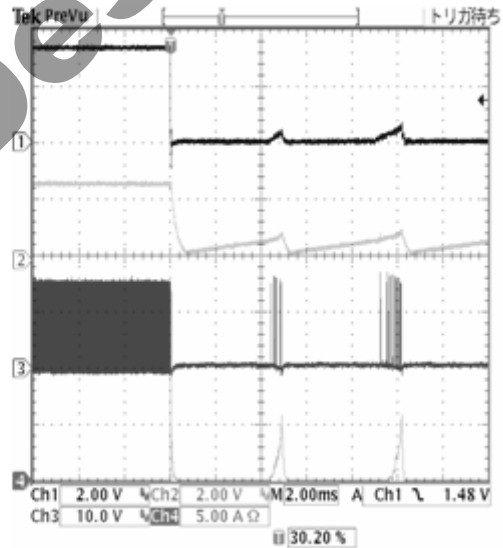

Fig.11 OverCurrent Protection
(Vout is shorted to GND)

● Typical Performance Curves

(Unless otherwise specified, VIN= 12V Ta = 25°C) (Continued)

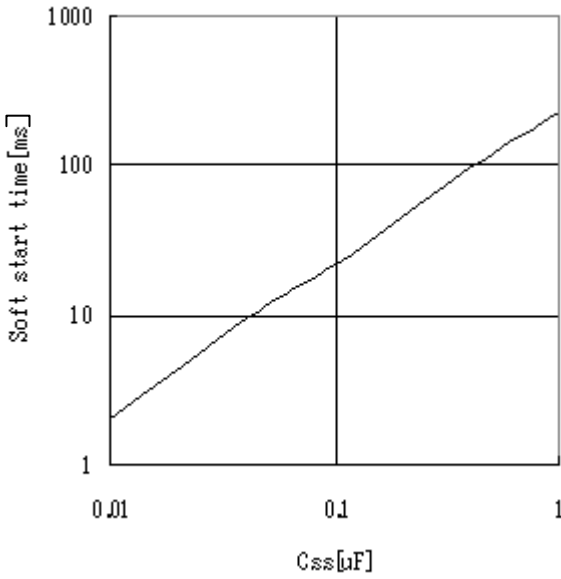

Fig.12 Soft Start Time

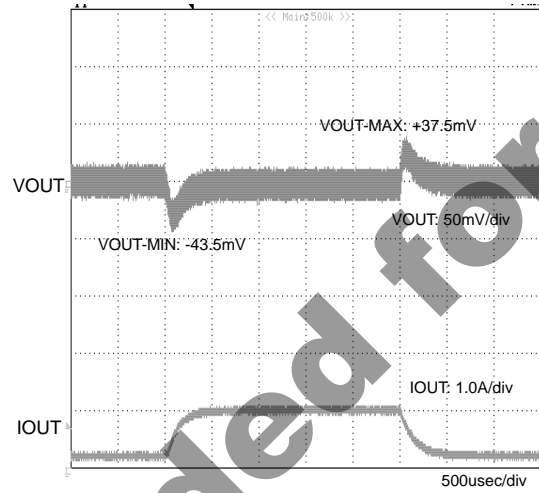

Fig.13 Transient Response
(VIN= 12V VOUT= 3.3V L= 10µH Cout =22µF Iout= 0.2-1.0A)

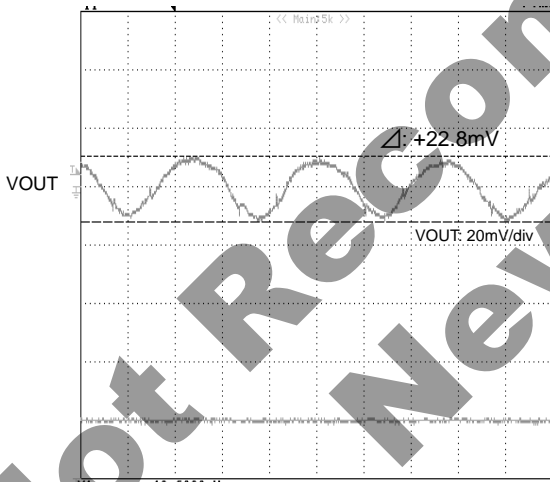

Fig.14 Output Ripple Voltage
(VIN= 12V VOUT= 3.3V L= 10µH Cout =22µF Iout= 1.0A)

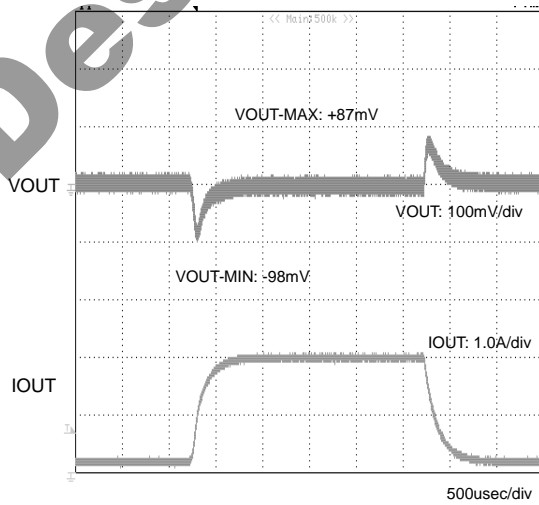

Fig.15 Transient Response
(VIN= 12V VOUT= 3.3V L= 10µH Cout =22µF Iout= 0.2-2.0A)

●Typical Performance Curves

(Unless otherwise specified, VIN= 12V Ta = 25°C) (Continued)

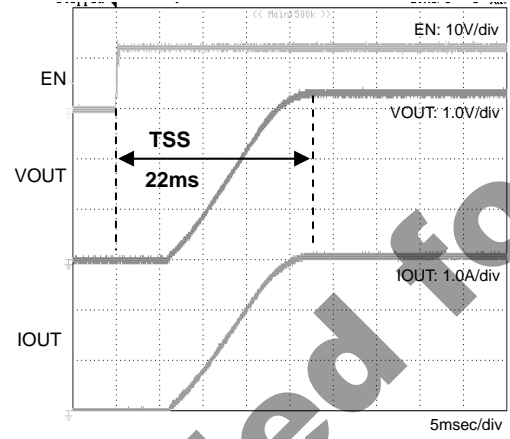
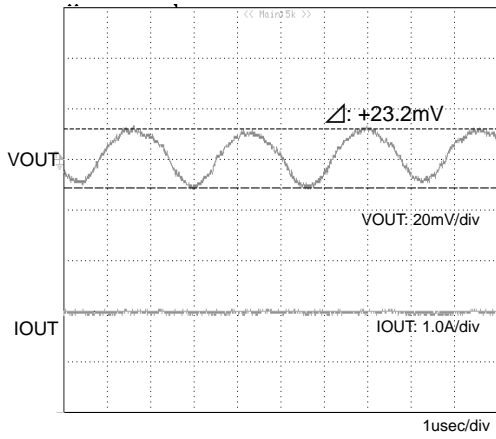

Fig.16 Output Ripple Voltage
(VIN= 12V VOUT= 3.3V L= 10μH Cout =22μF Iout= 2.0A)

Fig.17 Start Up waveform
(VIN= 12V VOUT= 3.3V L= 10μH CSS= 0.1μF)

Not Recommended for New Designs

●Application Information
Typical Application Circuit

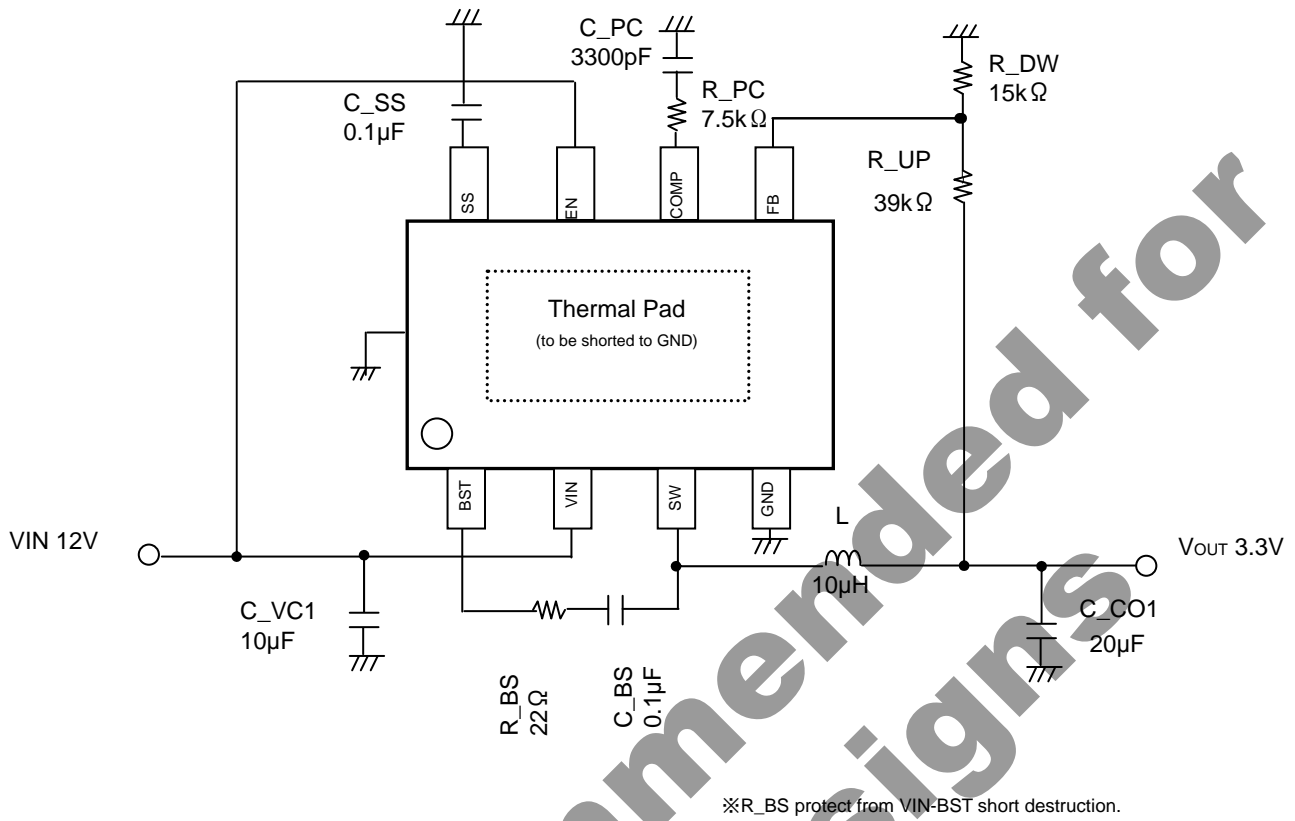

Fig.18 Application Circuit

	Symbol	Maker	Part No	
Input capacitor	C_VC1	TDK	C3225JB1E106K	10µF/25V
Output capacitor	C_CO1	TDK	C3216JB1C106M	10µF/16V
Inductor	L	TDK	SLF10165-100M3R8	10µH/3.8A

Selecting Application Components

(1) Output LC filter constant selection (Buck Converter)

The Output LC filter is required to supply constant current to the output load. A larger value inductance at this filter results in less inductor ripple current (ΔI_L) and less output ripple voltage. However, the larger value inductors tend to have less fast load transient-response, a larger physical size, a lower saturation current and higher series resistance. A smaller value inductance has almost opposite characteristics above. So Choosing the Inductor ripple current (ΔI_L) between 20 to 40% of the averaged inductor current (equivalent to the output load current) is a good compromise.

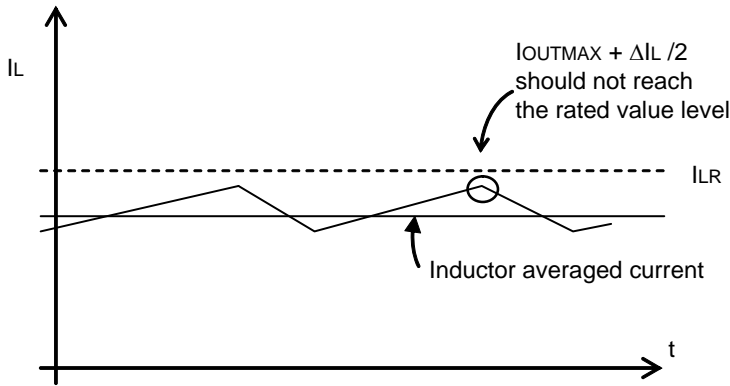

Fig.19

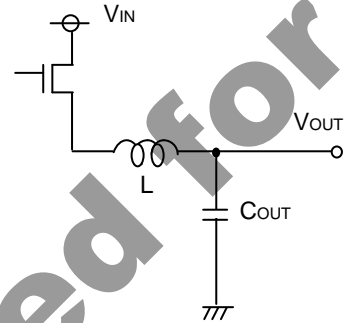

Fig.20

Setting $\Delta I_L = 30\% \times \text{Averaged Inductor current (2A)} = 0.6 \text{ [A]}$

$$L = \frac{V_{OUT} \times (V_{IN} - V_{OUT}) \times 1}{V_{IN} \times F_{OSC} \times \Delta I_L} = 10\mu \text{ [H]}$$

Where $V_{IN} = 12V$, $V_{OUT} = 3.3V$, $F_{OSC} = 380 \text{ kHz}$,
; F_{OSC} is a switching frequency

Also the inductor should have the higher saturation current than $I_{OUTMAX} + \Delta I_L / 2$.

The output capacitor C_{OUT} affects the output ripple-voltage. Choose the large capacitor to achieve the small ripple-voltage enough to meet the application requirement.

Output ripple voltage ΔV_{RPL} is calculated by the following equation.

$$\Delta V_{RPL} = \Delta I_L \times \left(R_{ESR} + \frac{1}{8 \times C_{OUT} \times F_{OSC}} \right) \text{ [V]}$$

Where R_{ESR} is a parasitic series resistance in output capacitor.

Setting $C_{OUT} = 20\mu F$, $R_{ESR} = 10m\Omega$

$$\Delta V_{RPL} = 0.6 \times \left(10m + \frac{1}{8 \times 20\mu \times 380k} \right) = 15.8mV$$

(2) Loop Compensation

Choosing compensation capacitor C_{CMP} and resistor R_{CMP}

The current-mode buck converter has 2-poles and 1-zero system. Choosing the compensation resistor and capacitor is important for a good load-transient response and good stability.

The example of DC/DC converter application bode plot is shown below.

The compensation resistor R_{CMP} will decides the cross over frequency F_{CRS} (the frequency that the total DC-DC loop-gain falls to 0dB).

Setting the higher cross over frequency achieves good response speed, however less stability. While setting the lower cross over frequency shows good stability but worse response speed.

The 1/10 of switching frequency for the cross over frequency shows a good performance at most applications.

- (i) Choosing phase compensation resistor R_{CMP}
The compensation resistor R_{CMP} can be on following formula.

$$R_{CMP} = \frac{2\pi \times V_{OUT} \times F_{CRS} \times C_{OUT}}{V_{FB} \times G_{MP} \times G_{MA}} \quad [\Omega]$$

Where

V_{OUT} ; Output voltage, F_{CRS} ; Cross over frequency, C_{OUT} ; Output Capacitor,
 V_{FB} ; internal feedback voltage (0.923V(TYP)), G_{MP} ; Current Sense Gain (7.8A/V(TYP)) ,
 G_{MA} ; Error Amplifier Trans-conductance (300μA/V(TYP))

Setting $V_{OUT}= 3.3V$, $F_{CRS}= 38kHz$, $C_{OUT}= 20\mu F$;

$$R_{CMP} = \frac{2\pi \times 3.3 \times 38k \times 20u}{0.923 \times 7.8 \times 300u} = 7.30k \approx 7.5k \quad [\Omega]$$

- (ii) Choosing phase compensation capacitor C_{CMP}

For the stability of DC/DC converter, canceling the phase delay that derives from output capacitor C_{OUT} and resistive load R_{OUT} by inserting the phase advance.

The phase advance can be added by the zero on compensation resistor R_{CMP} and capacitor C_{CMP} .

Making $F_z = F_{CRS} / 6$ gives a first-order estimate of C_{CMP} .

Compensation Capacitor $C_{CMP} = \frac{1}{2\pi \times R_{CMP} \times F_z} \quad [F]$

Setting $F_z = F_{CRS}/6 = 6.3kHz$;

Compensation Capacitor $C_{CMP} = \frac{1}{2\pi \times 7.5k \times 6.3k} = 3.54n \approx 3.3n \quad [F]$

However, the best values of zero and F_{CRS} are different between applications. After calculation above formula and confirmation actual application, please decide values finally.

- (iii) The condition of the loop compensation stability

The stability of DC/DC converter is important. To secure the operating stability, please check the loop compensation has the enough phase-margin. For the condition of loop compensation stability, the phase-delay must be less than 150 degree where Gain is 0 dB.

Feed forward capacitor C_{RUP} boosts phase margin over a limited frequency range and is sometimes used to improve loop response. C_{RUP} will be more effective if $R_{UP} \gg R_{UP} || R_{DW}$

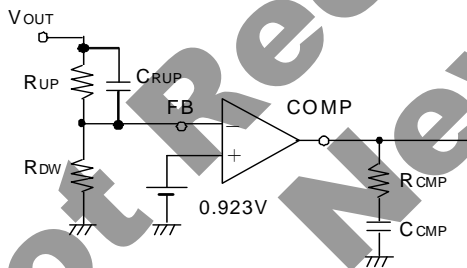

Fig.21

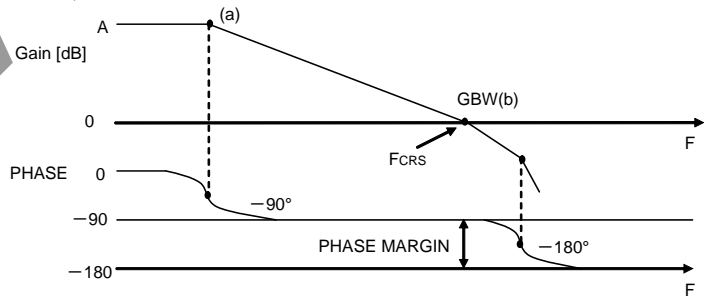

Fig.22

- (3) Design of Feedback Resistance constant
Set the feedback resistance as shown below.

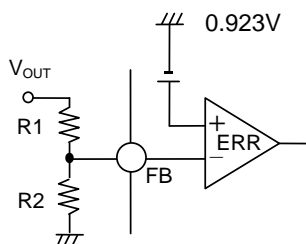

Fig.23

$$V_{OUT} = \frac{R1 + R2}{R2} \times 0.923 \quad [V]$$

Soft Start Function

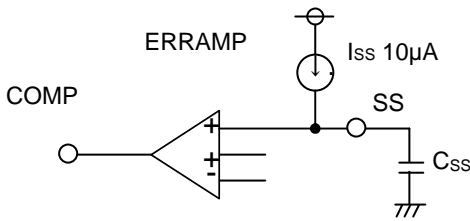

Fig.24

An adjustable soft-start function to prevent high inrush current during start-up is available. The soft-start time is set by the external capacitor connected to SS pin.

The soft start time is given by;

$$T_{ss} [s] = 2.2 \times C_{ss} / I_{ss}$$

Setting $C_{ss} = 0.1\mu F$;

$$T_{ss} = 2.2 \times 0.1\mu / 10\mu = 22 [ms]$$

Please confirm the overshoot of the output voltage and inrush current when deciding the SS capacitor value.

EN Function

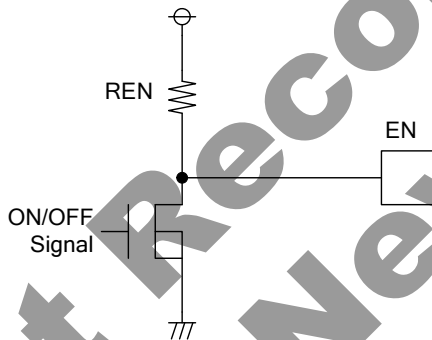
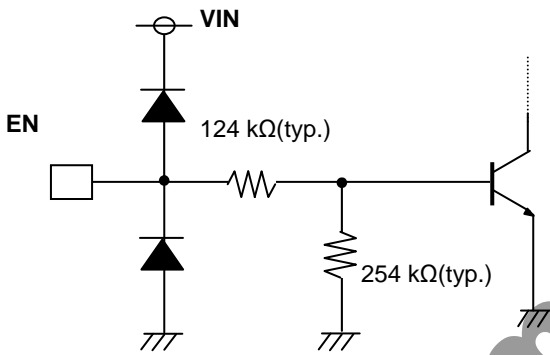

Fig.25

The EN terminal control IC's shut down. Leaving EN terminal open makes IC shutdown. To start the IC, EN terminal should be connected to VIN or the other power source output. When the EN voltage exceed 1.2V (typ.), the IC start operating. The IC also has the hysteresis voltage 0.2V (typ.) of EN when EN voltage falls down.

(Attention1)

Chattering happens if standing lowering speed is slow when standing of EN pin is lowered.

The reverse current in which the input side and the pressure operation are done from the output side is generated when chattering operates with the output voltage remained, and there is a case to destruction.

Please set to stand within 100us when you control ON/OFF by the EN signal.

This necessity doesn't exist when EN pin is connected with VIN and EN is not controlled.

The control by open drain MOSFET shown in a left chart is recommended.

(Attention 2)

In case the output voltage is used in a setting of more than 5V, when EN signal is turned off, please start up EN again after output voltage is discharged enough.

If EN is turned on although output voltage isn't discharged enough, BST circuit doesn't operate normally.

As the result, the IC is not operated, in the worst case, it is destroyed.

Layout Pattern Consideration

Two high pulsing current flowing loops exist in the buck regulator system. The first loop, when FET is ON, starts from the input capacitors, to the VIN terminal, to the SW terminal, to the inductor, to the output capacitors, and then returns to the input capacitor through GND. The second loop, when FET is OFF, starts from the low FET, to the inductor, to the output capacitor, and then returns to the low FET through GND. To reduce the noise and improve the efficiency, please minimize these two loop area. Especially input capacitor, output capacitor and low FET should be connected to GND plain. PCB Layout may affect the thermal performance, noise and efficiency greatly. So please take extra care when designing PCB Layout patterns.

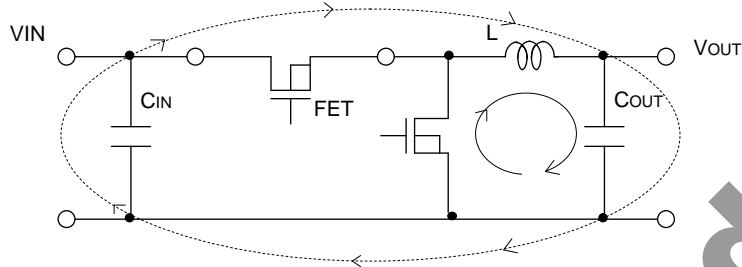

Fig.26 Current loop in Buck regulator system

- The thermal Pad on the back side of IC has the great thermal conduction to the chip. So using the GND plain as broad and wide as possible can help thermal dissipation. And a lot of thermal via for helping the spread of heat to the different layer is also effective.
- The input capacitors should be connected as close as possible to the VIN terminal.
- When there is unused area on PCB, please arrange the copper foil plain of DC nodes, such as GND, VIN and VOUT for helping heat dissipation of IC or circumference parts.
- To avoid the noise influence from AC combination with the other line, keep the switching line such as SW not extend as much as possible, and trace shortly and thickly to coil.
- Keep sensitive signal traces such as trace connected FB and COMP away from SW pin.
- The inductor and the output capacitors should be placed close to SW pin as much as possible.

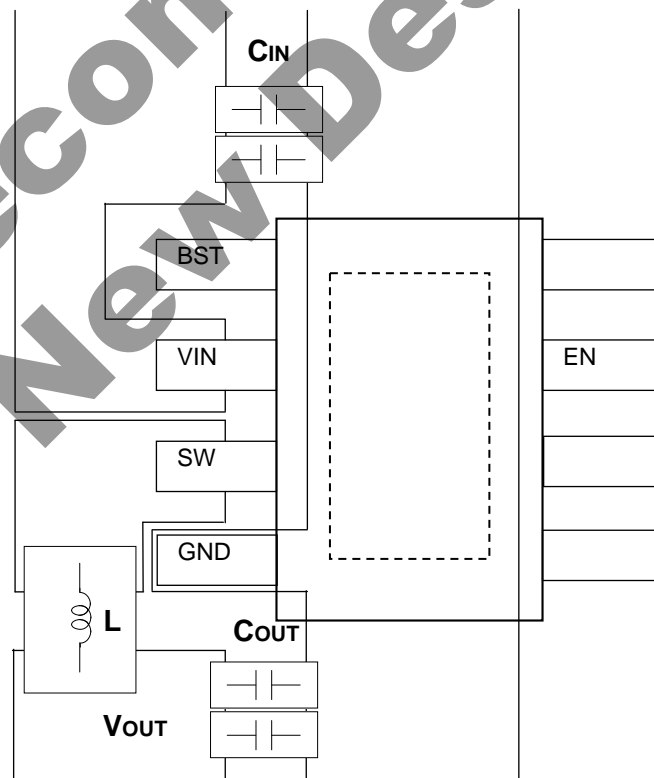

Fig.27 The example of PCB layout pattern

● I/O Equivalent Circuit Diagram

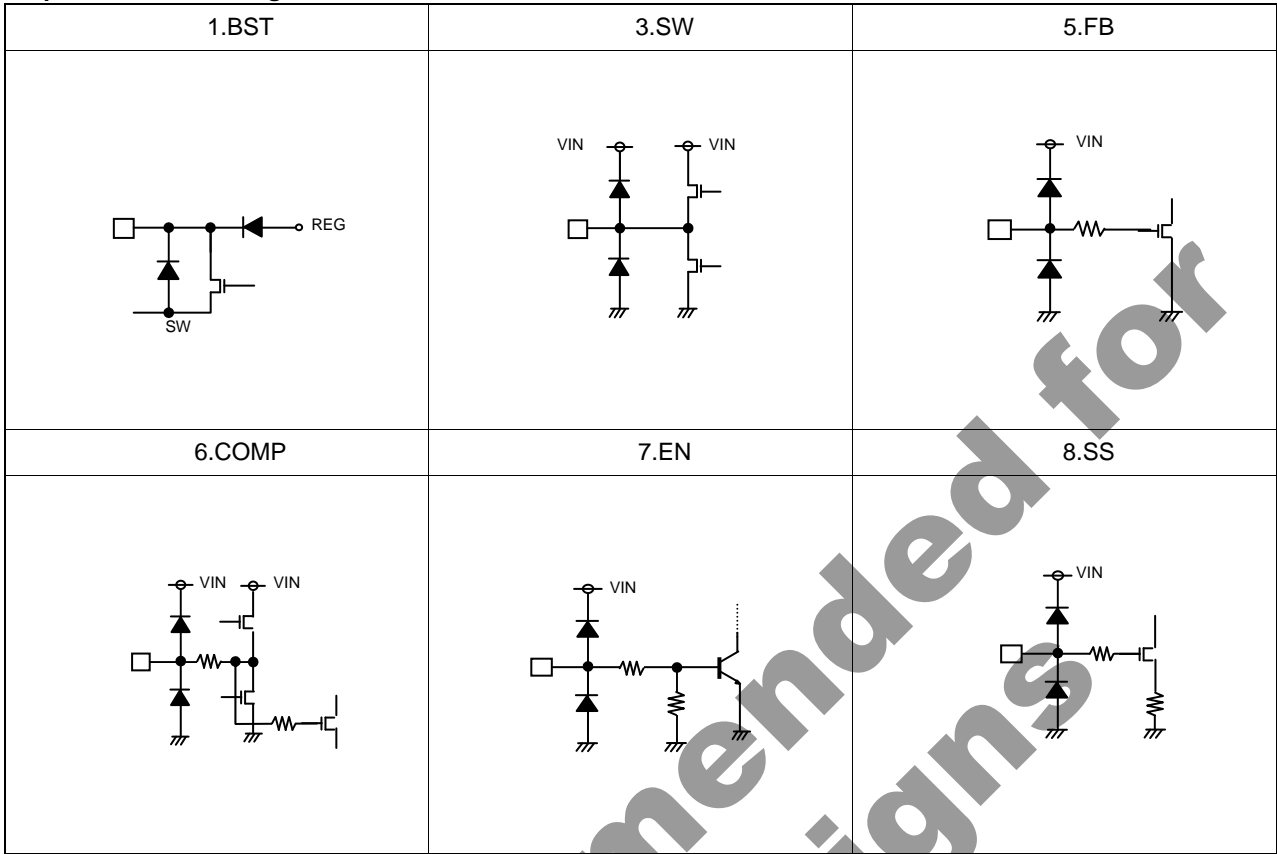
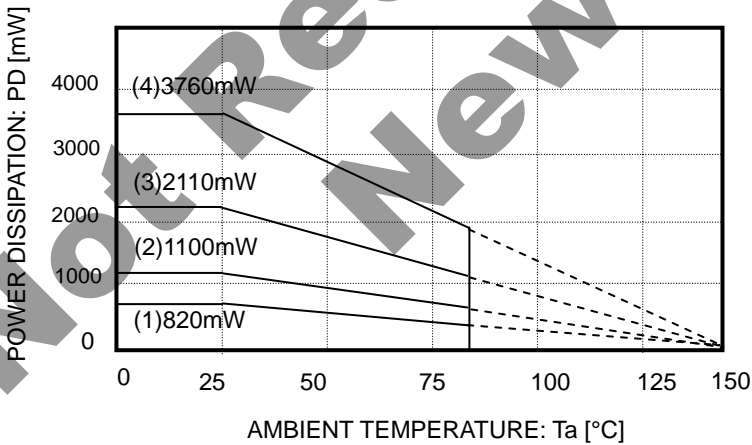

Fig.28 I/O Equivalent Circuit

● Power Dissipation



HTSOP-J8 Package

On 70 × 70 × 1.6 mm glass epoxy PCB

- (1) 1-layer board (Backside copper foil area 0 mm × 0 mm)
- (2) 2-layer board (Backside copper foil area 15 mm × 15 mm)
- (3) 2-layer board (Backside copper foil area 70 mm × 70 mm)
- (4) 4-layer board (Backside copper foil area 70 mm × 70 mm)

●Operational Notes

- 1) Absolute maximum ratings
Use of the IC in excess of absolute maximum ratings such as the applied voltage or operating temperature range may result in IC damage. Assumptions should not be made regarding the state of the IC (short mode or open mode) when such damage is suffered. A physical safety measure such as a fuse should be implemented when use of the IC in a special mode where the absolute maximum ratings may be exceeded is anticipated.
- 2) GND potential
Ensure a minimum GND pin potential in all operating conditions.
- 3) Setting of heat
Use a thermal design that allows for a sufficient margin in light of the power dissipation (Pd) in actual operating conditions.
- 4) Pin short and mistake fitting
Use caution when orienting and positioning the IC for mounting on printed circuit boards. Improper mounting may result in damage to the IC. Shorts between output pins or between output pins and the power supply and GND pins caused by the presence of a foreign object may result in damage to the IC.
- 5) Actions in strong magnetic field
Use caution when using the IC in the presence of a strong magnetic field as doing so may cause the IC to malfunction.
- 6) Testing on application boards
When testing the IC on an application board, connecting a capacitor to a pin with low impedance subjects the IC to stress. Always discharge capacitors after each process or step. Ground the IC during assembly steps as an antistatic measure, and use similar caution when transporting or storing the IC. Always turn the IC's power supply off before connecting it to or removing it from a jig or fixture during the inspection process.
- 7) Ground wiring patterns
When using both small signal and large current GND patterns, it is recommended to isolate the two ground patterns, placing a single ground point at the application's reference point so that the pattern wiring resistance and voltage variations caused by large currents do not cause variations in the small signal ground voltage. Be careful not to change the GND wiring patterns of any external components.
- 8) Regarding input pin of the IC
This monolithic IC contains P+ isolation and P substrate layers between adjacent elements in order to keep them isolated. P/N junctions are formed at the intersection of these P layers with the N layers of other elements to create a variety of parasitic elements.
For example, when the resistors and transistors are connected to the pins as shown in Fig.29, a parasitic diode or a transistor operates by inverting the pin voltage and GND voltage.
The formation of parasitic elements as a result of the relationships of the potentials of different pins is an inevitable result of the IC's architecture. The operation of parasitic elements can cause interference with circuit operation as well as IC malfunction and damage. For these reasons, it is necessary to use caution so that the IC is not used in a way that will trigger the operation of parasitic elements such as by the application of voltages lower than the GND (P substrate) voltage to input and output pins.

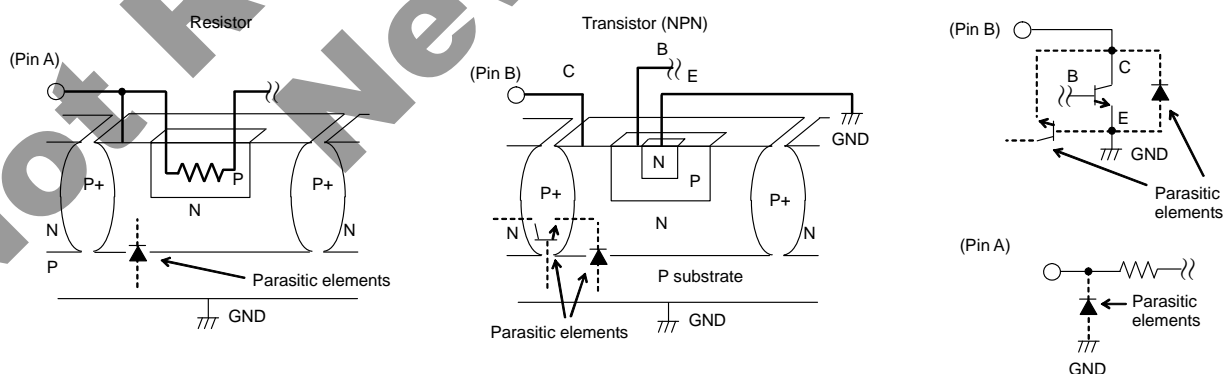

Fig.29 Example of a Simple Monolithic IC Architecture

- 9) Overcurrent protection circuits
An overcurrent protection circuit designed according to the output current is incorporated for the prevention of IC damage that may result in the event of load shorting. This protection circuit is effective in preventing damage due to sudden and unexpected accidents. However, the IC should not be used in applications characterized by the continuous operation or transitioning of the protection circuits. At the time of thermal designing, keep in mind that the current capacity has negative characteristics to temperatures.

10) Thermal shutdown circuit (TSD)

This IC incorporates a built-in TSD circuit for the protection from thermal destruction. The IC should be used within the specified power dissipation range. However, in the event that the IC continues to be operated in excess of its power dissipation limits, the attendant rise in the chip's junction temperature T_j will trigger the TSD circuit to turn off all output power elements. Operation of the TSD circuit presumes that the IC's absolute maximum ratings have been exceeded. Application designs should never make use of the TSD circuit.

11) EN control speed

Chattering happens if standing lowering speed is slow when standing of EN pin is lowered. The reverse current in which the input side and the pressure operation are done from the output side is generated when chattering operates with the output voltage remained, and there is a case to destruction. Please set to stand within 100 μ s when you control ON/OFF by the EN signal.

Not Recommended for
New Designs

Status of this document

The Japanese version of this document is formal specification. A customer may use this translation version only for a reference to help reading the formal version.

If there are any differences in translation version of this document formal version takes priority.

● Ordering Information

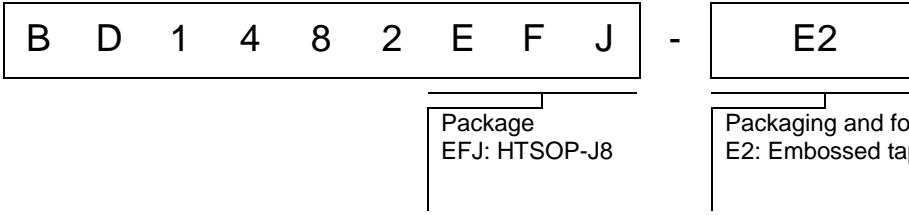

● Physical Dimension Tape and Reel Information

HTSOP-J8

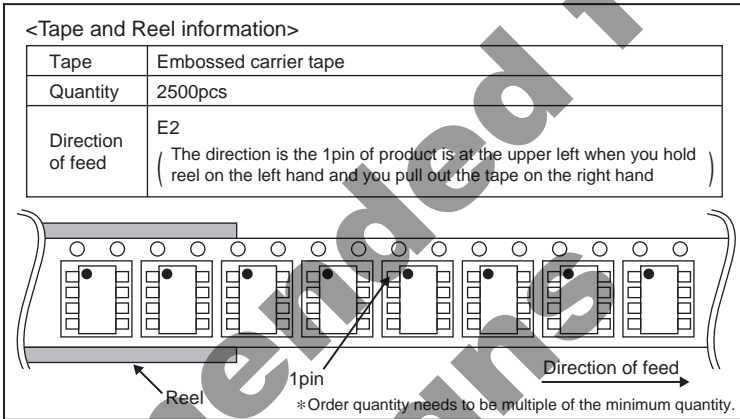
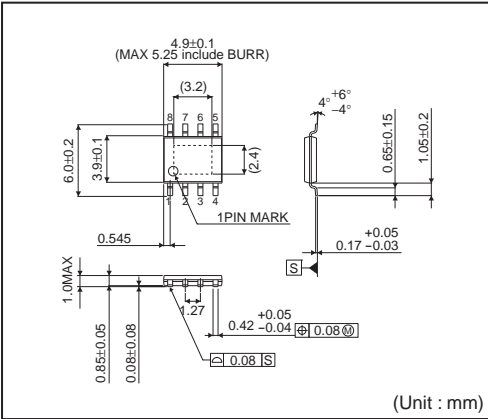

● Marking Diagram

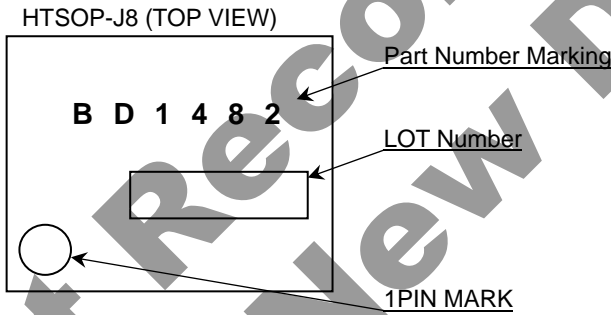

●Revision History

Date	Revision	Changes
06.Aug.2012	001	New Release

**Not Recommended for
New Designs**

Notice

Precaution on using ROHM Products

- Our Products are designed and manufactured for application in ordinary electronic equipments (such as AV equipment, OA equipment, telecommunication equipment, home electronic appliances, amusement equipment, etc.). If you intend to use our Products in devices requiring extremely high reliability (such as medical equipment ^(Note 1), transport equipment, traffic equipment, aircraft/spacecraft, nuclear power controllers, fuel controllers, car equipment including car accessories, safety devices, etc.) and whose malfunction or failure may cause loss of human life, bodily injury or serious damage to property ("Specific Applications"), please consult with the ROHM sales representative in advance. Unless otherwise agreed in writing by ROHM in advance, ROHM shall not be in any way responsible or liable for any damages, expenses or losses incurred by you or third parties arising from the use of any ROHM's Products for Specific Applications.

(Note1) Medical Equipment Classification of the Specific Applications

JAPAN	USA	EU	CHINA
CLASS III	CLASS III	CLASS II b	CLASS III
CLASS IV		CLASS III	

- ROHM designs and manufactures its Products subject to strict quality control system. However, semiconductor products can fail or malfunction at a certain rate. Please be sure to implement, at your own responsibilities, adequate safety measures including but not limited to fail-safe design against the physical injury, damage to any property, which a failure or malfunction of our Products may cause. The following are examples of safety measures:
 - Installation of protection circuits or other protective devices to improve system safety
 - Installation of redundant circuits to reduce the impact of single or multiple circuit failure
- Our Products are designed and manufactured for use under standard conditions and not under any special or extraordinary environments or conditions, as exemplified below. Accordingly, ROHM shall not be in any way responsible or liable for any damages, expenses or losses arising from the use of any ROHM's Products under any special or extraordinary environments or conditions. If you intend to use our Products under any special or extraordinary environments or conditions (as exemplified below), your independent verification and confirmation of product performance, reliability, etc. prior to use, must be necessary:
 - Use of our Products in any types of liquid, including water, oils, chemicals, and organic solvents
 - Use of our Products outdoors or in places where the Products are exposed to direct sunlight or dust
 - Use of our Products in places where the Products are exposed to sea wind or corrosive gases, including Cl₂, H₂S, NH₃, SO₂, and NO₂
 - Use of our Products in places where the Products are exposed to static electricity or electromagnetic waves
 - Use of our Products in proximity to heat-producing components, plastic cords, or other flammable items
 - Sealing or coating our Products with resin or other coating materials
 - Use of our Products without cleaning residue of flux (even if you use no-clean type fluxes, cleaning residue of flux is recommended); or Washing our Products by using water or water-soluble cleaning agents for cleaning residue after soldering
 - Use of the Products in places subject to dew condensation
- The Products are not subject to radiation-proof design.
- Please verify and confirm characteristics of the final or mounted products in using the Products.
- In particular, if a transient load (a large amount of load applied in a short period of time, such as pulse. is applied, confirmation of performance characteristics after on-board mounting is strongly recommended. Avoid applying power exceeding normal rated power; exceeding the power rating under steady-state loading condition may negatively affect product performance and reliability.
- De-rate Power Dissipation (Pd) depending on Ambient temperature (Ta). When used in sealed area, confirm the actual ambient temperature.
- Confirm that operation temperature is within the specified range described in the product specification.
- ROHM shall not be in any way responsible or liable for failure induced under deviant condition from what is defined in this document.

Precaution for Mounting / Circuit board design

- When a highly active halogenous (chlorine, bromine, etc.) flux is used, the residue of flux may negatively affect product performance and reliability.
- In principle, the reflow soldering method must be used; if flow soldering method is preferred, please consult with the ROHM representative in advance.

For details, please refer to ROHM Mounting specification

Precautions Regarding Application Examples and External Circuits

1. If change is made to the constant of an external circuit, please allow a sufficient margin considering variations of the characteristics of the Products and external components, including transient characteristics, as well as static characteristics.
2. You agree that application notes, reference designs, and associated data and information contained in this document are presented only as guidance for Products use. Therefore, in case you use such information, you are solely responsible for it and you must exercise your own independent verification and judgment in the use of such information contained in this document. ROHM shall not be in any way responsible or liable for any damages, expenses or losses incurred by you or third parties arising from the use of such information.

Precaution for Electrostatic

This Product is electrostatic sensitive product, which may be damaged due to electrostatic discharge. Please take proper caution in your manufacturing process and storage so that voltage exceeding the Products maximum rating will not be applied to Products. Please take special care under dry condition (e.g. Grounding of human body / equipment / solder iron, isolation from charged objects, setting of ionizer, friction prevention and temperature / humidity control).

Precaution for Storage / Transportation

1. Product performance and soldered connections may deteriorate if the Products are stored in the places where:
 - [a] the Products are exposed to sea winds or corrosive gases, including Cl₂, H₂S, NH₃, SO₂, and NO₂
 - [b] the temperature or humidity exceeds those recommended by ROHM
 - [c] the Products are exposed to direct sunshine or condensation
 - [d] the Products are exposed to high Electrostatic
2. Even under ROHM recommended storage condition, solderability of products out of recommended storage time period may be degraded. It is strongly recommended to confirm solderability before using Products of which storage time is exceeding the recommended storage time period.
3. Store / transport cartons in the correct direction, which is indicated on a carton with a symbol. Otherwise bent leads may occur due to excessive stress applied when dropping of a carton.
4. Use Products within the specified time after opening a humidity barrier bag. Baking is required before using Products of which storage time is exceeding the recommended storage time period.

Precaution for Product Label

QR code printed on ROHM Products label is for ROHM's internal use only.

Precaution for Disposition

When disposing Products please dispose them properly using an authorized industry waste company.

Precaution for Foreign Exchange and Foreign Trade act

Since our Products might fall under controlled goods prescribed by the applicable foreign exchange and foreign trade act, please consult with ROHM representative in case of export.

Precaution Regarding Intellectual Property Rights

1. All information and data including but not limited to application example contained in this document is for reference only. ROHM does not warrant that foregoing information or data will not infringe any intellectual property rights or any other rights of any third party regarding such information or data. ROHM shall not be in any way responsible or liable for infringement of any intellectual property rights or other damages arising from use of such information or data.:
2. No license, expressly or implied, is granted hereby under any intellectual property rights or other rights of ROHM or any third parties with respect to the information contained in this document.

Other Precaution

1. This document may not be reprinted or reproduced, in whole or in part, without prior written consent of ROHM.
2. The Products may not be disassembled, converted, modified, reproduced or otherwise changed without prior written consent of ROHM.
3. In no event shall you use in any way whatsoever the Products and the related technical information contained in the Products or this document for any military purposes, including but not limited to, the development of mass-destruction weapons.
4. The proper names of companies or products described in this document are trademarks or registered trademarks of ROHM, its affiliated companies or third parties.

General Precaution

1. Before you use our Products, you are requested to carefully read this document and fully understand its contents. ROHM shall not be in any way responsible or liable for failure, malfunction or accident arising from the use of any ROHM's Products against warning, caution or note contained in this document.
2. All information contained in this document is current as of the issuing date and subject to change without any prior notice. Before purchasing or using ROHM's Products, please confirm the latest information with a ROHM sales representative.
3. The information contained in this document is provided on an "as is" basis and ROHM does not warrant that all information contained in this document is accurate and/or error-free. ROHM shall not be in any way responsible or liable for any damages, expenses or losses incurred by you or third parties resulting from inaccuracy or errors of or concerning such information.

**Not Recommended for
New Designs**