

TECHNICAL CHARACTERISTICS

MATERIAL
 INSULATOR: LCP
 COLOR: BLACK
 CONTACT MATERIAL: COPPER ALLOY
 CONTACT TYPE: STAMPED
 CONTACT PLATING: SELECTIVE GOLD
 SHIELDING: BRASS TIN PLATED
 QUALITY CLASS: 1500 MATING CYCLES

ENVIRONMENTAL
 OPERATING TEMPERATURE: -40 UP TO 105°C
 FLAMABILITY RATING: UL94-V0
 COMPLIANCE: LEAD FREE AND ROHS

ELECTRICAL
 CURRENT RATING: 1.0 A max
 WORKING VOLTAGE: 30V
 INSULATOR RESISTANCE: >1000 MOHM
 DIELECTRIC WITHSTANDING VOLTAGE: 750V AC/MN
 CONTACT RESISTANCE: 20 mOHM MAX

STANDARD

CERTIFIED: E323964 / MODEL NUMBER 651-1428

SOLDERING
 REFLOW PROCESS ONLY

PACKAGING
 TAPE AND REEL

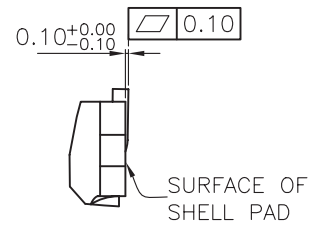
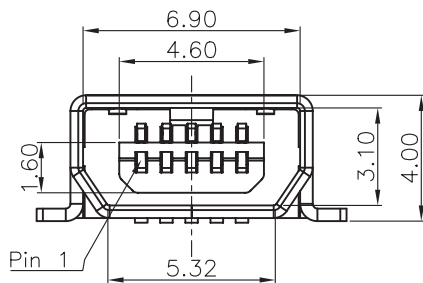

DETAIL A
 SCALE 2/1

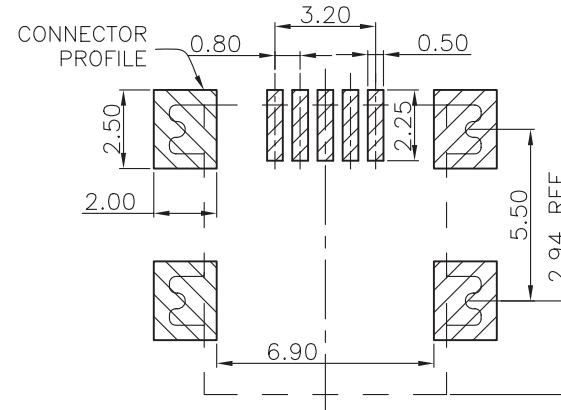

PCB LAYOUT - COMPONENT VIEW

RoHS Compliant			
G			
F			
E	18-FEB-13	DESIGNATION	AR
D	08-NOV-11	CURRENT RATING	GG
C	22-JUN-11	CURRENT RATING	GG
B	19-NOV-09	STANDARD	JP
A	31-JUL-08	PDF	CH
REV	DATE	FILE	BY

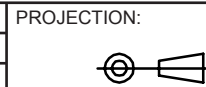

APPROVAL: RJ

GENERAL TOLERANCE

.X = +/- 0.2
 .XX = +/- 0.15



UNIT: MM

SCALE:

SHEET: 1/2

DRAW: PDJ

DESCRIPTION: MINI USB 2.0 SMT TYPE AB 5 CONTACTS

WERI PART NO: 651 305 142 821

SIZE

A4

1

2

3

4

5

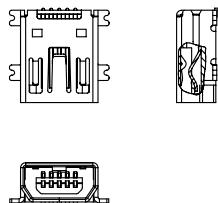

Note:

- 1.All dimensions meet EIA-481-3 requirements.
- 2.Material : Black Conductive Polystyrene Alloy
100% recyclable.
- 3.Thickness : 0.40±0.05mm
- 4.Component load per 13" reel :700 pcs.
- 5.Carton Size:350*350*296(mm)

A

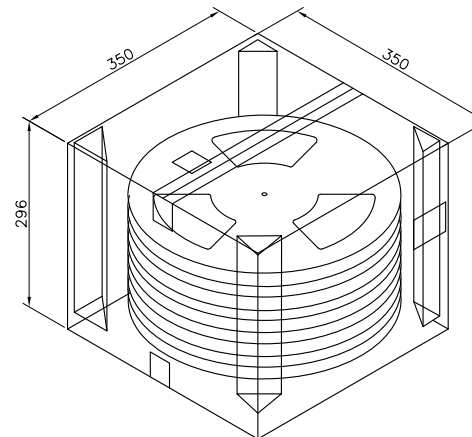
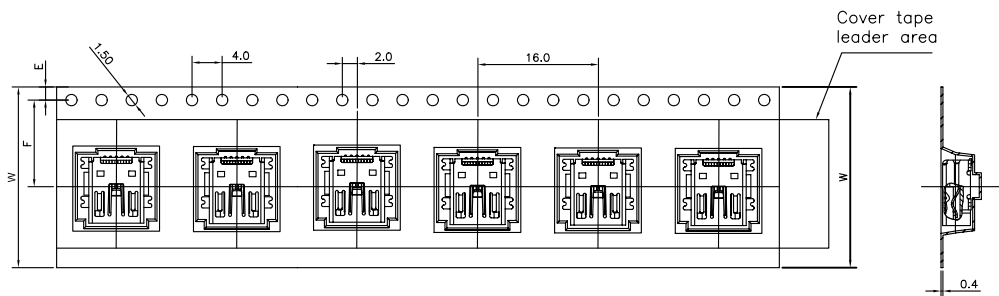

B

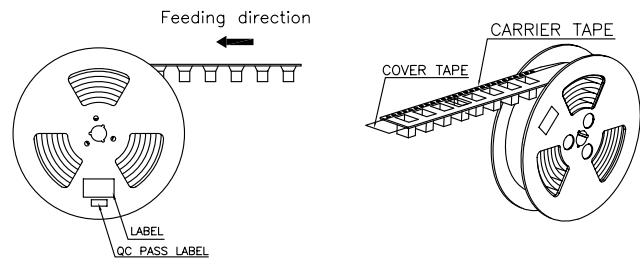
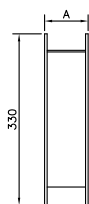

Pin No	W	A	PCS/R	R/CTN	Q'TY
05	24	29	700	9	9 *700

C

RoHS Compliant			
G			
F			
E			
D			
C			
B			
A	31-JUL-08	PDF	CH
REV	DATE	FILE	BY

PROJECTION:	
APPROVAL: RJ	

GENERAL TOLERANCE
.X = +/- 0.2
.XX = +/- 0.15
UNIT: MM
SCALE:
SHEET: 2/2
DRAW: PDJ



DESCRIPTION: MINI USB SMT TYPE AB 5 CONTACTS	SIZE A4
WERI PART NO: 651305142821	

D